

Broadcom NetXtreme II[®] Network Adapter User Guide

The information below is provided by the supplier of the referenced device without independent verification by Dell and is subject to the [Restrictions and Disclaimers](#) noted below.

● Introduction

- [Functionality and Features](#)
- [Teaming](#)
- [Virtual LANs \(VLANs\)](#)
- [Manageability](#)

● Installing the Hardware

● Installing the Driver Software

- [Broadcom Boot Agent Driver Software](#)
- [NDIS2 Driver Software](#)
- [Linux Driver Software](#)
- [Solaris Driver Software](#)
- [VMware Driver Software](#)

● Installing Windows Drivers and Management Applications

● Linux Management Application Installation

● iSCSI

● Advanced Teaming Concepts

● NIC Partitioning

● Fibre Channel Over Ethernet

● Data Center Bridging

● SR-IOV

● Using Broadcom Advanced Control Suite

● User Diagnostics

● Specifications

● Regulatory Information

● Troubleshooting

Information in this document is subject to change without notice.

© 2014 Broadcom Corporation. All rights reserved.

Trademarks used in this text: *Broadcom*, *NetXtreme II*, *Ethernet@Wirespeed*, *LiveLink*, and *Smart Load Balancing* are among the trademarks of Broadcom Corporation and/or its affiliates in the United States, certain other countries, and/or the EU. *Dell* and the *DELL* logo are trademarks of Dell Inc. *Microsoft* and *Windows* are trademarks of Microsoft Corporation. *Linux* is a trademark of Linus Torvalds. *Intel* is a trademark of Intel Corporation. *Magic Packet* is a trademark of Advanced Micro Devices, Inc. *Red Hat* is a trademark of Red Hat, Inc. *PCI Express* is a trademark of PCI-SIG. Any other trademarks or trade names mentioned are the property of their respective owners.

Restrictions and Disclaimers

The information contained in this document, including all instructions, cautions, and regulatory approvals and certifications, is provided by the supplier and has not been independently verified or tested by Dell, except where specifically noted. Dell

cannot be responsible for damage caused as a result of either following or failing to follow these instructions. All statements or claims regarding the properties, capabilities, speeds or qualifications of the part referenced in this document are made by the supplier and not by Dell. Dell specifically disclaims knowledge of the accuracy, completeness or substantiation for any such statements. All questions or comments relating to such statements or claims should be directed to the supplier.

Export Regulations

Customer acknowledges that these Products, which may include technology and software, are subject to the customs and export control laws and regulations of the United States ("U.S.") and may also be subject to the customs and export laws and regulations of the country in which the Products are manufactured and/or received. Customer agrees to abide by those laws and regulations. Further, under U.S. law, the Products may not be sold, leased or otherwise transferred to restricted end-users or to restricted countries. In addition, the Products may not be sold, leased or otherwise transferred to, or utilized by an end-user engaged in activities related to weapons of mass destruction, including without limitation, activities related to the design, development, production or use of nuclear weapons, materials, or facilities, missiles or the support of missile projects, and chemical or biological weapons.

Initial release: December 2005

Last revised: March 2014

2CSINGSRVT710-CDUM100-R

[Back to Contents Page](#)

Functionality and Features: Broadcom NetXtreme II® Network Adapter User Guide

[● Functional Description](#)[● Features](#)

Functional Description

The Broadcom NetXtreme II adapter is a new class of Gigabit Ethernet (GbE) and 10 GbE converged network interface controller (C-NIC) that can simultaneously perform accelerated data networking and storage networking on a standard Ethernet network. The C-NIC offers acceleration for popular protocols used in the data center, such as:

- TCP Offload Engine (TOE) for accelerating TCP over 1 GbE and 10 GbE
- Internet Small Computer Systems Interface (iSCSI) offload for accelerating network storage access featuring centralized boot functionality (iSCSI boot)
- Fibre Channel over Ethernet (FCoE) offload and acceleration for fibre channel block storage

 NOTE: Not all adapters support each listed protocol. Refer to the specific product data sheet for protocol support.

 NOTE: Separate licences are required for all offloading technologies.

Enterprise networks that use multiple protocols and multiple network fabrics benefit from the C-NICs ability to combine data communications, storage, and clustering over a single Ethernet fabric by boosting server CPU processing performance and memory utilization while alleviating I/O bottlenecks.

The Broadcom NetXtreme II adapter includes a 10/100/1000-Mbps or 10-Gbps Ethernet MAC with both half-duplex and full-duplex capability and a 10/100/1000-Mbps or 10-Gbps PHY. The transceiver is fully compatible with the IEEE 802.3 standard for auto-negotiation of speed.

Using the Broadcom teaming software, you can split your network into virtual LANs (VLANs) as well as group multiple network adapters together into teams to provide network load balancing and fault tolerance functionality. See [Configuring Teaming](#) and [Broadcom Gigabit Ethernet Teaming Services](#) for detailed information about teaming. See [Virtual LANs](#), for a description of VLANs. See [Configuring Teaming](#) for instructions on configuring teaming and creating VLANs on Windows operating systems.

Features

The following is a list of the Broadcom NetXtreme II adapter features. Some features may not be available on all adapters.

- TCP Offload Engine (TOE)
- Internet Small Computer Systems Interface (iSCSI) offload
- Fibre Channel over Ethernet (FCoE)
- NIC Partitioning
- Data Center Bridging (DCB)
 - Enhanced Transmission Selection (ETS; IEEE 802.1Qaz)
 - Priority-based Flow Control (PFC; IEEE 802.1Qbb)
 - Data Center Bridging Capability eXchange Protocol (DCBX; CEE version 1.01)
- Single-chip solution
 - Integrated 10/100/1000BASE-T transceivers
 - Integrated 10GBASE-T transceivers
 - 10/100/1000 triple-speed MAC
 - SerDes interface for optical transceiver connection

- PCI Express 1.0a x4 (Gigabit Ethernet)
 - o PCI Express Gen2 x8 (10 Gigabit Ethernet)
 - o Full fast-path TCP offload
 - o Zero copy capable hardware
- Other performance features
 - o TCP, IP, UDP checksum
 - o TCP segmentation
 - o Adaptive interrupts
 - o Receive Side Scaling (RSS)
- Manageability
 - o Broadcom Advanced Control Suite diagnostic and configuration software suite
 - o Supports PXE 2.0 specification (Linux Red Hat PXE Server, SUSE Linux Enterprise Server, Windows Server 2008, Windows Server 2008 R2, Windows Server 2012, Intel APITEST, DOS UNDI)
 - o Wake on LAN support
 - o Universal Management Port (UMP) support
 - o Statistics for SNMP MIB II, Ethernet-like MIB, and Ethernet MIB (IEEE Std 802.3z, Clause 30)
 - o SMBus controller
 - o ACPI 1.1a compliant (multiple power modes)
 - o IPMI support
- Advanced network features
 - o Jumbo frames (up to 9 KB). The OS and the link partner must support jumbo frames.
 - o Virtual LANs
 - o IEEE Std 802.3ad Teaming
 - o Smart Load Balancing Teaming
 - o Smart Load Balancing TOE Teaming (with the correct configuration)
 - o Flow Control (IEEE Std 802.3x)
 - o LiveLink™ (supported in both the 32-bit and 64-bit Windows operating systems)
- Logical Link Control (IEEE Std 802.2)
- Layer-2 Priority Encoding (IEEE Std 802.1p)
- High-speed on-chip RISC processor
- Up to 4 classes of service (CoS)
- Up to 4 send rings and receive rings
- Integrated 96 KB frame buffer memory
- Quality of Service (QoS)
- GMII/MII Management Interface
- Four unique MAC unicast addresses
- Support for multicast addresses via 128 bits hashing hardware function
- Serial flash NVRAM memory
- JTAG support
- PCI Power Management Interface (v1.1)
- 64-bit BAR support
- EM64T processor support
- 1.2 V core voltage, 0.13 µm process
- iSCSI Boot support
- Virtualization
 - o Microsoft

VMware

- Single Root I/O Virtualization (SRIOV)

TCP Offload Engine (TOE)

The TCP/IP protocol suite is used to provide transport services for a wide range of applications for the Internet, LAN, and for file transfer. Without the TCP Offload Engine, the TCP/IP protocol suite runs on the host CPU, consuming a very high percentage of its resources and leaving little resources for the applications. With the use of the Broadcom NetXtreme II adapter, the TCP/IP processing can be moved to hardware, freeing the CPU for more important tasks such as application processing.

The Broadcom NetXtreme II adapter's TOE functionality allows simultaneous operation of up to 1024 fully offloaded TCP connections for 1-Gbps network adapters and 1880 fully offloaded TCP connections for 10-Gbps network adapters. The TOE support on the adapter significantly reduces the host CPU utilization while preserving the implementation of the operating system stack.

Internet Small Computer Systems Interface (iSCSI)

The IETF has standardized the Internet Small Computer Systems Interface (iSCSI). SCSI is a popular protocol that enables systems to communicate with storage devices, using block-level transfer (i.e., address data stored on a storage device that is not a whole file). iSCSI maps the SCSI request/response application protocols and its standardized command set over TCP/IP networks.

As iSCSI utilizes TCP as its sole transport protocol, it greatly benefits from hardware acceleration of the TCP processing (i.e., use of a TOE). However, iSCSI as a Layer 5 protocol has additional mechanisms beyond the TCP layer. iSCSI processing can also be offloaded, thereby reducing CPU utilization even further.

The Broadcom NetXtreme II adapter targets best-system performance, maintains system flexibility to changes, and supports current and future OS convergence and integration. Therefore, the adapter's iSCSI offload architecture is unique as evident by the split between hardware and host processing.



NOTES: The iSCSI offload feature is not available for all Broadcom network adapters.

Fibre Channel over Ethernet

FCoE (Fibre Channel Backbone-5 (FC-BB-5)) allows Fibre Channel protocol to be transferred over Ethernet. FCoE preserves existing Fibre Channel infrastructure and capital investments. The following FCoE features are supported:

- Full stateful hardware FCoE offload
- Receiver classification of FCoE and FIP frames. FIP is the FCoE Initialization Protocol used to establish and maintain connections.
- Receiver CRC offload
- Transmitter CRC offload
- Dedicated queue set for Fibre Channel traffic
- Data Center Bridging (DCB) provides lossless behavior with Priority Flow Control (PFC)
- DCB allocates a share of link bandwidth to FCoE traffic with Enhanced Transmission Selection (ETS)



NOTES: FCoE is not available for all Broadcom network adapters.

Power Management

The adapter speed setting will link at the configured speed for WOL when the system is powered down.



NOTES:

- Dell supports WOL on only one adapter in the system at a time.
- For specific systems, see your system documentation for WOL support.
- WOL is supported in Broadcom NetXtreme II BCM5708 devices with silicon revisions of B2 or later. For more information, see [Limitations](#).

Adaptive Interrupt Frequency

The adapter driver intelligently adjusts host interrupt frequency based on traffic conditions to increase overall application throughput. When traffic is light, the adapter driver interrupts the host for each received packet, minimizing latency. When traffic is heavy, the adapter issues one host interrupt for multiple, back-to-back incoming packets, preserving host CPU cycles.

ASIC with Embedded RISC Processor

The core control for Broadcom NetXtreme II adapters resides in a tightly integrated, high-performance ASIC. The ASIC includes a RISC processor. This functionality provides the flexibility to add new features to the card and adapts it to future network requirements through software downloads. This functionality also enables the adapter drivers to exploit the built-in host offload functions on the adapter as host operating systems are enhanced to take advantage of these functions.

Broadcom Advanced Control Suite

Broadcom Advanced Control Suite (BACS) is an integrated utility that provides useful information about each network adapter that is installed in your system. The BACS utility also enables you to perform detailed tests, diagnostics, and analyses on each adapter, as well as to modify property values and view traffic statistics for each adapter.

Supported Operating Environments

The Broadcom NetXtreme II adapter has software support for the following operating systems:

- Microsoft® Windows® (32-bit and 64-bit extended)
- Linux® (32-bit and 64-bit extended)
- MS-DOS®
- ESX and ESXi Server (VMware)
- Oracle Solaris
- SCO® UnixWare®
- SCO OpenServer®

Network Link and Activity Indication

For copper-wire Ethernet connections, the state of the network link and activity is indicated by the LEDs on the RJ-45 connector, as described in [Table 1](#). For fiber optic Ethernet connections and SFP+, the state of the network link and activity is indicated by a single LED located adjacent to the port connector, as described in [Table 2](#). Broadcom Advanced Control Suite also provides information about the status of the network link and activity (see [Viewing Vital Signs](#)).

Table 1: Network Link and Activity Indicated by the RJ-45 Port LEDs

Port LED	LED Appearance	Network State
Link LED	Off	No link (cable disconnected)
	Continuously illuminated	Link
Activity LED	Off	No network activity
	Blinking	Network activity

Table 2: Network Link and Activity Indicated by the Port LED

LED Appearance	Network State
Off	No link (cable disconnected)
Continuously illuminated	Link
Blinking	Network activity

Please read all [Restrictions and Disclaimers](#).

[Back to Contents Page](#)

[Back to Contents Page](#)

Configuring Teaming in Windows Server: Broadcom NetXtreme II® Network Adapter User Guide

[Broadcom Advanced Server Program Overview](#)

[Load Balancing and Fault Tolerance](#)

 NOTE: This chapter describes teaming for adapters in Windows Server systems. For more information on a similar technology on Linux operating systems (called "Channel Bonding"), refer to your operating system documentation.

Broadcom Advanced Server Program Overview

Broadcom Advanced Server Program (BASP) is the Broadcom teaming software for the Windows family of operating systems. BASP settings are configured by Broadcom Advanced Control Suite (BACS) utility.

BASP provides heterogeneous support for adapter teaming to include all of the Broadcom NetXtreme and NetXtreme II adapters as well as Dell-shipping Intel NIC adapters/LOMs. BASP provides support for TOE teaming only for NetXtreme II adapters.

BASP supports four types of teams for Layer 2 teaming:

- Smart Load Balancing and Failover
- Link Aggregation (802.3ad)
- Generic Trunking (FEC/GEC)/802.3ad-Draft Static
- SLB (Auto-Fallback Disable)

BASP supports two types of teams for TOE teaming:

- Smart Load Balancing and Failover
- SLB (Auto-Fallback Disable)

For more information on network adapter teaming concepts, see [Broadcom Gigabit Ethernet Teaming Services](#).

 NOTE: Windows Server 2012 provides built-in teaming support, called NIC Teaming. It is not recommended that users enable teams through NIC Teaming and BASP at the same time on the same adapters.

Load Balancing and Fault Tolerance

Teaming provides traffic load balancing and fault tolerance (redundant adapter operation in the event that a network connection fails). When multiple Gigabit Ethernet network adapters are installed in the same system, they can be grouped into teams, creating a virtual adapter.

A team can consist of two to eight network interfaces, and each interface can be designated as a primary interface or a standby interface (standby interfaces can be used only in a [Smart Load Balancing™ and Failover](#) type of team, and only one standby interface can be designated per SLB team). If traffic is not identified on any of the adapter team member connections due to failure of the adapter, cable, switch port, or switch (where the teamed adapters are attached to separate switches), the load distribution is reevaluated and reassigned among the remaining team members. In the event that all of the primary adapters are down, the hot standby adapter becomes active. Existing sessions are maintained and there is no impact on the user.

 NOTE: Although a team can be created with one adapter, it is not recommended since this defeats the purpose of teaming. A team consisting of one adapter is automatically created when setting up VLANs on a single adapter, and this should be the only time when creating a team with one adapter.

Types of Teams

The available types of teams for the Windows family of operating systems are:

- Smart Load Balancing and Failover
- Link Aggregation (802.3ad) (TOE is not applicable)
- Generic Trunking (FEC/GEC)/802.3ad-Draft Static (TOE is not applicable)
- SLB (Auto-Fallback Disable)

Smart Load Balancing™ and Failover

Smart Load Balancing™ and Failover is the Broadcom implementation of load balancing based on IP flow. This feature supports balancing IP traffic across multiple adapters (team members) in a bidirectional manner. In this type of team, all adapters in the team have separate MAC addresses. This type of team provides automatic fault detection and dynamic failover to other team member or to a hot standby member. This is done independently of Layer 3 protocol (IP, IPX, NetBEUI); rather, it works with existing Layer 2 and 3 switches. No switch configuration (such as trunk, link aggregation) is necessary for this type of team to work.

NOTES:

- If you do not enable LiveLink™ when configuring SLB teams, disabling Spanning Tree Protocol (STP) or enabling Port Fast at the switch or port is recommended. This minimizes the downtime due to spanning tree loop determination when failing over. LiveLink mitigates such issues.
- TCP/IP is fully balanced and IPX balances only on the transmit side of the team; other protocols are limited to the primary adapter.
- If a team member is linked at a higher speed than another, most of the traffic is handled by the adapter with the higher speed rate.

Link Aggregation (802.3ad)

This mode supports link aggregation and conforms to the IEEE 802.3ad (LACP) specification. Configuration software allows you to dynamically configure which adapters you want to participate in a given team. If the link partner is not correctly configured for 802.3ad link configuration, errors are detected and noted. With this mode, all adapters in the team are configured to receive packets for the same MAC address. The outbound load-balancing scheme is determined by our BASP driver. The team link partner determines the load-balancing scheme for inbound packets. In this mode, at least one of the link partners must be in active mode.

 NOTE: Link Aggregation team type is not supported for TOE teaming.

Generic Trunking (FEC/GEC)/802.3ad-Draft Static

The Generic Trunking (FEC/GEC)/802.3ad-Draft Static type of team is very similar to the Link Aggregation (802.3ad) type of team in that all adapters in the team are configured to receive packets for the same MAC address. The Generic Trunking (FEC/GEC)/802.3ad-Draft Static type of team, however, does not provide LACP or marker protocol support. This type of team supports a variety of environments in which the adapter link partners are statically configured to support a proprietary trunking mechanism. For instance, this type of team could be used to support Lucent's OpenTrunk or Cisco's Fast EtherChannel (FEC). Basically, this type of team is a light version of the Link Aggregation (802.3ad) type of team. This approach is much simpler, in that there is not a formalized link aggregation control protocol (LACP). As with the other types of teams, the creation of teams and the allocation of physical adapters to various teams is done statically through user configuration software.

The Generic Trunking (FEC/GEC/802.3ad-Draft Static) type of team supports load balancing and failover for both outbound and inbound traffic.

 NOTE: Generic Trunking (FEC/GEC/802.3ad-Draft Static) team type is not supported for TOE teaming.

SLB (Auto-Fallback Disable)

The SLB (Auto-Fallback Disable) type of team is identical to the Smart Load Balancing and Failover type of team, with the following exception—when the standby member is active, if a primary member comes back on line, the team continues using the standby member, rather than switching back to the primary member.

All primary interfaces in a team participate in load-balancing operations by sending and receiving a portion of the total traffic. Standby interfaces take over in the event that all primary interfaces have lost their links.

Failover teaming provides redundant adapter operation (fault tolerance) in the event that a network connection fails. If the primary adapter in a team is disconnected because of failure of the adapter, cable, or switch port, the secondary team member becomes active, redirecting both inbound and outbound traffic originally assigned to the primary adapter. Sessions will be maintained, causing no impact to the user.

Limitations of Smart Load Balancing and Failover/SLB (Auto-Fallback Disable) Types of Teams

Smart Load Balancing™ (SLB) is a protocol-specific scheme. The level of support for IP, IPX, and NetBEUI protocols is listed in [Table 1](#).

Table 1: Smart Load Balancing

Operating System	Failover/Fallback — All Broadcom			Failover/Fallback — Multivendor		
Protocol	IP	IPX	NetBEUI	IP	IPX	NetBEUI
Windows Server 2008	Y	Y	N/S	Y	N	N/S
Windows Server 2008 R2	Y	Y	N/S	Y	N	N/S
Windows Server 2012	Y	Y	N/S	Y	N	N/S
Operating System	Load Balance — All Broadcom			Load Balance — Multivendor		
Protocol	IP	IPX	NetBEUI	IP	IPX	NetBEUI
Windows Server 2008	Y	Y	N/S	Y	N	N/S
Windows Server 2008 R2	Y	Y	N/S	Y	N	N/S
Windows Server 2012	Y	Y	N/S	Y	N	N/S

Legend Y = yes

N = no

N/S = not supported

The Smart Load Balancing type of team works with all Ethernet switches without having to configure the switch ports to any special trunking mode. Only IP traffic is load-balanced in both inbound and outbound directions. IPX traffic is load-balanced in the outbound direction only. Other protocol packets are sent and received through one primary interface only. Failover for non-IP traffic is supported only for Broadcom network adapters. The Generic Trunking type of team requires the Ethernet switch to support some form of port trunking mode (for example, Cisco's Gigabit EtherChannel or other switch vendor's Link Aggregation mode). The Generic Trunking type of team is protocol-independent, and all traffic should be load-balanced and fault-tolerant.

 **NOTE:** If you do not enable LiveLink™ when configuring SLB teams, disabling Spanning Tree Protocol (STP) or enabling Port Fast at the switch is recommended. This minimizes the downtime due to the spanning tree loop determination when failing over. LiveLink mitigates such issues.

Teaming and Large Send Offload/Checksum Offload Support

Large Send Offload (LSO) and Checksum Offload are enabled for a team only when all of the members support and are configured for the feature.

Please read all [Restrictions and Disclaimers](#).

[Back to Contents Page](#)

[Back to Contents Page](#)

Virtual LANs in Windows: Broadcom NetXtreme II® Network Adapter User Guide

- [VLAN Overview](#)
- [Adding VLANs to Teams](#)

VLAN Overview

Virtual LANs (VLANs) allow you to split your physical LAN into logical parts, to create logical segmentation of workgroups, and to enforce security policies for each logical segment. Each defined VLAN behaves as its own separate network with its traffic and broadcasts isolated from the others, increasing bandwidth efficiency within each logical group. Up to 64 VLANs (63 tagged and 1 untagged) can be defined for each Broadcom adapter on your server, depending on the amount of memory available in your system.

VLANs can be added to a team to allow multiple VLANs with different VLAN IDs. A virtual adapter is created for each VLAN added.

Although VLANs are commonly used to create individual broadcast domains and/or separate IP subnets, it is sometimes useful for a server to have a presence on more than one VLAN simultaneously. Broadcom adapters support multiple VLANs on a per-port or per-team basis, allowing very flexible network configurations.

Figure 1: Example of Servers Supporting Multiple VLANs with Tagging

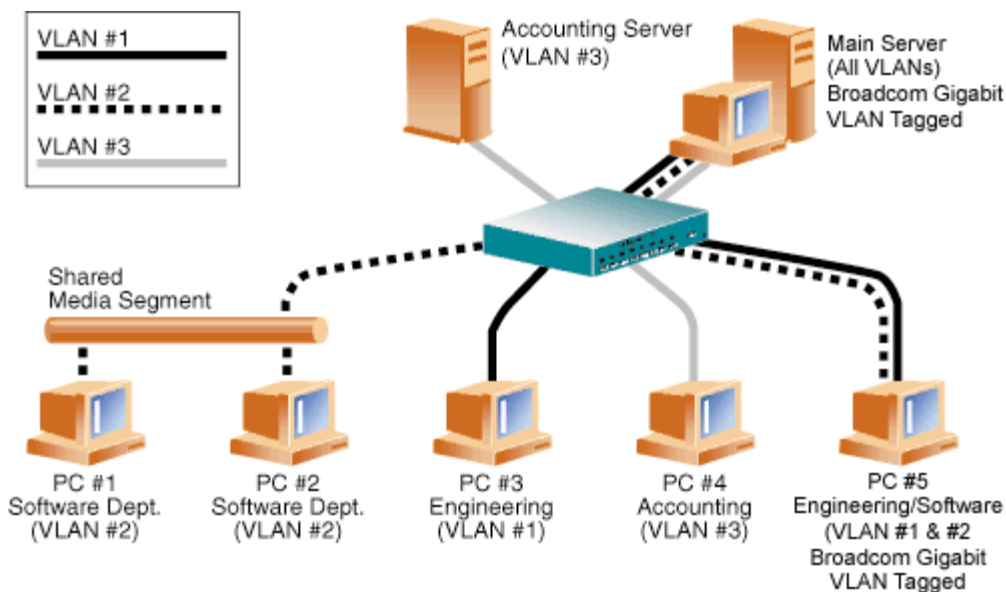



Figure 1 shows an example network that uses VLANs. In this example network, the physical LAN consists of a switch, two servers, and five clients. The LAN is logically organized into three different VLANs, each representing a different IP subnet. The features of this network are described in [Table 1](#).

Table 1: Example VLAN Network Topology

Component	Description
VLAN #1	An IP subnet consisting of the Main Server, PC #3, and PC #5. This subnet represents an engineering group.
VLAN #2	Includes the Main Server, PCs #1 and #2 via shared media segment, and PC #5. This VLAN is a software development group.
VLAN #3	Includes the Main Server, the Accounting Server and PC #4. This VLAN is an accounting group.
Main Server	A high-use server that needs to be accessed from all VLANs and IP subnets. The Main Server has a Broadcom adapter installed. All three IP subnets are accessed via the single physical adapter interface. The server is attached to one of the switch ports, which is configured for VLANs #1, #2, and #3. Both the adapter and the connected switch port have tagging turned on. Because of the tagging VLAN capabilities of both devices, the

	server is able to communicate on all three IP subnets in this network, but continues to maintain broadcast separation between all of them.
Accounting Server	Available to VLAN #3 only. The Accounting Server is isolated from all traffic on VLANs #1 and #2. The switch port connected to the server has tagging turned off.
PCs #1 and #2	Attached to a shared media hub that is then connected to the switch. PCs #1 and #2 belong to VLAN #2 only, and are logically in the same IP subnet as the Main Server and PC #5. The switch port connected to this segment has tagging turned off.
PC #3	A member of VLAN #1, PC #3 can communicate only with the Main Server and PC #5. Tagging is not enabled on PC #3 switch port.
PC #4	A member of VLAN #3, PC #4 can only communicate with the servers. Tagging is not enabled on PC #4 switch port.
PC #5	A member of both VLANs #1 and #2, PC #5 has a Broadcom adapter installed. It is connected to switch port #10. Both the adapter and the switch port are configured for VLANs #1 and #2 and have tagging enabled.

 NOTE: VLAN tagging is only required to be enabled on switch ports that create trunk links to other switches, or on ports connected to tag-capable end-stations, such as servers or workstations with Broadcom adapters.

Adding VLANs to Teams

Each team supports up to 64 VLANs (63 tagged and 1 untagged). Note that only Broadcom adapters and Alteon® AceNIC adapters can be part of a team with VLANs. With multiple VLANs on an adapter, a server with a single adapter can have a logical presence on multiple IP subnets. With multiple VLANs in a team, a server can have a logical presence on multiple IP subnets and benefit from load balancing and failover. For instructions on adding a VLAN to a team, see [Adding a VLAN](#) for Windows operating systems.

 NOTE: Adapters that are members of a failover team can also be configured to support VLANs. Because VLANs are not supported for an Intel LOM, if an Intel LOM is a member of a failover team, VLANs cannot be configured for that team.

Please read all [Restrictions and Disclaimers](#).

[Back to Contents Page](#)

[Back to Contents Page](#)

Manageability: Broadcom NetXtreme II® Network Adapter User Guide

- [CIM](#)
- [SNMP](#)
- [HBA API](#)

CIM

The Common Information Model (CIM) is an industry standard defined by the Distributed Management Task Force (DMTF). Microsoft implements CIM on Windows server platforms. Broadcom support CIM on Windows Server and Linux platforms.

 **NOTE:** For information on installing a CIM provider on Linux-based systems, see [Linux Management Application Installation](#).

Broadcom's implementation of CIM will provide various classes to provide information to users through CIM client applications. Note that Broadcom CIM data provider will provide data only, and users can choose their preferred CIM client software to browse the information exposed by Broadcom CIM provider.

Broadcom CIM provider provides information through BRCM_NetworkAdapter and BRCM_ExtraCapacityGroup classes. BRCM_NetworkAdapter class provides network adapter information pertaining to a group of adapters including Broadcom and other vendors' controllers. BRCM_ExtraCapacityGroup class provides team configuration for the Broadcom Advanced Server Program. Current implementation will provide team information and information of physical network adapters in the team.

Broadcom Advanced Server Program provides events through event logs. Users can use the "Event Viewer" provided by Windows server platforms, or use CIM to inspect or monitor these events. Broadcom CIM provider will also provide event information through the CIM generic event model. These events are __InstanceCreationEvent, __InstanceDeletionEvent and __InstanceModificationEvent, and are defined by CIM. CIM requires the client application to register the events from the client application, using queries as examples shown below in order to receive events properly.

```
SELECT * FROM __InstanceModificationEvent
where TargetInstance ISA "BRCM_NetworkAdapter"
SELECT * FROM __InstanceModificationEvent
where TargetInstance ISA "BRCM_ExtraCapacityGroup"
SELECT * FROM __InstanceCreationEvent
where TargetInstance ISA "BRCM_NetworkAdapter"
SELECT * FROM __InstanceDeletionEvent
where TargetInstance ISA "BRCM_NetworkAdapter"
SELECT * FROM __InstanceCreationEvent
where TargetInstance ISA "BRCM_ActsAsSpare"
SELECT * FROM __InstanceDeletionEvent
where TargetInstance ISA "BRCM_ActsAsSpare"
```

For detailed information about these events, see the CIM documentation at http://www.dmtf.org/sites/default/files/standards/documents/DSP0004V2.3_final.pdf.

Broadcom also implements the Storage Management Initiative-Specification (SMI-S), which defines CIM management profiles for storage systems.

SNMP

BASP Subagent

The BASP subagent, baspmgmt.dll, is designed for the Windows Server 2008 and Windows Server 2008 R2 SNMP service. It is required to install the SNMP service before installing the BASP subagent.

The BASP subagent allows an SNMP manager software to actively monitor the configurations and performance of the Broadcom Advanced Server features. The subagent also provides an alarm trap to an SNMP manager to inform the manager of any changes to the conditions of the BASP component.

The BASP subagent allows monitoring of the configurations and statistics for the BASP teams, the physical NIC adapters participating in a team, and the virtual NIC adapters created as the result of teaming. Non-teamed NIC adapters are not

monitored at this time. The BASP configuration data includes information such as team IDs, physical/virtual/VLAN/team adapter IDs, physical/virtual/VLAN/team/ adapter descriptions, and MAC addresses of the adapters.

The statistics include detailed information such as data packets transmitted and received for the physical/virtual/VLAN/team adapters.

The alarm trap forwards information about the changes in configuration of the physical adapters participating in a team, such as physical adapter link up/down, and adapter installed/removed events.

To monitor this information, an SNMP manager must load the Broadcom BASP MIB database files to allow monitoring of the information described above. These files, which are shown below, are included with the driver source media.

- baspcfg.mib
- baspstat.mib
- basptrap.mib

HBA API

Broadcom supports the Storage Networking Industry Association (SNIA) Common HBA API on Windows and Linux operating systems. The Common HBA API is an application program interface for the management of Fibre Channel Host Bus Adapters.

BASP Extensible-Agent

The Broadcom NetXtreme II Gigabit Ethernet Controller Extended Information SNMP extensible-agent (bcmif.dll) is designed for Windows Server 2008 SNMP service.

The extensible-agent allows the SNMP manager software to actively monitor the configurations of the Broadcom NetXtreme II adapter. It is intended to supplement the information already provided by the standard SNMP Management Network Interface information.

The extensible-agent provides in-depth information about a Broadcom NetXtreme II adapter such as:

- MAC address
- Bound IP address
- IP subnet mask
- Physical link status
- Adapter state
- Line speed
- Duplex mode
- Memory range
- Interrupt setting
- Bus number
- Device number
- Function number

To monitor this information, a SNMP manager needs to load the Broadcom Extended information MIB file to allow monitoring of the information described above. This file, bcmif.mib, is included on the installation CD.

The monitored workstation requires the installation of the Broadcom Extended Information SNMP extensible-agent, bcmif.dll, and requires the Microsoft Windows Server 2008 SNMP service to be installed and loaded.

Please read all [Restrictions and Disclaimers](#).

[Back to Contents Page](#)

[Back to Contents Page](#)

Installing the Hardware: Broadcom NetXtreme II® Network Adapter User Guide

- [Overview](#)
- [System Requirements](#)
- [Safety Precautions](#)
- [Preinstallation Checklist](#)
- [Installation of the Add-In NIC](#)

 **NOTE: Service Personnel:** This product is intended only for installation in a Restricted Access Location (RAL).

Overview

This section applies to Broadcom NetXtreme II add-in network interface cards.

System Requirements

Before you install a Broadcom NetXtreme II adapter, verify that your system meets the following hardware and operating system requirements:

Hardware Requirements

- IA32- or EMT64-based computer that meets operating system requirements
- One open PCI Express slot. Depending on the PCI Express support on your adapter, the slot may be of type PCI Express 1.0a x1, PCI Express 1.0a x4, or PCI Express Gen2 x8.
- 128-MB RAM (minimum)

Operating System Requirements

General

- PCI Express v1.0a, x1 (or greater) Host Interface

Microsoft Windows

One of the following versions of Microsoft Windows:

- Windows Server 2008 family
- Windows Server 2008 R2 family
- Windows Server 2012 family

Linux

Although the adapter driver should work with many Linux kernel versions and distributions, it has only been tested on 2.4x kernels (starting from 2.4.24) and 2.6.x kernels. The driver may not compile on kernels older than 2.4.24. Testing is concentrated on i386 and x86_64 architectures. Only limited testing has been done on other architectures. Minor changes to some source files and Makefile may be needed on some kernels.

VMware ESX

- VMware ESX

- VMware ESX 3.5
- VMware ESX 4.0
- VMware ESX 4.1
- VMware ESXi 5.0
- VMware ESXi 5.1

Safety Precautions

 **CAUTION!** The adapter is being installed in a system that operates with voltages that can be lethal. Before you open the case of your system, observe the following precautions to protect yourself and to prevent damage to the system components.

- Remove any metallic objects or jewelry from your hands and wrists.
- Make sure to use only insulated or nonconducting tools.
- Verify that the system is powered OFF and is unplugged before you touch internal components.
- Install or remove adapters in a static-free environment. The use of a properly grounded wrist strap or other personal antistatic devices and an antistatic mat is strongly recommended.

Preinstallation Checklist

1. Verify that your system meets the hardware and software requirements listed under [System Requirements](#).
2. Verify that your system is using the latest BIOS.

 **NOTE:** If you acquired the adapter software on a disk or from the Dell support website (<http://support.dell.com>), verify the path to the adapter driver files.

3. If your system is active, shut it down.
4. When system shutdown is complete, turn off the power and unplug the power cord.
5. Remove the adapter from its shipping package and place it on an antistatic surface.
6. Check the adapter for visible signs of damage, particularly on the edge connector. Never attempt to install a damaged adapter.

Installation of the Add-In NIC

The following instructions apply to installing the Broadcom NetXtreme II adapter (add-in NIC) in most systems. Refer to the manuals that were supplied with your system for details about performing these tasks on your particular system.

Installing the Add-In NIC

1. Review [Safety Precautions](#) and [Preinstallation Checklist](#). Before you install the adapter, ensure that the system power is OFF, the power cord is unplugged from the power outlet, and that you are following proper electrical grounding procedures.
2. Open the system case and select the slot based on the adapter, which may be of type PCIe 1.0a x1, PCIe 1.0a x4, PCIe Gen2 x8, or other appropriate slot. A lesser width adapter can be seated into a greater width slot (x1 in a x4), but a greater width adapter cannot be seated into a lesser width slot (x4 in a x1). If you do not know how to identify a PCI Express slot, refer to your system documentation.
3. Remove the blank cover-plate from the slot that you selected.
4. Align the adapter connector edge with the PCI Express connector slot in the system.
5. Applying even pressure at both corners of the card, push the adapter card into the slot until it is firmly seated. When the adapter is properly seated, the adapter port connectors are aligned with the slot opening, and the adapter faceplate is flush against the system chassis.

 **CAUTION!** Do not use excessive force when seating the card, as this may damage the system or the adapter. If you have difficulty seating the adapter, remove it, realign it, and try again.

6. Secure the adapter with the adapter clip or screw.

7. Close the system case and disconnect any personal antistatic devices.

Connecting the Network Cables

The Broadcom NetXtreme II adapter has either an RJ-45 connector used for attaching the system to an Ethernet copper-wire segment or a fiber optic connector for attaching the system to an Ethernet fiber optic segment.

 NOTE: This section does not apply to blade servers.

Copper Wire

 NOTE: The Broadcom NetXtreme II adapter supports Automatic MDI Crossover (MDIX), which eliminates the need for crossover cables when connecting machines back-to-back. A straight-through Category 5 cable allows the machines to communicate when connected directly together.

1. Select an appropriate cable. [Table 1](#) lists the copper cable requirements for connecting to 10/100/1000BASE-T and 10GBASE-T ports:

Table 1: 10/100/1000BASE-T and 10GBASE-T Cable Specifications

Port Type	Connector	Media	Maximum Distance
10BASE-T	RJ-45	Category 3, 4, or 5 unshielded twisted pairs (UTP)	100m (328 ft)
100/1000BASE-T ¹	RJ-45	Category 5 ² UTP	100m (328 ft)
10GBASE-T	RJ-45	Category 6 ³ UTP Category 6A ³ UTP	50m (164 ft) 100m (328 ft)

¹ 1000BASE-T signaling requires four twisted pairs of Category 5 balanced cabling, as specified in ISO/IEC 11801:2002 and ANSI/EIA/TIA-568-B.

² Category 5 is the minimum requirement. Category 5e and Category 6 are fully supported.

³ 10GBASE-T signaling requires four twisted pairs of Category 6 or Category 6A (augmented Category 6) balanced cabling, as specified in ISO/IEC 11801:2002 and ANSI/TIA/EIA-568-B.

2. Connect one end of the cable to the RJ-45 connector on the adapter.
3. Connect the other end of the cable to an RJ-45 Ethernet network port.

Please read all [Restrictions and Disclaimers](#).

[Back to Contents Page](#)

[Back to Contents Page](#)

Broadcom Boot Agent Driver Software: Broadcom NetXtreme II® Network Adapter User Guide

- [Overview](#)
- [Setting Up MBA in a Client Environment](#)
- [Setting Up MBA in a Server Environment](#)

Overview

Broadcom NetXtreme II adapters support Preboot Execution Environment (PXE), Remote Program Load (RPL), iSCSI, and Bootstrap Protocol (BootP). Multi-Boot Agent (MBA) is a software module that allows your network computer to boot with the images provided by remote servers across the network. The Broadcom MBA driver complies with the PXE 2.1 specification and is released with both monolithic and split binary images. This provides flexibility to users in different environments where the motherboard may or may not have built-in base code.

The MBA module operates in a client/server environment. A network consists of one or more boot servers that provide boot images to multiple computers through the network. The Broadcom implementation of the MBA module has been tested successfully in the following environments:

- **Linux Red Hat PXE Server.** Broadcom PXE clients are able to remotely boot and use network resources (NFS mount, and so forth) and to perform Linux installations. In the case of a remote boot, the Linux universal driver binds seamlessly with the Broadcom Universal Network Driver Interface (UNDI) and provides a network interface in the Linux remotely-booted client environment.
- **Intel APITEST.** The Broadcom PXE driver passes all API compliance test suites.
- **MS-DOS UNDI.** The MS-DOS Universal Network Driver Interface (UNDI) seamlessly binds with the Broadcom UNDI to provide a network adapter driver interface specification (NDIS2) interface to the upper layer protocol stack. This allows computers to connect to network resources in an MS-DOS environment.
- **Windows Deployment Service (WDS).** To extend functionalities beyond basic network connectivity when loading an operating system through WDS, see [Using the NetXtreme II Monolithic Driver](#).
- **Automated Deployment Service (ADS).** To extend functionalities beyond basic network connectivity when loading an operating system through ADS, see [Using the NetXtreme II Monolithic Driver](#).

Setting Up MBA in a Client Environment

Setting up MBA in a client environment involves the following steps:

1. Enabling the MBA driver.
2. Configuring the MBA driver.
3. Setting up the BIOS for the boot order.

Enabling the MBA Driver

To enable or disable the MBA driver:

1. Insert an MS-DOS 6.22 or Dell Real Mode Kernel bootable disk containing the uxdiag.exe file (for 10/100/1000-Mbps network adapters) or uediag.exe (for 10-Gbps network adapters) in the removable disk drive and power up your system.

 **NOTE:** The uxdiag.exe (or uediag.exe) file is on the installation CD or in the DOS Utilities package available from <http://support.dell.com/>.

1. Type:

```
uxdiag -mba [ 0-disable | 1-enable ] -c devnum
(or uediag -mba [ 0-disable | 1-enable ] -c devnum)
```

where

devnum is the specific device(s) number (0,1,2, ...) to be programmed.

Configuring the MBA Driver

This section pertains to configuring the MBA driver on add-in NIC models of the Broadcom network adapter. For configuring the MBA driver on LOM models of the Broadcom network adapter, check your system documentation.

 **NOTE:** You can use Broadcom's Comprehensive Configuration Management (CCM) utility or the uEFI to configure the MBA driver one adapter at a time as described below. Or you can use the MS-DOS based User Diagnostics application to simultaneously configure the MBA driver for multiple adapters.

Using CCM

1. Restart your system.
2. Press **CTRL+s** within 4 seconds after you are prompted to do so. A list of adapters displays.
 - a. Select the adapter to configure and press **Enter**. The Main Menu displays.
 - b. Select **MBA Configuration** to display the MBA Configuration menu.

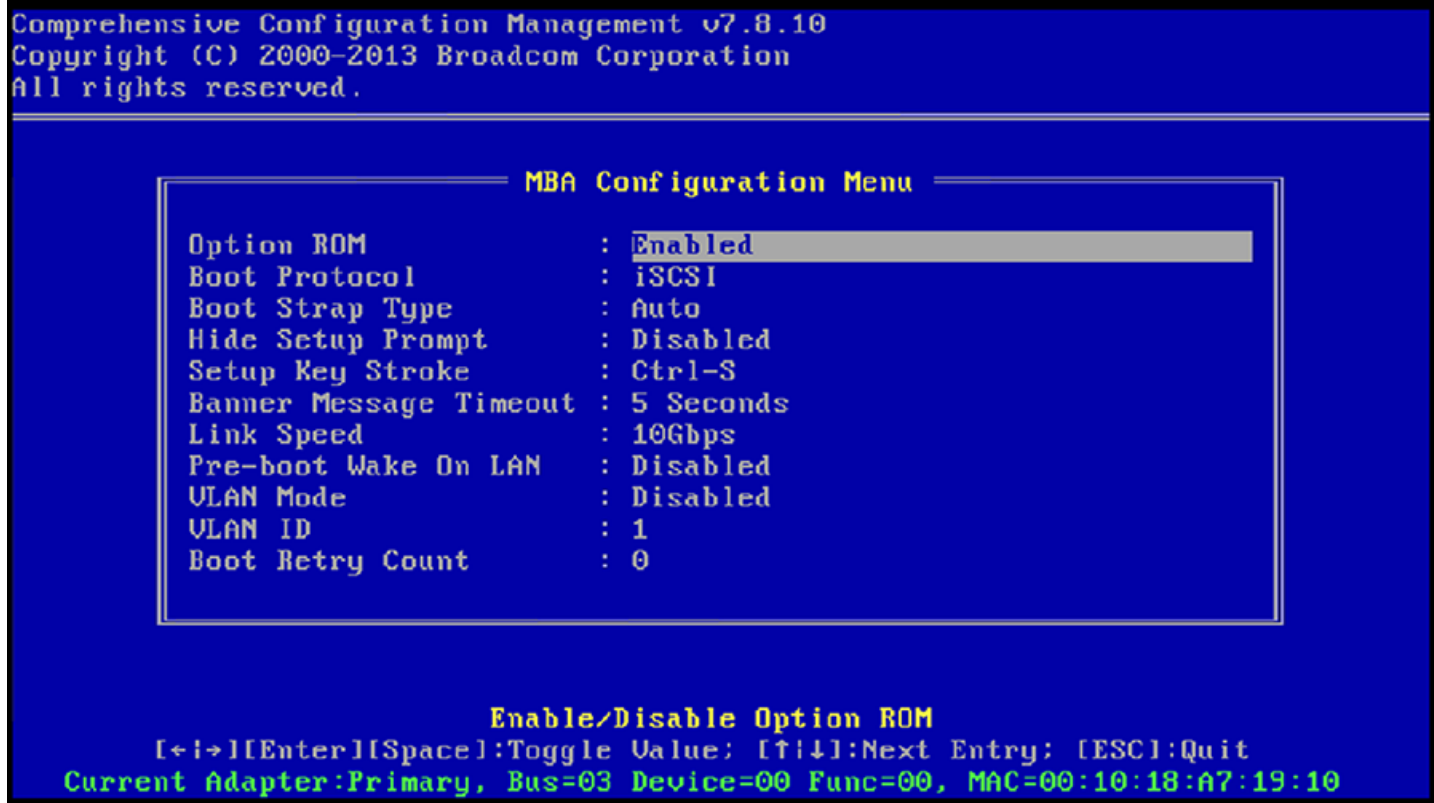

- Use the UP ARROW and DOWN ARROW keys to move to the Boot Protocol menu item. Then use the RIGHT ARROW or LEFT ARROW key to select the boot protocol of choice if other boot protocols besides Preboot Execution Environment (PXE) are available. If available, other boot protocols include Remote Program Load (RPL), iSCSI, and Bootstrap Protocol (BOOTP).

 NOTE: For iSCSI boot-capable LOMs, the boot protocol is set via the BIOS. See your system documentation for more information.

 NOTE: If you have multiple adapters in your system and you are unsure which adapter you are configuring, press **CTRL+F6**, which causes the port LEDs on the adapter to start blinking.

- Use the UP ARROW, DOWN ARROW, LEFT ARROW, and RIGHT ARROW keys to move to and change the values for other menu items, as desired.
- Press **F4** to save your settings.
- Press **ESC** when you are finished.

Using uEFI

- Restart your system.
- Enter the System Setup or Device Setting configuration menu.
- Select the device on which you want to change MBA settings.
- Select **MBA Configuration Menu**.
- Use the drop-down menu to select the boot protocol of choice, if boot protocols other than Preboot Execution Environment (PXE) are available. If available, other boot protocols include iSCSI, FCoE, and Bootstrap Protocol (BOOTP).

 NOTE: For iSCSI boot-capable LOMs, the boot protocol is set via the BIOS. See your system documentation for more information.

- Use the UP ARROW, DOWN ARROW, LEFT ARROW, and RIGHT ARROW keys to move to and change the values for other menu items, as desired.
- Select **Back** to go to Main menu
- Select **Finish** to save and exit.

Setting Up the BIOS

To boot from the network with the MBA, make the MBA enabled adapter the first bootable device under the BIOS. This procedure depends on the system BIOS implementation. Refer to the user manual for the system for instructions.

Setting Up MBA in a Server Environment

Red Hat Linux PXE Server

The Red Hat Enterprise Linux distribution has PXE Server support. It allows users to remotely perform a complete Linux installation over the network. The distribution comes with the boot images *boot kernel* (vmlinuz) and *initial ram disk* (initrd), which are located on the Red Hat disk#1:

```
/images/pxeboot/vmlinuz  
/images/pxeboot/initrd.img
```

Refer to the Red Hat documentation for instructions on how to install PXE Server on Linux.

The Initrd.img file distributed with Red Hat Enterprise Linux, however, does not have a Linux network driver for the Broadcom NetXtreme II adapters. This version requires a driver disk for drivers that are not part of the standard distribution. You can create a driver disk for the Broadcom NetXtreme II adapter from the image distributed with the installation CD. Refer to the Linux Readme.txt file for more information.

MS-DOS UNDI/Intel APITEST

To boot in MS-DOS mode and connect to a network for the MS-DOS environment, download the Intel PXE PDK from the Intel website. This PXE PDK comes with a TFTP/ProxyDHCP/Boot server. The PXE PDK can be downloaded from Intel at <http://downloadcenter.intel.com/SearchResult.aspx?lang=eng&ProductFamily=Network+Connectivity&ProductLine=Boot+Agent+Software&ProductProduct=Intel%c2%ae+Boot+Agent>.

Please read all [Restrictions and Disclaimers](#).

[Back to Contents Page](#)

[Back to Contents Page](#)

NDIS2 Driver Software: Broadcom NetXtreme II® Network Adapter User Guide

- [Overview](#)
- [Preinstallation Requirements](#)
- [Installing the NDIS2 Driver Software for Use on MS-DOS Platforms](#)
- [Using Keywords for the Drivers](#)

Overview

Two drivers are discussed in this section:

- BXND20X: Broadcom NetXtreme II Gigabit Ethernet driver
- BNX2EV: Broadcom NetXtreme II 10 Gigabit Ethernet driver

The examples used in this section refer to the BXND20X driver, but also apply to the BNX2EV driver.

Preinstallation Requirements

Before you can successfully install the NDIS2 driver software, the Broadcom network adapter must be physically installed in the server. Networking software that is appropriate to the operating system (such as Microsoft LAN Manager 2.2 for MS-DOS) must already be running on your server.

Installing the NDIS2 Driver Software for Use on MS-DOS Platforms

The NDIS2 driver software can be run from an MS-DOS startup disk using Microsoft Network Client 3.0 or from the hard disk using Microsoft LAN Manager 2.2.

Creating a Startup Disk to Run Microsoft Network Client

To perform this installation you must have the following items

- Windows NT Server 4.0 CD-ROM
- A blank MS-DOS system disk (3.5" high-density floppy disk)
- Access to the Broadcom NDIS2 driver file (BXND20X.dos). This file is located on the driver source media.

NOTES:

- Windows NT Server 4.0 users. When running Setup for Microsoft Network Client v3.0 for MS-DOS, click any network card from the list (NE2000 Compatible, for example) to create the startup disk.
- After creating the startup disk, follow the instructions in [Modifying the Startup Disk](#).

To create a startup disk

1. Create a folder called NCADMIN in the root of the C drive.
2. Copy the NCADMIN.CN_, NCADMIN.EX_, and NCADMIN.HL_ files from the I386 folder on the Windows NT Server 4.0 CD-ROM.
3. Open a command prompt window and change the directory to C:\NCADMIN.
4. Type `expand -r ncadmin.*` and press **ENTER**.
5. Close the command prompt window by typing `exit` and then pressing **ENTER**.
6. Start Windows Explorer.
7. Open the NCADMIN folder and double-click **ncadmin.exe**.

8. Follow the on-screen instructions to make the network startup disk (choose **NE2000 Compatible** from the list of adapters).

Modifying the Startup Disk

To modify the startup disk

1. Edit A:\Net\Protocol.ini with Notepad or a similar text editor.
 - a. Change DriverName=\$ to DriverName=BXND20X\$.
 - b. Remove all other parameter entries under the [MS\$NE2CLONE] or equivalent section such as IOBASE=0x300 or INTERRUPT=3, and so on.

Example Protocol.ini file for IP

```
[network.setup]
version=0x3110
netcard=ms$ne2clone,1,MS$NE2CLONE,1
transport=tcpip,TCPIP
lana0=ms$ne2clone,1,tcpip
[MS$NE2CLONE]
DriverName=BXND20X$
[protman]
DriverName=PROTMAN$
PRIORITY=MS$NDISHLP
[tcpip]
NBSessions=6
DefaultGateway=0
SubNetMask=255 0 0 0
IPAddress=192 168 0 1
DisableDHCP=0
DriverName=TCPIP$
BINDINGS=MS$NE2CLONE
LANABASE=0
```

Example Protocol.ini file for IPX

```
[network.setup]
version=0x3110
netcard=ms$ne2clone,1,MS$NE2CLONE,1
transport=ms$ndishlp,MS$NDISHLP
transport=ms$nwlink,MS$NWLINK
lana0=ms$ne2clone,1,ms$nwlink
lanal=ms$ne2clone,1,ms$ndishlp
[MS$NE2CLONE]
DriverName=BXND20X$
[protman]
DriverName=PROTMAN$
PRIORITY=MS$NDISHLP
[MS$NDISHLP]
DriverName=ndishlp$
BINDINGS=ms$ne2clone
[ms$nwlink]
DriverName=nwlink$
FRAME=Ethernet_802.2
BINDINGS=MS$NE2CLONE
LANABASE=0
```

Example Protocol.ini file for NetBEUI

```
[network.setup]
version=0x3110
netcard=ms$ne2clone,1,MS$NE2CLONE,1
transport=ms$ndishlp,MS$NDISHLP
transport=ms$netbeui,MS$NETBEUI
lana0=ms$ne2clone,1,ms$ndishlp
lanal=ms$ne2clone,1,ms$netbeui
[MS$NE2CLONE]
DriverName=BXND20X$
[protman]
DriverName=PROTMAN$
PRIORITY=MS$NDISHLP
[MS$NDISHLP]
DriverName=ndishlp$
BINDINGS=MS$NE2CLONE
[MS$NETBEUI]
DriverName=netbeui$
SESSIONS=10
NCBS=12
BINDINGS=MS$NE2CLONE
LANABASE=0
```

2. Edit A:\Net\System.ini.
 - a. Change netcard= to netcard=BXND20X.dos.
 - b. Check for references to C:\NET and change C:\NET to A:\NET if necessary.

Example System.ini file

```
[network]
sizeworkbuf=1498
filesharing=no
printsharing=no
autologon=yes
computername=MYPC
lanroot=A:\NET
username=USER1
workgroup=WORKGROUP
reconnect=yes
dospophotkey=N
lmlogon=0
logondomain=
preferredredir=basic
autostart=basic
maxconnections=8
[network drivers]
netcard=BXND20X.dos
transport=ndishlp.sys,*netbeui
devdir=A:\NET
LoadRMDrivers=yes
```

- Copy **BXND20X.dos** to A:\Net.
- Create the appropriate Autoexec.bat file in drive A for the chosen protocol as shown below.

For TCP/IP

```
path=a:\net
a:\net\net initialize
a:\net\netbind.com
a:\net\umb.com
a:\net\tcptsr.exe
a:\net\tinyrfc.exe
a:\net\nmtsr.exe
a:\net\emsbfr.exe
a:\net\net start basic
net use z: \\SERVERNAME\SHARENAME
```

For IPX

```
SET PATH=A:\NET
A:\NET\net initialize
A:\NET\nwlink
A:\NET\NET START BASIC
net use z: \\SERVERNAME\SHARENAME
```

For NetBEUI

```
SET PATH=A:\NET
A:\NET\NET START BASIC
net use z: \\SERVERNAME\SHARENAME
```

- Create a Config.sys file on the startup disk in drive A as shown below.

```
files=30
device=a:\net\ifshlp.sys
lastdrive=z
```

Installing the DOS NDIS2 Driver Software on the Hard Disk

To install the DOS NDIS2 Driver Software on the hard disk

- Verify that the system has Microsoft LAN Manager 2.2 installed, with a protocol such as NetBEUI configured.
- Create a folder on your hard disk to store the NDIS 2.01 driver.

Example: C:\LANMAN

- Copy the **BXND20X.dos** file to this folder.

Edit the **Config.sys** file by adding the following lines:

```
DEVICE = C:\LANMAN\PROTMAN.DOS
DEVICE = C:\LANMAN\BXND20X.DOS
DEVICE = C:\LANMAN\NETBEUI.DOS
```

- Edit the **Autoexec.bat** file by adding the following lines:

```
C:\ LANMAN\NETBIND.EXE
C:\LANMAN\NET START WORKSTATION
C:\LANMAN\NET USE drive letter: \\server name\resource name
```

- Edit the **Protocol.ini** file (located in C:\LANMAN) to configure the driver to bind with NetBEUI or any other protocols.

Example:

```
[PROTOCOL MANAGER]
DriverName = PROTMAN$
```

```
[NETBEUI_XIF]
DriverName = netbeui$
BINDINGS = BXND20X
[BXND20X]
DriverName = "BXND20X$"
```

- Restart the computer to complete the installation.

 **NOTE:** The driver loads during system configuration and displays the Broadcom banner, controller name, MAC address, IRQ number, detected line speed, and the controller BusNum and DevNum. If the driver fails to load, an *initialization fail* message is displayed.

Using Keywords for the Drivers

The Protocol.ini file contains certain keywords that are used by the BXND20X.dos AND BXND20X.dos drivers. These keywords are listed below:

BusNum. Specifies the number of the PCI bus on which the network adapter is located. Requires a decimal number having a value ranging from 0 to 255.

DevNum. Specifies the device number assigned to the network adapter when it is configured by the PCI BIOS. Requires a decimal number having a value ranging from 0 to 255.

FuncNum or PortNum. Specifies the PCI function or port number assigned to the network controller. Requires a decimal number having a value ranging from 0 to 7.

 **NOTE:** These keywords, **BusNum**, **DevNum**, and **FuncNum** (or **PortNum**) are needed when multiple adapters are installed in the server and when a specific controller must be loaded in a certain order. These keywords are used concurrently and are included for manufacturing purposes. Do not use them unless you are familiar with how to configure PCI devices. A PCI device scan utility is needed to find this information.

LineSpeed. Specifies the speed of the network connection in Mbit/s. Requires the decimal number 10, 100, or 1000. Technically, a line speed of 1000 Mbit/s cannot be forced and is achievable only through auto-negotiation. For the sake of simplicity, the driver performs auto-negotiation when the line speed is set to a value of 1000.

 **NOTE:** LineSpeed is not available with the Broadcom NetXtreme II 10 Gigabit Ethernet driver.

Duplex. Specifies the duplex mode of the network adapter. Requires a setting of either **Half** or **Full**. When this keyword is used, the **LineSpeed** keyword must also be used. If neither keyword is used, the network adapter defaults to auto-negotiation mode.

 **NOTE:** LineSpeed is not available with the Broadcom NetXtreme II 10 Gigabit Ethernet driver.

NodeAddress. Specifies the network address used by the network adapter. If a multicast address or a broadcast address is specified, the adapter uses the default MAC address.

Example:

```
[BXND20X]
DriverName = "BXND20X$"
BusNum = 3
DevNum = 14
PortNum = 2
LineSpeed = 1000
Duplex = Full
NodeAddress = 001020304050
```

FixChecksumOff. Turns off the driver's workaround for the TCP/IP stack to recognize the 1s complemented version of the checksum.

AcceptAllIMC. Informs the driver to deliver all multicast packets to the upper protocol.

Please read all [Restrictions and Disclaimers](#).

[Back to Contents Page](#)

[Back to Contents Page](#)

Linux Driver Software: Broadcom NetXtreme II® Network Adapter User Guide

- [Introduction](#)
- [Limitations](#)
- [Packaging](#)
- [Installing Linux Driver Software](#)
- [Unloading/Removing the Linux Driver](#)
- [Patching PCI Files \(Optional\)](#)
- [Network Installations](#)
- [Setting Values for Optional Properties](#)
- [Driver Defaults](#)
- [Driver Messages](#)
- [Teaming with Channel Bonding](#)
- [Remote PHY Support](#)
- [Statistics](#)
- [Linux iSCSI Offload](#)

Introduction

This section discusses the Linux drivers for the Broadcom NetXtreme II network adapters.

Table 1: Broadcom NetXtreme II Linux Drivers

Linux Driver	Description
bnx2	Linux driver for the NetXtreme II 1 Gb network adapters.
bnx2x	Linux driver for the NetXtreme II 10 Gb network adapters. This driver directly controls the hardware and is responsible for sending and receiving Ethernet packets on behalf of the Linux host networking stack. This driver also receives and processes device interrupts, both on behalf of itself (for L2 networking) and on behalf of the bnx2fc (FCoE) and cnic drivers.
cnic	The cnic driver provides the interface between Broadcom's upper layer protocol (e.g., storage) drivers and Broadcom's NetXtreme II 1 Gb and 10 Gb network adapters. The CNIC module works with the bnx2 and bnx2x network drives in the downstream and the bnx2fc (FCoE) and bnx2i (iSCSI) drivers in the upstream.
bnx2i	Linux iSCSI HBA driver to enable iSCSI offload on the NetXtreme II 1 Gb and 10 Gb network adapters.
bnx2fc	Linux FCoE kernel mode driver used to provide a translation layer between the Linux SCSI stack and the Broadcom FCoE firmware/hardware. In addition, the driver interfaces with the networking layer to transmit and receive encapsulated FCoE frames on behalf of open-fcoe's libfc/libfcoe for FIP/device discovery.

Limitations

- [bnx2 Driver](#)
- [bnx2x Driver](#)
- [bnx2i Driver](#)

bnx2 Driver

The current version of the driver has been tested on all 2.6.x kernels. Testing is concentrated on i386 and x86_64 architectures. Only limited testing has been done on other architectures. Minor changes to some source files and Makefile may be needed on some kernels. Additionally, the Makefile will not compile the cnic driver on kernels older than 2.6.16. iSCSI offload is only supported on 2.6.16 and newer kernels.

 **NOTE:** For Broadcom NetXtreme II BCM5708 devices with a silicon revision prior to B2, the open source bnx2 driver does not support the reporting and configuration of NetXtreme II WOL settings via ethtool. For silicon revisions of B2 or later, the bnx2 driver reports support for Magic Packet WOL via ethtool. Enabling support via ethtool is mandatory to successfully wake the system. To determine the silicon revision of your Broadcom NetXtreme II device, use the `lspci` command, where "10" = revision B0, "11" = revision B1, and "12" = revision B2.

bnx2x Driver

The current version of the driver has been tested on 2.6.x kernels starting from 2.6.9. The driver may not compile on kernels older than 2.6.9. Testing is concentrated on i386 and x86_64 architectures. Only limited testing has been done on some other architectures. Minor changes to some source files and Makefile may be needed on some kernels.

bnx2i Driver

The current version of the driver has been tested on 2.6.x kernels, starting from 2.6.18 kernel. The driver may not compile on older kernels. Testing is concentrated on i386 and x86_64 architectures, Red Hat EL5, and SUSE 11 SP1 distributions.

Packaging

The Linux drivers are released in the following packaging formats:

DKMS Packages

- `netxtreme2-version.dkms.noarch.rpm`
- `netxtreme2-version.dkms.src.rpm`

KMP Packages

- SLES
 - `broadcom-netxtreme2-kmp-[kernel]-version.i586.rpm`
 - `broadcom-netxtreme2-kmp-[kernel]-version.x86_64.rpm`
- Red Hat
 - `kmod-kmp-netxtreme2-{kernel}-version.i686.rpm`
 - `kmod-kmp-netxtreme2-{kernel}-version.x86_64.rpm`

The Broadcom Advanced Control Suite management utility is also distributed as an RPM package (`BACS-{version}.{arch}.rpm`). See [Linux BACS Installation](#) for information on installing Linux BACS.

Source Packages

Identical source files to build the driver are included in both RPM and TAR source packages. The supplemental tar file contains additional utilities such as patches and driver diskette images for network installation.

The following is a list of included files:

- **netxtreme2-version.src.rpm**: RPM package with NetXtreme II `bnx2/bnx2x/cnic/bnx2fc/bnx2ilibfc/libfcoe` driver source.
- **netxtreme2-version.tar.gz**: tar zipped package with NetXtreme II `bnx2/bnx2x/cnic/bnx2fc/bnx2i/libfc/libfcoe` driver source.
- **iscsiuio-version.tar.gz**: iSCSI user space management tool binary.
- **open-fcoe-*.brcm.<subvert>.<arch>.rpm**: open-fcoe userspace management tool binary RPM for SLES11 SP2 and legacy versions.
- **fcoe-utils-*.brcm.<subver>.<arch>.rpm**: open-fcoe userspace management tool binary RPM for RHEL 6.4 and legacy versions.

The Linux driver has a dependency on open-fcoe userspace management tools as the front-end to control FCoE interfaces. The package name of the open-fcoe tool is *fcoe-utils* for RHEL 6.4 and *open-fcoe* for SLES11 SP2 and legacy versions.

Installing Linux Driver Software

- [Installing the Source RPM Package](#)
- [Building the Driver from the Source TAR File](#)
- [Installing the Binary DKMS RPM Driver Package](#)
- [Installing the Binary DKMS RPM Driver Package](#)

 **NOTE:** If a *bnx2/bnx2x/bnx2i* driver is loaded and the Linux kernel is updated, the driver module must be recompiled if the driver module was installed using the source RPM or the TAR package. This does not apply to the source DKMS RPM.

Installing the Source RPM Package

The following are guidelines for installing the driver source RPM Package.

Prerequisites:

- Linux kernel source
- C compiler

Procedure:

1. Install the source RPM package:

```
rpm -ivh netxtreme2-<version>.src.rpm
```
2. Change the directory to the RPM path and build the binary RPM for your kernel:

For RHEL:

```
cd ~/rpmbuild
rpmbuild -bb SPECS/netxtreme2.spec
```

For SLES:

```
cd /usr/src/packages
rpmbuild -bb SPECS/netxtreme2.spec
```

3. Install the newly compiled RPM:

```
rpm -ivh RPMS/<arch>/netxtreme2-<version>.<arch>.rpm
```

Note that the `--force` option may be needed on some Linux distributions if conflicts are reported.

1. Install the open-fcoe utility.

For RHEL 6.4 and legacy versions, either of the following:

```
yum install fcoe-utils-<version>.rhel.64.brcm.<subver>.<arch>.rpm
```

-or-

```
rpm -ivh fcoe-utils-<version>.rhel.64.brcm.<subver>.<arch>.rpm
```

For SLES11 SP2:

```
rpm -ivh open-fcoe-<version>.sles.sp2.brcm.<subver>.<arch>.rpm
```

For RHEL 6.4 and SLES11 SP2 and legacy versions, the version of *fcoe-utils/open-fcoe* included in your distribution is sufficient and no out of box upgrades are provided.

Where available, installation with *yum* will automatically resolve dependencies. Otherwise, required dependencies can be located on your O/S installation media.

2. For SLES, turn on the *fcoe* and *lldpad* services.

For SLES11 SP1:

```
chkconfig lldpad on
```

```
chkconfig fcoe on
```

For SLES11 SP2:

```
chkconfig boot.lldpad on
chkconfig boot.fcoe on
```

3. Inbox drivers are included with all of the supported operating systems. The simplest means to ensure the newly installed drivers are loaded is to reboot.
4. After rebooting, create configuration files for all FCoE ethX interfaces:

```
cd /etc/fcoe
cp cfg-ethx cfg-<ethX FCoE interface name>
```

 **NOTE:** Note that your distribution might have a different naming scheme for Ethernet devices. (i.e., pXpX or emX instead of ethX).

5. Modify /etc/fcoe/cfg-<interface> by setting DCB_REQUIRED=yes to DCB_REQUIRED=no.
6. Turn on all ethX interfaces.
7. For SLES, use YaST to configure your Ethernet interfaces to automatically start at boot by setting a static IP address or enabling DHCP on the interface.
8. Disable lldpad on Broadcom CNA interfaces. This is required because Broadcom utilizes an offloaded DCBX client.
9. Make sure /var/lib/lldpad/lldpad.conf is created and each <ethX> block does not specify "adminStatus" or if specified, it is set to 0 ("adminStatus=0") as below.

```
lldp :
{
  eth5 :
  {
    tlv00000001 :
    {
      info = "04BC305B017B73";
    };
    tlv00000002 :
    {
      info = "03BC305B017B73";
    };
  };
};
```

10. Restart lldpad service to apply new settings

For SLES11 SP1, RHEL 6.4 and legacy versions:

```
service lldpad restart
```

For SLES11 SP2:

```
rclldpad restart
```

11. Restart fcoe service to apply new settings

For SLES11 SP1, RHEL 6.4, and legacy versions:

```
service fcoe restart
```

For SLES11 SP2:

```
rcfcoe restart
```

Installing the KMP Package

 **NOTE:** The examples in this procedure refer to the bnx2x driver, but also apply to the bnx2 and bnx2i drivers.

1. Install the KMP package:

```
rpm -ivh <file>
rmmmod bnx2x
```

2. Load the driver:

```
modprobe bnx2x
```

Building the Driver from the Source TAR File

 **NOTE:** The examples used in this procedure refer to the bnx2 driver, but also apply to the bnx2x driver.

1. Create a directory and extract the TAR files to the directory:

```
tar xvzf netxtreme2-version.tar.gz
```

- Build the driver `bnx2.ko` (or `bnx2i.ko`) as a loadable module for the running kernel:

```
cd netxtreme2-version
make
```

- Test the driver by loading it (first unload the existing driver, if necessary):

```
rmmod bnx2 (or bnx2x, or bnx2i)
insmod bnx2/src/bnx2.ko (or bnx2x/src/bnx2x.ko, or bnx2i/src/bnx2i.ko)
```

Verify that your network adapter supports iSCSI by checking the message log. If the message "bnx2i: dev eth0 does not support iSCSI" appears in the message log after loading the `bnx2i` driver, then iSCSI is not supported. This message may not appear until the interface is opened, as with:

```
ifconfig eth0 up
```

- Load the `cnic` driver (if applicable):

```
insmod cnic.ko
```

- Install the driver and man page:

```
make install
```

 NOTE: See the RPM instructions above for the location of the installed driver.

- Install the user daemon (`brcm_iscsiui`).

Refer to [Load and Run Necessary iSCSI Software Components](#) for instructions on loading the software components required to use the Broadcom iSCSI offload feature.

To configure the network protocol and address after building the driver, refer to the manuals supplied with your operating system.

Installing the Binary DKMS RPM Driver Package

Dynamic Kernel Module Support (DKMS) is designed to simplify the rebuilding of modules whenever you upgrade the kernel. This is accomplished by creating a framework where a kernel-dependent module source can reside.

To install the binary DKMS RPM driver package

- Download the binary DKMS RPM (`dkms-version.noarch.rpm`) from <http://linux.dell.com/dkms/>.

- Install the binary DKMS RPM package:

```
rpm -ivh dkms-version.noarch.rpm
```

- Install the DKMS RPM driver package:

```
rpm -ivh netxtreme2-version dkms.noarch.rpm
```

Verify that your network adapter supports iSCSI by checking the message log. If the message "bnx2i: dev eth0 does not support iSCSI" appears in the message log after loading the `bnx2i` driver, then iSCSI is not supported. This message may not appear until the interface is opened, as with:

```
ifconfig eth0 up
```

- To use Broadcom iSCSI, refer to [Load and Run Necessary iSCSI Software Components](#) to load the necessary software components.

For more information, go to <http://linux.dell.com>.

Installing the Binary KMOD/KMP Driver Package

To install the binary KMOD/KMP driver package

- Install the KMOD/KMP RPM driver package:

- SUSE: `rpm -ivh broadcom-netxtreme2-kmp-[kernel]-version.x86_64.rpm`
- Red Hat: `kmod-kmp-netxtreme2-{kernel}-version.x86_64.rpm`

Verify that your network adapter supports iSCSI by checking the message log. If the message "bnx2i: dev eth0 does not support iSCSI" appears in the message log after loading the `bnx2i` driver, then iSCSI is not supported. This message may not appear until the interface is opened, as with:

```
ifconfig eth0 up
```

- To use Broadcom iSCSI, refer to [Load and Run Necessary iSCSI Software Components](#) to load the necessary software components.

For more information, go to <http://linux.dell.com>.

Load and Run Necessary iSCSI Software Components

The Broadcom iSCSI Offload software suite consists of three kernel modules and a user daemon. Required software components can be loaded either manually or through system services.

1. Unload the existing driver, if necessary:

Manual:

```
rmmmod bnx2i
```

2. Load the iSCSI driver:

Manual:

```
insmod bnx2i.ko
```

or

```
modprobe bnx2i
```

Unloading/Removing the Linux Driver

- [Unloading/Removing the Driver from an RPM Installation](#)

- [Removing the Driver from a TAR Installation](#)

Unloading/Removing the Driver from an RPM Installation

NOTES:

- o The examples used in this procedure refer to the bnx2 driver, but also apply to the bnx2x driver.
- o On 2.6 kernels, it is not necessary to bring down the eth# interfaces before unloading the driver module.
- o If the cnic driver is loaded, unload the cnic driver before unloading the bnx2 driver.
- o Prior to unloading the bnx2i driver, disconnect all active iSCSI sessions to targets.

To unload the driver, use ifconfig to bring down all eth# interfaces opened by the driver, and then type the following:

```
rmmmod bnx2
```

 NOTE: The above command will also remove bnx2, bnx2x, and cnic modules.

If the driver was installed using RPM, do the following to remove it:

```
rpm -e netxtreme2
```

Removing the Driver from a TAR Installation

 NOTE: The examples used in this procedure refer to the bnx2 driver, but also apply to the bnx2x and bnx2i drivers.

If the driver was installed using make install from the tar file, the bnx2.ko driver file has to be manually deleted from the operating system. See [Installing the Source RPM Package](#) for the location of the installed driver.

Uninstalling BACS

RPM Package

Use the following command:

```
% rpm -e BACS
```

Patching PCI Files (Optional)

 NOTE: The examples used in this procedure refer to the bnx2 driver, but also apply to the bnx2x and bnx2i drivers.

For hardware detection utilities such as Red Hat kudzu to properly identify bnx2 supported devices, a number of files containing PCI vendor and device information may need to be updated.

Apply the updates by running the scripts provided in the supplemental tar file. For example, on Red Hat Enterprise Linux, apply the updates by doing the following:

```
./patch_pcitbl.sh /usr/share/hwdata/pcitable pci.updates
/usr/share/hwdata/pcitable.new bnx2
./patch_pciids.sh /usr/share/hwdata/pci.ids pci.updates
/usr/share/hwdata/pci.ids.new
```

Next, the old files can be backed up and the new files can be renamed for use.

```
cp /usr/share/hwdata/pci.ids /usr/share/hwdata/old.pci.ids
cp /usr/share/hwdata/pci.ids.new /usr/share/hwdata/pci.ids
cp /usr/share/hwdata/pcitable /usr/share/hwdata/old.pcitable
cp /usr/share/hwdata/pcitable.new /usr/share/hwdata/pcitable
```

Network Installations

For network installations through NFS, FTP, or HTTP (using a network boot disk or PXE), a driver disk that contains the bnx2/bnx2x driver may be needed. The driver disk images for the most recent Red Hat and SuSE versions are included. Boot drivers for other Linux versions can be compiled by modifying the Makefile and the make environment. Further information is available from the Red Hat website, <http://www.redhat.com>.

Setting Values for Optional Properties

Optional properties exist for the different drivers:

- [bnx2 Driver](#)
- [bnx2x Driver](#)
- [bnx2i Driver](#)

bnx2 Driver

disable_msi

The **disable_msi** optional property can be supplied as a command line argument to the insmod or modprobe command. The property can also be set in modprobe.conf. See the man page for more information. All other driver settings can be queried and changed using the ethtool utility. See the ethtool man page for more information. The ethtool settings do not persist across a reboot or module reload. The ethtool commands can be put in a startup script such as /etc/rc.local to preserve the settings across a reboot.

 NOTE: Some combinations of property values may conflict and result in failures. The driver cannot detect all such conflicting combinations.

This property is used to disable Message Signal Interrupts (MSI), and the property is valid only on 2.6 kernels that support MSI. By default, the driver enables MSI if it is supported by the kernel. It runs an interrupt test during initialization to determine if MSI is working. If the test passes, the driver enables MSI. Otherwise, it uses legacy INTx mode.

```
insmod bnx2.ko disable_msi=1
```

or

```
modprobe bnx2 disable_msi=1
```

bnx2x Driver

disable_tpa

The **disable_tpa** parameter can be supplied as a command line argument to disable the Transparent Packet Aggregation

(TPA) feature. By default, the driver will aggregate TCP packets. Use `disable_tpa` to disable the advanced TPA feature.

Set the **`disable_tpa`** parameter to 1 as shown below to disable the TPA feature on all NetXtreme II network adapters in the system. The parameter can also be set in `modprobe.conf`. See the man page for more information.

```
insmod bnx2x.ko disable_tpa=1
```

or

```
modprobe bnx2x disable_tpa=1
```

`int_mode`

The **`int_mode`** parameter is used to force using an interrupt mode.

Set the **`int_mode`** parameter to 1 to force using the legacy INTx mode on all NetXtreme II adapters in the system.

```
insmod bnx2x.ko int_mode=1
```

or

```
modprobe bnx2x int_mode=1
```

Set the **`int_mode`** parameter to 2 to force using MSI mode on all NetXtreme II adapters in the system.

```
insmod bnx2x.ko int_mode=2
```

or

```
modprobe bnx2x int_mode=2
```

Set the **`int_mode`** parameter to 3 to force using MSI-X mode on all NetXtreme II adapters in the system.

`droplless_fc`

The **`droplless_fc`** parameter can be used to enable a complementary flow control mechanism on BCM57711/BCM57712 adapters. The default flow control mechanism is to send pause frames when the on-chip buffer (BRB) is reaching a certain level of occupancy. This is a performance targeted flow control mechanism. On BCM57711/BCM57712 adapters, one can enable another flow control mechanism to send pause frames, where one of the host buffers (when in RSS mode) are exhausted.

This is a "zero packet drop" targeted flow control mechanism.

Set the **`droplless_fc`** parameter to 1 to enable the droplless flow control mechanism feature on all BCM57711/BCM57712 NetXtreme II adapters in the system.

```
insmod bnx2x.ko droplless_fc=1
```

or

```
modprobe bnx2x droplless_fc=1
```

`disable_iscsi_ooo`

The **`disable_iscsi_ooo`** parameter is to disable the allocation of the iSCSI TCP Out-of-Order (OOO) reception resources, specifically for VMware for low-memory systems.

`multi_mode`

The optional parameter **`multi_mode`** is for use on systems that support multi-queue networking. Multi-queue networking on the receive side depends only on MSI-X capability of the system, multi-queue networking on the transmit side is supported only on kernels starting from 2.6.27. By default, **`multi_mode`** parameter is set to 1. Thus, on kernels up to 2.6.26, the driver will allocate on the receive side one queue per-CPU and on the transmit side only one queue. On kernels starting from 2.6.27, the driver will allocate on both receive and transmit sides, one queue per-CPU. In any case, the number of allocated queues will be limited by number of queues supported by hardware.

The **`multi_mode`** optional parameter can also be used to enable SAFC (Service Aware Flow Control) by differentiating the traffic to up to 3 CoS (Class of Service) in the hardware according to the VLAN PRI value or according to the IP DSCP value (least 3 bits).

`num_queues`

The optional parameter **`num_queues`** may be used to set the number of queues when **`multi_mode`** is set to 1 and interrupt

mode is MSI-X. If interrupt mode is different than MSI-X (see **int_mode**), the number of queues will be set to 1, discarding the value of this parameter.

pri_map

The optional parameter **pri_map** is used to map the VLAN PRI value or the IP DSCP value to a different or same CoS in the hardware. This 32-bit parameter is evaluated by the driver as an 8 value of 4 bits each. Each nibble sets the desired hardware queue number for that priority. For example, set **pri_map** to 0x11110000 to map priority 0 to 3 to CoS 0 and map priority 4 to 7 to CoS 1.

qs_per_cos

The optional parameter **qs_per_cos** is used to specify how many queues will share the same CoS. This parameter is evaluated by the driver up to 3 values of 8 bits each. Each byte sets the desired number of queues for that CoS. The total number of queues is limited by the hardware limit. For example, set **qs_per_cos** to 0x10101 to create a total of three queues, one per CoS. In another example, set **qs_per_cos** to 0x404 to create a total of 8 queues, divided into 2 CoS, 4 queues in each CoS.

cos_min_rate

The optional parameter **cos_min_rate** is used to determine the weight of each CoS for round-robin scheduling in transmission. This parameter is evaluated by the driver as up to 3 values of 8 bits each. Each byte sets the desired weight for that CoS. The weight ranges from 0 to 100. For example, set **cos_min_rate** to 0x101 for fair transmission rate between 2 CoS. In another example, set the **cos_min_rate** to 0x30201 to give CoS the higher rate of transmission. To avoid using the fairness algorithm, omit setting **cos_min_rate** or set it to 0.

Set the **multi_mode** parameter to 2 as shown below to differentiate the traffic according to the VLAN PRI value.

```
insmod bnx2x.ko multi_mode=2 pri_map=0x11110000 qs_per_cos=0x404
```

or

```
modprobe bnx2x multi_mode=2 pri_map=0x11110000 qs_per_cos=0x404
```

Set the **multi_mode** parameter to 4 as shown below to differentiate the traffic according to the IP DSCP value.

```
insmod bnx2x.ko multi_mode=4 pri_map=0x22221100 qs_per_cos=0x10101 cos_min_rate=0x30201
```

or

```
modprobe bnx2x multi_mode=4 pri_map=0x22221100 qs_per_cos=0x10101 cos_min_rate=0x30201
```

bnx2i Driver

Optional parameters **en_tcp_dack**, **error_mask1**, and **error_mask2** can be supplied as command line arguments to the `insmod` or `modprobe` command for `bnx2i`.

error_mask1 and **error_mask2**

"Config FW iSCSI Error Mask #", use to configure certain iSCSI protocol violation to be treated either as a warning or a fatal error. All fatal iSCSI protocol violations will result in session recovery (ERL 0). These are bit masks.

Defaults: All violations will be treated as errors.

 **CAUTION!** Do not use **error_mask** if you are not sure about the consequences. These values are to be discussed with Broadcom development team on a case-by-case basis. This is just a mechanism to work around iSCSI implementation issues on the target side and without proper knowledge of iSCSI protocol details, users are advised not to experiment with these parameters.

en_tcp_dack

"Enable TCP Delayed ACK", enables/disables TCP delayed ACK feature on offloaded iSCSI connections.

Defaults: TCP delayed ACK is ENABLED. For example:

```
insmod bnx2i.ko en_tcp_dack=0
```

or

```
modprobe bnx2i en_tcp_dack=0
```

time_stamps

"Enable TCP TimeStamps", enables/disables TCP time stamp feature on offloaded iSCSI connections.

Defaults: TCP time stamp option is DISABLED. For example:

```
insmod bnx2i.ko time_stamps=1
```

or

```
modprobe bnx2i time_stamps=1
```

sq_size

"Configure SQ size", used to choose send queue size for offloaded connections and SQ size determines the maximum SCSI commands that can be queued. SQ size also has a bearing on the number of connections that can be offloaded; as QP size increases, the number of connections supported will decrease. With the default values, the BCM5708 adapter can offload 28 connections.

Defaults: 128

Range: 32 to 128

Note that Broadcom validation is limited to a power of 2; for example, 32, 64, 128.

rq_size

"Configure RQ size", used to choose the size of asynchronous buffer queue size per offloaded connections. RQ size is not required greater than 16 as it is used to place iSCSI ASYNC/NOP/REJECT messages and SCSI sense data.

Defaults: 16

Range: 16 to 32

Note that Broadcom validation is limited to a power of 2; for example, 16, 32.

event_coal_div

"Event Coalescing Divide Factor", performance tuning parameter used to moderate the rate of interrupt generation by the iscsi firmware.

Defaults: 1

Valid values: 1, 2, 4, 8

last_active_tcp_port

"Last active TCP port used", status parameter used to indicate the last TCP port number used in the iSCSI offload connection.

Defaults: N/A

Valid values: N/A

Note: This is a read-only parameter.

ooo_enable

"Enable TCP out-of-order feature", enables/disables TCP out-of-order rx handling feature on offloaded iSCSI connections.

Defaults: TCP out-of-order feature is ENABLED. For example:

```
insmod bnx2i.ko ooo_enable=1
```

or

```
modprobe bnx2i ooo_enable=1
```

Driver Defaults

- [bnx2 Driver](#)
- [bnx2x Driver](#)

bnx2 Driver

Speed: Autonegotiation with all speeds advertised

Flow Control: Autonegotiation with RX and TX advertised

MTU: 1500 (range is 46–9000)

RX Ring Size: 255 (range is 0–4080)

RX Jumbo Ring Size: 0 (range 0–16320) adjusted by the driver based on MTU and RX Ring Size

TX Ring Size: 255 (range is (MAX_SKB_FRAGS+1)–255). MAX_SKB_FRAGS varies on different kernels and different architectures. On a 2.6 kernel for x86, MAX_SKB_FRAGS is 18.

Coalesce RX Microseconds: 18 (range is 0–1023)

Coalesce RX Microseconds IRQ: 18 (range is 0–1023)

Coalesce RX Frames: 6 (range is 0–255)

Coalesce RX Frames IRQ: 6 (range is 0–255)

Coalesce TX Microseconds: 80 (range is 0–1023)

Coalesce TX Microseconds IRQ: 80 (range is 0–1023)

Coalesce TX Frames: 20 (range is 0–255)

Coalesce TX Frames IRQ: 20 (range is 0–255)

Coalesce Statistics Microseconds: 999936 (approximately 1 second) (range is 0–16776960 in increments of 256)

MSI: Enabled (if supported by the 2.6 kernel and the interrupt test passes)

TSO: Enabled (on 2.6 kernels)

WoL: Initial setting based on NVRAM's setting

bnx2x Driver

Speed: Autonegotiation with all speeds advertised

Flow control: Autonegotiation with RX and TX advertised

MTU: 1500 (range is 46–9000)

RX Ring Size: 4078 (range is 0–4078)

TX Ring Size: 4078 (range is (MAX_SKB_FRAGS+4)–4078). MAX_SKB_FRAGS varies on different kernels and different architectures. On a 2.6 kernel for x86, MAX_SKB_FRAGS is 18.

Coalesce RX Microseconds: 25 (range is 0–3000)

Coalesce TX Microseconds: 50 (range is 0–12288)

Coalesce Statistics Microseconds: 999936 (approximately 1 second) (range is 0–16776960 in increments of 256)

MSI -X: Enabled (if supported by the 2.6 kernel and the interrupt test passes)

TSO: Enabled

WoL: Disabled

Driver Messages

The following are the most common sample messages that may be logged in the /var/log/messages file. Use dmesg -n

<level> to control the level at which messages appear on the console. Most systems are set to level 6 by default. To see all messages, set the level higher.

- [bnx2 and bnx2x Driver](#)
- [bnx2i Driver](#)

bnx2 and bnx2x Driver

 NOTE: The examples used in this procedure refer to the bnx2 driver, but also apply to the bnx2x driver.

Driver Sign on

```
Broadcom NetXtreme II Gigabit Ethernet Driver
bnx2 v1.6.3c (July 23, 2007)
```

CNIC Driver Sign on (bnx2 only)

```
Broadcom NetXtreme II cnic v1.1.19 (Sep 25, 2007)
```

NIC Detected

```
eth#: Broadcom NetXtreme II BCM5708 1000Base-T (B0)
PCI-X 64-bit 133MHz found at mem f6000000, IRQ 16, node addr 0010180476ae
cnic: Added CNIC device: eth0
```

Link Up and Speed Indication

```
bnx2: eth# NIC Link is Up, 1000 Mbps full duplex
```

Link Down Indication

```
bnx2: eth# NIC Link is Down
```

MSI enabled successfully (bnx2 only)

```
bnx2: eth0: using MSI
```

MSI-X enabled successfully (bnx2x only)

```
bnx2x: eth0: using MSI-X
```

bnx2i Driver

BNX2I Driver signon

```
Broadcom NetXtreme II iSCSI Driver bnx2i v2.1.1D (May 12, 2010)
```

Network port to iSCSI transport name binding

```
bnx2i: netif=eth2, iscsi=bcm570x-050000
bnx2i: netif=eth1, iscsi=bcm570x-030c00
```

Driver completes handshake with iSCSI offload-enabled CNIC device

```
bnx2i [05:00.00]: ISCSI_INIT passed
```

 NOTE: This message is displayed only when the user attempts to make an iSCSI connection.

Driver detects iSCSI offload is not enabled on the CNIC device

```
bnx2i: iSCSI not supported, dev=eth3
bnx2i: bnx2i: LOM is not enabled to offload iSCSI connections, dev=eth0
bnx2i: dev eth0 does not support iSCSI
```

Exceeds maximum allowed iSCSI connection offload limit

```
bnx2i: alloc_ep: unable to allocate iscsi cid
bnx2i: unable to allocate iSCSI context resources
```

Network route to target node and transport name binding are two different devices

```
bnx2i: conn bind, ep=0x... ($ROUTE_HBA) does not belong to hba $USER_CHOSEN_HBA
```

where ROUTE_HBA --> net device on which connection was offloaded based on route information USER_CHOSEN_HBA --> HBA to which target node is bound (using iscsi transport name)

Target cannot be reached on any of the CNIC devices

```
bnx2i: check route, cannot connect using cnic
```

Network route is assigned to network interface, which is down

```
bnx2i: check route, hba not found
```

Attempting to offload iSCSI connection onto a Jumbo Frame-enabled device

```
bnx2i: eth# network i/f mtu is set to #mtu
bnx2i: iSCSI HBA can support mtu of 1500
```

 **NOTE:** Change **mtu** to **1500** using ifconfig and restart the interface in order to offload iSCSI connections.

SCSI-ML initiated host reset (session recovery)

```
bnx2i: attempting to reset host, #3
```

CNIC detects iSCSI protocol violation - Fatal errors

```
bnx2i: iscsi_error - wrong StatSN rcvd
bnx2i: iscsi_error - hdr digest err
bnx2i: iscsi_error - data digest err
bnx2i: iscsi_error - wrong opcode rcvd
bnx2i: iscsi_error - AHS len > 0 rcvd
bnx2i: iscsi_error - invalid ITT rcvd
bnx2i: iscsi_error - wrong StatSN rcvd
bnx2i: iscsi_error - wrong DataSN rcvd
bnx2i: iscsi_error - pend R2T violation
bnx2i: iscsi_error - ERL0, U0
bnx2i: iscsi_error - ERL0, U1
bnx2i: iscsi_error - ERL0, U2
bnx2i: iscsi_error - ERL0, U3
bnx2i: iscsi_error - ERL0, U4
bnx2i: iscsi_error - ERL0, U5
bnx2i: iscsi_error - ERL0, U
bnx2i: iscsi_error - invalid resi len
bnx2i: iscsi_error - MRDSL violation
bnx2i: iscsi_error - F-bit not set
bnx2i: iscsi_error - invalid TTT
bnx2i: iscsi_error - invalid DataSN
bnx2i: iscsi_error - burst len violation
bnx2i: iscsi_error - buf offset violation
bnx2i: iscsi_error - invalid LUN field
bnx2i: iscsi_error - invalid R2TSN field
bnx2i: iscsi_error - invalid cmd len1
bnx2i: iscsi_error - invalid cmd len2
bnx2i: iscsi_error - pend r2t exceeds MaxOutstandingR2T value
bnx2i: iscsi_error - TTT is rsvd
bnx2i: iscsi_error - MBL violation
bnx2i: iscsi_error - data seg len != 0
bnx2i: iscsi_error - reject pdu len error
bnx2i: iscsi_error - async pdu len error
bnx2i: iscsi_error - nopin pdu len error
bnx2i: iscsi_error - pend r2t in cleanup
bnx2i: iscsi_error - IP fragments rcvd
bnx2i: iscsi_error - IP options error
bnx2i: iscsi_error - urgent flag error
```

CNIC detects iSCSI protocol violation - non-FATAL, warning

```
bnx2i: iscsi_warning - invalid TTT
bnx2i: iscsi_warning - invalid DataSN
bnx2i: iscsi_warning - invalid LUN field
```

 **NOTE:** The driver needs to be configured to consider certain violation to treat as warning and not as a critical error.

Driver puts a session through recovery

```
conn_err - hostno 3 conn 03fbcd00, iscsi_cid 2 cid a1800
```

Reject iSCSI PDU received from the target

```
bnx2i - printing rejected PDU contents
[0]: 1 ffffffffal 0 0 0 0 20 0
[8]: 0 7 0 0 0 0 0 0
[10]: 0 0 40 24 0 0 ffffffff80 0
[18]: 0 0 3 ffffffff88 0 0 3 4b
[20]: 2a 0 0 2 ffffffff8c 14 0 0
[28]: 40 0 0 0 0 0 0 0
```

Open-iSCSI daemon handing over session to driver

```
bnx2i: conn update - MBL 0x800 FBL 0x800MRDSL_I 0x800 MRDSL_T 0x2000
```

Teaming with Channel Bonding

With the Linux drivers, you can team adapters together using the bonding kernel module and a channel bonding interface. For more information, see the Channel Bonding information in your operating system documentation.

Remote PHY Support

The bnx2 driver supports Remote PHY on blade servers that use the NetXtreme II BCM5708S or BCM5709S device, support Remote PHY, and have Remote PHY enabled.

On Remote PHY-enabled systems, the bnx2 driver enables the NetXtreme II BCM5708S or BCM5709S device to take advantage of the features available in the blade chassis' copper twisted pair PHY. The bnx2 driver will indicate that it is using Remote PHY twisted pair mode in ethtool output.

 NOTE: bnx2 driver versions prior to 1.63d do not support Remote PHY and operating systems using these older drivers may behave differently than operating systems with Remote PHY driver support. Refer to your system and operating system documentation for the status of Remote PHY support.

Configure the adapter using the standard ethtool commands.

Statistics

Detailed statistics and configuration information can be viewed using the ethtool utility. See the ethtool man page for more information.

Linux iSCSI Offload

- [Open iSCSI User Applications](#)
- [User Application - brcm_iscsiuio](#)
- [Bind iSCSI Target to Broadcom NX2 iSCSI Transport Name](#)
- [VLAN Configuration for iSCSI Offload \(Linux\)](#)
- [Making Connections to iSCSI Targets](#)
- [Maximum Offload iSCSI Connections](#)
- [Linux iSCSI Offload FAQ](#)

Open iSCSI User Applications

Install and run the inbox open-iscsi initiator programs from the DVD. Refer to [Packaging](#) for details.

User Application - brcm_iscsiuio

Install and run the brcm_iscsiuio daemon before attempting to create iSCSI connections. The driver will not be able to establish connections to the iSCSI target without the daemon's assistance.

1. Install the brcm_iscsiuio source package

```
# tar -xvzf iscsiuiio-<version>.tar.gz
```
2. CD to the directory where iscsiuiio is extracted

```
# cd iscsiuiio-<version>
```
3. Compile and install

```
# ./configure
# make
# make install
```
4. Check the iscsiuiio version matches with the source package

```
# brcm_iscsiuio -v
```
5. Start brcm_iscsiuio

```
# brcm_iscsiuio
```

Bind iSCSI Target to Broadcom NX2 iSCSI Transport Name

By default, the open-iscsi daemon connects to discovered targets using software initiator (transport name = 'tcp'). Users who wish to offload iSCSI connection onto CNIC device should explicitly change transport binding of the iSCSI iface. This can be done using the **iscsiadm** CLI utility as follows,

```
iscsiadm -m iface -I <iface_file_name> -n iface.transport_name -v bnx2i -o update
```

where the iface file includes the following information for RHEL 5.4, RHEL 5.5, and SLES 11 SP1:

```
iface.net_ifacename = ethX
iface.iscsi_ifacename = <name of the iface file>
iface.hwaddress = XX:XX:XX:XX:XX:XX
iface.ipaddress = XX.XX.XX.XX
iface.transport_name = bnx2i
```

Ensure that the iface.hwaddress is in lower case format.

If you wish to switch back to use the software initiator, use the following:

```
iscsiadm -m iface -I <iface_file_name> -n iface.transport_name -v tcp -o update
```

where the iface file includes the following information:

```
iface.net_ifacename = ethX
iface.iscsi_ifacename = <name of the iface file>
iface.transport_name = tcp
```

VLAN Configuration for iSCSI Offload (Linux)

iSCSI traffic on the network may be isolated in a VLAN to segregate it from other traffic. When this is the case, you must make the iSCSI interface on the adapter a member of that VLAN.

Modifying the iSCSI iface File

To configure the iSCSI VLAN add the VLAN ID in the iface file for iSCSI. In the following example, the VLAN ID is set to 100.

```
#Begin Record 6.2.0-873.2.el6
Iface.iscsi_ifacefile name = <>
Iface.ipaddress = 0.0.0.0
Iface.hwaddress = <>
Iface.trasport_name = bnx2i
Iface.vlan_id = 100
Iface.vlan_priority = 0
Iface.iface_num = 100
Iface.mtu = 0
Iface.port = 0
#END Record
```

 **NOTE:** Although not strictly required, Broadcom recommends configuring the same VLAN ID on the iface.iface_num field for iface file identification purposes.

Setting the VLAN ID on the Ethernet Interface

If using RHEL5.X versions of Linux, it is recommended that you configure the iSCSI VLAN on the Ethernet interface. **In RHEL6.3, and sles11sp3, it is not necessary to set the VLAN on the Ethernet driver.**

Execute the following commands to set the VLAN ID:

```
vconfig add ethx <vlan number> — Creates an L2 VLAN interface.
```

```
Ifconfig eth.<VLANID> <static ip> up — Assigns and IP address to the VLAN interface.
```

Use the following command to get detailed information about VLAN interface:

```
# cat /proc/net/vlan/ethx.<vlanid>
```

Preserve the VLAN configuration across reboots by adding it to configuration files. Configure the VLAN interface configuration in /etc/sysconfig/network-scripts. The configuration filename has a specific format that includes the physical interface, a character, and the VLAN ID.

For example, if the VLAN ID is 100, and the physical interface is eth0, then the configuration filename should be *ifcfg-eth0.100*. The following are example settings in the configuration file.

```
"DEVICE=ethX.100
"BOOTPROTO=static
```

```
"ONBOOT=yes
"IPADDR=<>
"NETMASK=<>
"USERCTL=no
"NETWORK=<>
"VLAN=yes
```

Restart the networking service, in order for the changes to take effect, as follows:

```
"Service network restart"
```

Making Connections to iSCSI Targets

Refer to open-iscsi documentation for a comprehensive list of **iscsiadm** commands. This is a sample list of commands to discovery targets and to create iscsi connections to a target.

Add static entry

```
iscsiadm -m node -p <ipaddr[:port]> -T iqn.2007-05.com.broadcom:target1 -o new -I <iface_file_name>
```

iSCSI target discovery using 'SendTargets'

```
iscsiadm -m discovery --type sendtargets -p <ipaddr[:port]> -I <iface_file_name>
```

Login to target using 'iscsiadm' command

```
iscsiadm --mode node --targetname <iqn.targetname> --portal <ipaddr[:port]> --login
```

List all drives active in the system

```
fdisk -l
```

Maximum Offload iSCSI Connections

With default driver parameters set, which includes 128 outstanding commands, bnx2i can offload the following number of connections:

```
BCM5708: 28
BCM5709: 43
BCM5771x: 128
```

This is not a hard limit, but just a simple on-chip resource allocation math. bnx2i will be able to offload > 28 connections on 1G devices by reducing the shared queue size, which in turn limits the maximum outstanding tasks on a connection. See [Setting Values for Optional Properties](#) for information on sq_size and rq_size. The driver logs the following message to syslog when the maximum allowed connection offload limit is reached - "bnx2i: unable to allocate iSCSI context resources".

Linux iSCSI Offload FAQ

- Not all Broadcom NetXtreme II adapters support iSCSI offload.
- The iSCSI session will not recover after a hot remove and hot plug.
- For MPIO to work properly, iSCSI nopout should be enabled on each iSCSI session. Refer to open-iscsi documentation for procedures on setting up **noop_out_interval** and **noop_out_timeout** values.
- In the scenario where multiple CNIC devices are in the system and the system is booted via Broadcom's iSCSI boot solution, ensure that the iscsi node under /etc/iscsi/nodes for the boot target is bound to the NIC that is used for booting.

Please read all [Restrictions and Disclaimers](#).

[Back to Contents Page](#)

[Back to Contents Page](#)

Solaris Driver Software: Broadcom NetXtreme II® Network Adapter User Guide

- [Overview](#)
- [Installing the Driver](#)
- [Upgrading the Driver](#)
- [Uninstalling Driver](#)
- [Configuring the Driver](#)
- [Memory Usage](#)
- [Interrupt Management](#)
- [FCoE Support](#)

Overview

This file describes how to install the Solaris driver for Broadcom's NetXtreme II 10 Gigabit Ethernet network adapters. Refer to the 'bnxe' manual page for details on how to configure the driver.

The Solaris driver is released in two formats:

- `BRCMbnxe-version.pkg`: Datastream format
- `BRCMbnxe-version.tar.Z`: Compressed TAR file system format.

 NOTE: A DU image does not exist at this time because of driver size limitations. Solaris DU diskettes can be used to install the driver into the system both during system installation and/or after the system has been installed and booted.

This driver only works with the GLDv3 Streams interface as it appears in Solaris 10 (Update 4) and later.

Installing the Driver

1. Change directory to where `BRCMbnxe-version.pkg` resides.
2. `pkgadd -d BRCMbnxe-version.pkg`

or

1. Copy `BRCMbnxe-X.Y.Z.tar.Z` to `/tmp`.
2. `cd /tmp`

```
uncompress BRCMbnxe-version.tar.Z
tar -xvf BRCMbnxe-version.tar
pkgadd -d /tmp
```
3. Execute `prtconf` to determine instance numbers of the NIC.
4. `ifconfig bnxe[instance_number] plumb`
5. `ifconfig bnxe[instance_number] ip_address netmask up`

To make these changes permanent:

1. Use your favorite text editor and create a file named `hostname.bnxe[instance_number]` in the `/etc` directory. Add the IP address of the interface to this file, save, and exit.
2. Add a proper subnet mask to the file `/etc/netmasks`.

Upgrading the Driver

To upgrade the Broadcom driver package to the current version, you must first uninstall the previous driver version from the system. See [Uninstalling Driver](#). Once the previous driver has been removed, you can follow any of the installation methods in this document to install the new driver version.

 NOTE: Do not install multiple instances of the driver on a single system.

Uninstalling Driver

1. `ifconfig bnxe[instance_number] down`
2. `ifconfig bnxe[instance_number] unplumb`
3. `pkgrm BRCMbnxe`

Configuring the Driver

The `bnxe` driver can be configured via the `bnxe.conf` file installed under `/kernel/drv`. When this config file is modified, the system must be either rebooted or the driver unloaded and reconfigured using the `update_drv` admin command.

All configuration can be specified per-instance. The format used is as follows and each line must end with a semicolon:

```
bnxe<#>_<config_item>=X;
```

So for `adv_autoneg_cap`, you would use the following:

```
bnxe0_adv_autoneg_cap=1;
bnxe1_adv_autoneg_cap=0;
bnxe2_adv_autoneg_cap=1;
bnxe3_adv_autoneg_cap=1;
```

If a configuration item is not specified for a specific instance, then the default value will be used. The default value used by all instances can be overridden using:

```
default_<config_item>=X;
```

For boolean values, 1 = TRUE and 0 = FALSE.

Memory Usage

The number of RX/TX buffer descriptors specified in the configuration file can have a detrimental affect on memory usage. If the counts are too high, DMA allocations can fail, thereby affecting other drivers loaded on the system. If DMA allocations fail during system initialization and/or boot, then there is a chance the system will not boot. This behavior is an implementation constraint of the Solaris OS. Additionally, it has been seen that the amount of DMA allocation space available on a system running in 32-bit mode is less than when running as 64-bit.

For a single RX descriptor, the following is allocated:

- 1 DMA handle
- 1 DMA memory buffer that is MTU in size
- 1K memory overhead

For a single TX descriptor, the following is allocated:

- 9 DMA handles for sending chained mblks
- 1 DMA memory buffer that is MTU in size
- 1K memory overhead

 NOTE: The number of DMA handles available in the system scales with the amount of RAM. With more RAM, the descriptor counts can be safely increased.

The default number of RX/TX buffer descriptors is 2048 for each. When using a Broadcom BCM57711 network adapter in multifunction mode, the number of configured descriptors is divided by four, ending up at 512. This is to keep the number of DMA allocations at a minimum. After installation, it is suggested these descriptor counts be increased until stability is guaranteed and the desired performance is reached.

For example, using the default setting of 2048 for the number of both RX and TX descriptors, the approximate amount of

memory a single interface would consume is:

Single Function Mode

- RX: 2048 DMA handles and 5M (MTU=1500) or 21M (MTU=9216) of memory
- TX: 20480 DMA handles and 5M (MTU=1500) or 21M (MTU=9216) of memory
- Total: 22528 DMA handles and 10M (MTU=1500) or 42M (MTU=9216) of memory

Multifunction Mode (#descs / 4)

- RX: 512 DMA handles and 1M (MTU=1500) or 5M (MTU=9216) of memory
- TX: 5120 DMA handles and 1M (MTU=1500) or 5M (MTU=9216) of memory
- Total: 5335 DMA handles and 2M (MTU=1500) or 10M (MTU=9216) of memory

Interrupt Management

If you have a system with many interfaces, it is possible to reach the allocation limit of MSIX interrupts. By default, Solaris limits each driver to 2 MSIX allocations, and there is an issue with the pcplusmp module where only a maximum of 31 MSIX interrupts are available per interrupt priority level.

If your system has four Broadcom BCM57711 network adapter ports, each running in multifunction mode, Solaris will enumerate 16 bnx interfaces. The last interface attached will fail to allocate its second MSIX interrupt and revert to Fixed. This in turn can eventually expose an issue in the system regarding interrupt management resulting in interrupts never being received on the interface that reverted back to Fixed.

To ensure all interfaces are able to allocate their two MSIX interrupts, the workaround is to change the priority levels of specific interfaces. Network drivers are automatically assigned an interrupt priority level of 6, so changing an interface's priority level to 5 is common.

1. First read the driver.conf man page for a background primer.
2. Find out the driver instance paths assigned on your system.

```
% grep bnx /etc/path_to_inst
"/pci@0,0/pci8086,2779@1/pci14e4,1650@0" 0 "bnxe"
"/pci@0,0/pci8086,2779@1/pci14e4,1650@0,1" 1 "bnxe"
```

3. Normally, the name of the driver is the last portion of the path, but you should use the most appropriate PCI ID found in /etc/driver_aliases. Depending on how the hardware is layered, there are cases where the name identified in path_to_inst will not work. To figure out which name to use, examine the output from **prtconf -v** and match against the IDs specified in the driver_aliases file.

```
% grep bnx /etc/driver_aliases
bnxe "pci14e4,164e"
bnxe "pci14e4,164f"
bnxe "pci14e4,1650"
bnxe "pciex14e4,164e"
bnxe "pciex14e4,164f"
bnxe "pciex14e4,1650"
```

4. The parent of the driver is the entire path leading up to the name.
5. The unit-address is located after the final @ in the path.
6. Therefore, change both of the bnx interfaces found in path_to_inst to interrupt priority 5 and use the following config lines to bnx.conf:

```
name = "pciex14e4,1650" parent = "/pci@0,0/pci8086,2779@1" unit-address = "0" interrupt-priorities =
5;
name = "pciex14e4,1650" parent = "/pci@0,0/pci8086,2779@1" unit-address = "0,1" interrupt-priorities
= 5;
```

7. After modifying the config, either reboot the system or unplumb all interfaces and run the update_drv command.
8. When the system has been reconfigured and the interfaces plumbed back up, verify the new interrupt priority settings by running the following command as root:

```
% echo "::interrupts -d" | mdb -k
```

FCoE Support

Overview

FCoE is supported on Solaris 11 with limited support on Solaris 10, Update 9. The following features are the differences in Solaris 10, Update 9 when compared to Solaris 11:

- Support does not exist for NPIV in the Solaris 10 Update 9.
- Some of the fcinfo(1M) options, which are available in Solaris 11, are not be available in Solaris 10, Update 9. For more information, read the man page fcinfo(1M).
- brcmfcoeadm(1M) feature is supported in both Solaris 10 Update 9 and Solaris 11. However, when "delete-fcoe-port" is complete, you need to issue the following two commands to unload the bnxef driver before you can re-issue "create-fcoe-port". There is a reaper thread in Solaris 11 that aggressively looks for unused driver modules and unloads the driver. That thread does not exist in Solaris 10 Update 9. Therefore, you have to explicitly look for the driver module ID of the bnxef driver by issuing the following command.

```
# modinfo | grep bnxef
249 ffffffff8d63000 486b8 54 1 bnxef (6.4.13)
```

Then issue the modunload command to unload the module before "create-fcoe-port" is issued to create a new FCoE port.

```
# modunload -i 249
```

Any time "create-fcoe-port" needs to be issued, the driver must be unloaded, if it is already loaded. If not, the "create-fcoe-port" will fail indicating the driver is busy. This is true when you have two or more instances of bnxef loaded, in which case, you should first delete all FCoE ports and then unload the driver. Unloading will occur only when all the instances are deleted.

Supported FC/FCoE Devices

The bnxef Broadcom 10 Gb FCoE driver works with all the major FCoE fabric devices. It is also compatible with all known FC disk devices and tape devices working through the FCoE fabric.

Unloading FCoE Driver

Delete all FCoE ports created across the various bnxef instances.

1. Delete all the NPIV ports created before deleting FCoE ports.
2. brcmfcoeadm delete-fcoe-port bnxef<instance_number>
3. modinfo | grep bnxef

The first column for the above command will give the module ID for the bnxef driver.

4. modunload -i <module id>

The procedure should unload the driver. However, if there are many instances of the FCoE ports created, all the FCoE ports must be deleted before the unload can be attempted.

Configuring the FCoE Driver

The bnxef driver can be configured via the bnxef.conf file installed under /kernel/drv. When this config file is modified, the system must be either rebooted or use the update_drv(1M) command to update the driver configuration.

The details of the configurations parameters are detailed in the bnxef(7D) man page. The default parameters should work for all conditions.

Please read all [Restrictions and Disclaimers](#).

[Back to Contents Page](#)

[Back to Contents Page](#)

VMware Driver Software: Broadcom NetXtreme II® Network Adapter User Guide

- Packaging
- Networking Support
- Drivers
- FCoE Support

Packaging

The VMware driver is released in the packaging formats shown in [Table 1](#).

Table 1: VMware Driver Packaging

Format	Drivers
Compressed tar	<code>bnx2x-version.tar.gz</code>
VMware VIB	<code>vmware-esx-drivers-net-bnx2x-version.x86_64.vib</code>

Networking Support

This section describes the bnx2x VMware ESX driver for the Broadcom NetXtreme II PCIE 10 GbE network adapters.

Drivers

Download, Install, and Update Drivers

To download, install, or update the VMware ESX/ESXi driver for NetXtreme II 10 GbE network adapters, see <http://www.vmware.com/support>.

Driver Parameters

Several optional parameters can be supplied as a command line argument to the `vmkload_mod` command. These parameters can also be set via the `esxcfg-module` command. See the man page for more information.

`int_mode`

The optional parameter **int_mode** is used to force using an interrupt mode other than MSI-X. By default, the driver will try to enable MSI-X if it is supported by the kernel. If MSI-X is not attainable, then the driver will try to enable MSI if it is supported by the kernel. If MSI is not attainable, then the driver will use the legacy INTx mode.

Set the **int_mode** parameter to 1 as shown below to force using the legacy INTx mode on all NetXtreme II network adapters in the system.

```
vmkload_mod bnx2x int_mode=1
```

Set the **int_mode** parameter to 2 as shown below to force using MSI mode on all NetXtreme II network adapters in the system.

```
vmkload_mod bnx2x int_mode=2
```

`disable_tpa`

The optional parameter **disable_tpa** can be used to disable the Transparent Packet Aggregation (TPA) feature. By default, the driver will aggregate TCP packets, but if you would like to disable this advanced feature, it can be done.

Set the **disable_tpa** parameter to 1 as shown below to disable the TPA feature on all NetXtreme II network adapters in the system.

```
vmkload_mod bnx2x.ko disable_tpa=1
```

Use `ethtool` to disable TPA (LRO) for a specific network adapter.

`num_rx_queues`

The optional parameter **num_rx_queues** may be used to set the number of Rx queues on kernels starting from 2.6.24 when **multi_mode** is set to 1 and interrupt mode is MSI-X. Number of Rx queues must be equal to or greater than the number of Tx queues (see **num_tx_queues** parameter). If the interrupt mode is different than MSI-X (see **int_mode** parameter), then the number of Rx queues will be set to 1, discarding the value of this parameter.

`num_tx_queues`

The optional parameter **num_tx_queues** may be used to set the number of Tx queues on kernels starting from 2.6.27 when **multi_mode** is set to 1 and interrupt mode is MSI-X. The number of Rx queues must be equal to or greater than the number of Tx queues (see **num_rx_queues** parameter). If the interrupt mode is different than MSI-X (see **int_mode** parameter), then the number of Tx queues will be set to 1, discarding the value of this parameter.

`pri_map`

The optional parameter **pri_map** is used to map the VLAN PRI value or the IP DSCP value to a different or the same CoS in the hardware. This 32-bit parameter is evaluated by the driver as 8 values of 4 bits each. Each nibble sets the desired hardware queue number for that priority.

For example, set the **pri_map** parameter to `0x22221100` to map priority 0 and 1 to CoS 0, map priority 2 and 3 to CoS 1, and map priority 4 to 7 to CoS 2. In another example, set the **pri_map** parameter to `0x11110000` to map priority 0 to 3 to CoS 0, and map priority 4 to 7 to CoS 1.

`qs_per_cos`

The optional parameter **qs_per_cos** is used to specify the number of queues that will share the same CoS. This parameter is evaluated by the driver up to 3 values of 8 bits each. Each byte sets the desired number of queues for that CoS. The total number of queues is limited by the hardware limit.

For example, set the **qs_per_cos** parameter to 0x10101 to create a total of three queues, one per CoS. In another example, set the **qs_per_cos** parameter to 0x404 to create a total of 8 queues, divided into only 2 CoS, 4 queues in each CoS.

cos_min_rate

The optional parameter **cos_min_rate** is used to determine the weight of each CoS for Round-robin scheduling in transmission. This parameter is evaluated by the driver up to 3 values of 8 bits each. Each byte sets the desired weight for that CoS. The weight ranges from 0 to 100.

For example, set the **cos_min_rate** parameter to 0x101 for fair transmission rate between two CoS. In another example, set the **cos_min_rate** parameter to 0x30201 to give the higher CoS the higher rate of transmission. To avoid using the fairness algorithm, omit setting the optional parameter **cos_min_rate** or set it to 0.

dropless_fc

The optional parameter **dropless_fc** can be used to enable a complementary flow control mechanism on Broadcom network adapters. The default flow control mechanism is to send pause frames when the on-chip buffer (BRB) is reaching a certain level of occupancy. This is a performance targeted flow control mechanism. On Broadcom network adapters, you can enable another flow control mechanism to send pause frames if one of the host buffers (when in RSS mode) is exhausted. This is a "zero packet drop" targeted flow control mechanism.

Set the **dropless_fc** parameter to 1 as shown below to enable the dropless flow control mechanism feature on all Broadcom network adapters in the system.

```
vmkload_mod bnx2x dropless_fc=1
```

Driver Defaults

Speed: Autonegotiation with all speeds advertised

Flow Control: Autonegotiation with rx and tx advertised

MTU: 1500 (range 46–9000)

Rx Ring Size: 4078 (range 0–4078)

Tx Ring Size: 4078 (range (MAX_SKB_FRAGS+4) - 4078). MAX_SKB_FRAGS varies on different kernels and different architectures. On a 2.6 kernel for x86, MAX_SKB_FRAGS is 18.

Coalesce RX Microseconds: 25 (range 0–3000)

Coalesce TX Microseconds: 50 (range 0–12288)

MSI-X: Enabled (if supported by 2.6 kernel)

TSO: Enabled

WoL: Disabled

Unloading and Removing Driver

To unload the driver, type the following:

```
vmkload_mod -u bnx2x
```

Driver Messages

The following are the most common sample messages that may be logged in the file /var/log/messages. Use `dmesg -n <level>` to control the level at which messages will appear on the console. Most systems are set to level 6 by default. To see all messages, set the level higher.

Driver Sign On

```
Broadcom NetXtreme II 5771x 10Gigabit Ethernet Driver
bnx2x 0.40.15 ($DateTime: 2007/11/22 05:32:40 $)
```

NIC Detected

```
eth0: Broadcom NetXtreme II BCM57710 XGb (A1)
PCI-E x8 2.5GHz Found at mem e8800000, IRQ 16, node addr 001018360012
```

MSI-X Enabled Successfully

```
bnx2x: eth0: using MSI-X
```

Link Up and Speed Indication

```
bnx2x: eth0 NIC Link is Up, 10000 Mbps full duplex, receive & transmit flow control ON
```

Link Down Indication

```
bnx2x: eth0 NIC Link is Down
```

Memory Limitation

If you see messages in the log file that look like the following, then the ESX host is severely strained. To relieve this, disable NetQueue.

```
Dec 2 18:24:20 ESX4 vmkernel: 0:00:00:32.342 cpu2:4142)WARNING: Heap: 1435: Heap bnx2x already at its maximumSize. Cannot expand.
Dec 2 18:24:20 ESX4 vmkernel: 0:00:00:32.342 cpu2:4142)WARNING: Heap: 1645: Heap_Align(bnx2x, 4096/4096 bytes, 4096 align) failed.
caller: 0x41800187d654
Dec 2 18:24:20 ESX4 vmkernel: 0:00:00:32.342 cpu2:4142)WARNING: vmklinux26: alloc_pages: Out of memory
```

Disable NetQueue by manually loading the bnx2x vmkernel module via the command.

```
vmkload_mod bnx2x multi_mode=0
```

or to persist the settings across reboots via the command

```
esxcfg-module -s multi_mode=0 bnx2x
```

Reboot the machine for the settings to take place.

MultiQueue/NetQueue

The optional parameter **num_queues** may be used to set the number of Rx and Tx queues when **multi_mode** is set to 1 and interrupt mode is MSI-X. If interrupt mode is different than MSI-X (see **int_mode** parameter), the number of Rx and Tx queues will be set to 1, discarding the value of this parameter.

If you would like the use of more than 1 queue, force the number of NetQueues to use via the following command:

```
esxcfg-module -s "multi_mode=1 num_queues=<num of queues>" bnx2x
```

Otherwise, allow the bnx2x driver to select the number of NetQueues to use via the following command:

```
esxcfg-module -s "multi_mode=1 num_queues=0" bnx2x
```

The optimal number is to have the number of NetQueues match the number of CPUs on the machine.

FCoE Support

This section describes the contents and procedures associated with installation of the VMware software package for supporting Broadcom FCoE C-NICs.

Drivers

Table 2: Broadcom NetXtreme II FCoE Drivers

Driver	Description
bnx2x	This driver manages all PCI device resources (registers, host interface queues, etc.) and also acts as the Layer 2 VMware low-level network driver for Broadcom's NetXtreme II 10G device. This driver directly controls the hardware and is responsible for sending and receiving Ethernet packets on behalf of the VMware host networking stack. The bnx2x driver also receives and processes device interrupts, both on behalf of itself (for L2 networking) and on behalf of the bnx2fc (FCoE protocol) and CNIC drivers.
bnx2fc	The Broadcom VMware FCoE driver is a kernel mode driver used to provide a translation layer between the VMware SCSI stack and the Broadcom FCoE firmware/hardware. In addition, the driver interfaces with the networking layer to transmit and receive encapsulated FCoE frames on behalf of open-fcoe's libfc/libfcoe for FIP/device discovery.

Supported Distributions

The FCoE/DCB feature set is supported on VMware ESXi 5.0 and above.

iSCSI Support

This following driver is provided to support iSCSI.

Table 3: Broadcom NetXtreme II iSCSI Driver

Driver	Description
bnx2i	The bnx2i driver is Broadcom VMware iSCSI HBA driver. Similar to bnx2fc, bnx2i is a kernel mode driver used to provide a translation layer between the VMware SCSI stack and the Broadcom iSCSI firmware/hardware. Bnx2i functions under the open-iscsi framework.

VLAN Configuration for iSCSI Offload (Linux)

iSCSI traffic on the network may be isolated in a VLAN to segregate it from other traffic. When this is the case, you must make the iSCSI interface on the adapter a member of that VLAN.

To configure the VLAN using the V-Sphere client (GUI):

1. Click the ESXi/ESX host.
2. Click the Configuration tab.
3. Click the **Networking** link and click **Properties**.
4. Click the virtual switch / portgroups in the Ports tab and click **Edit**.
5. Click the General tab.
6. Assign a VLAN number in VLAN ID (optional).

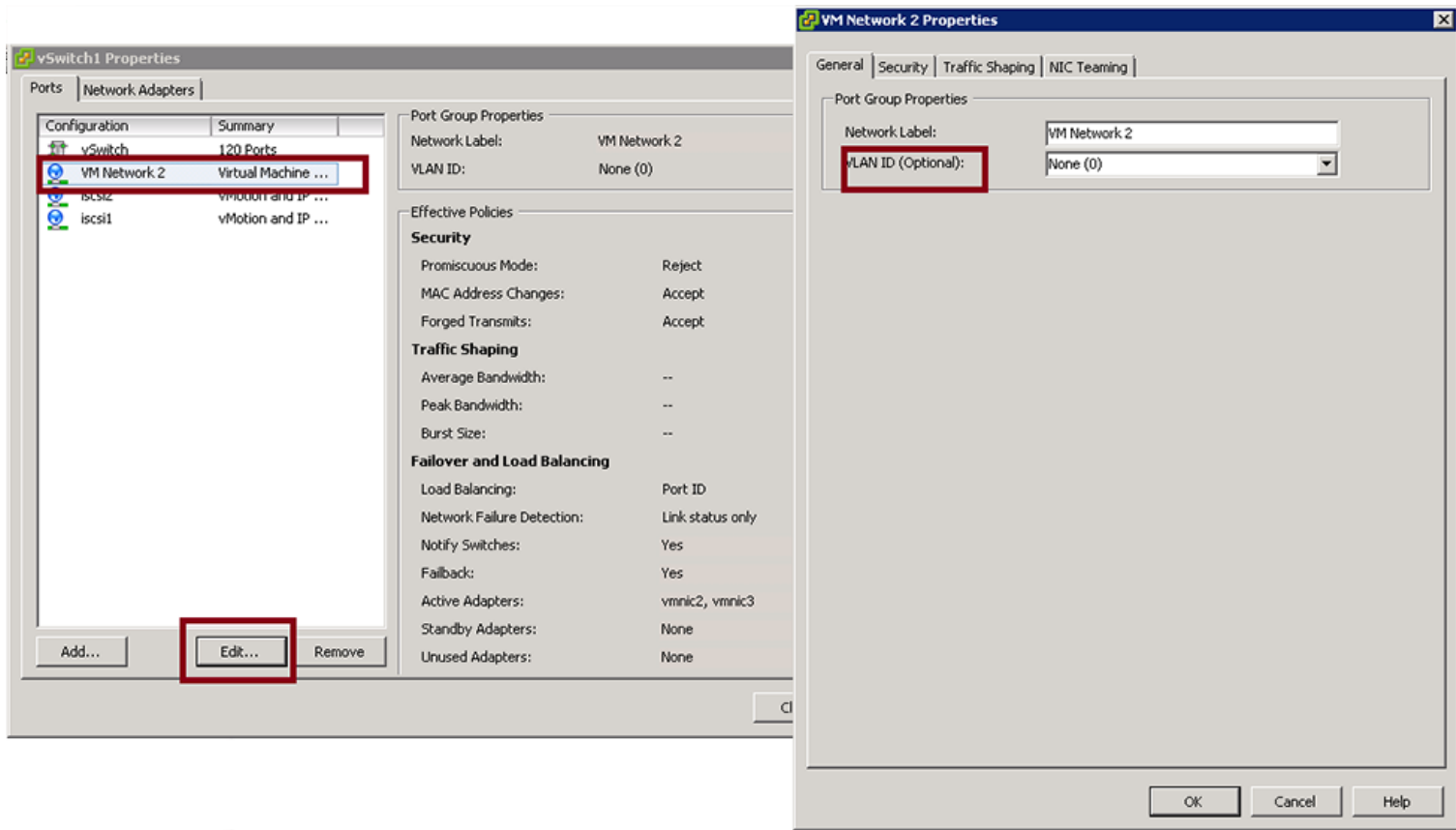

7. Configure the VLAN on VMKernel.

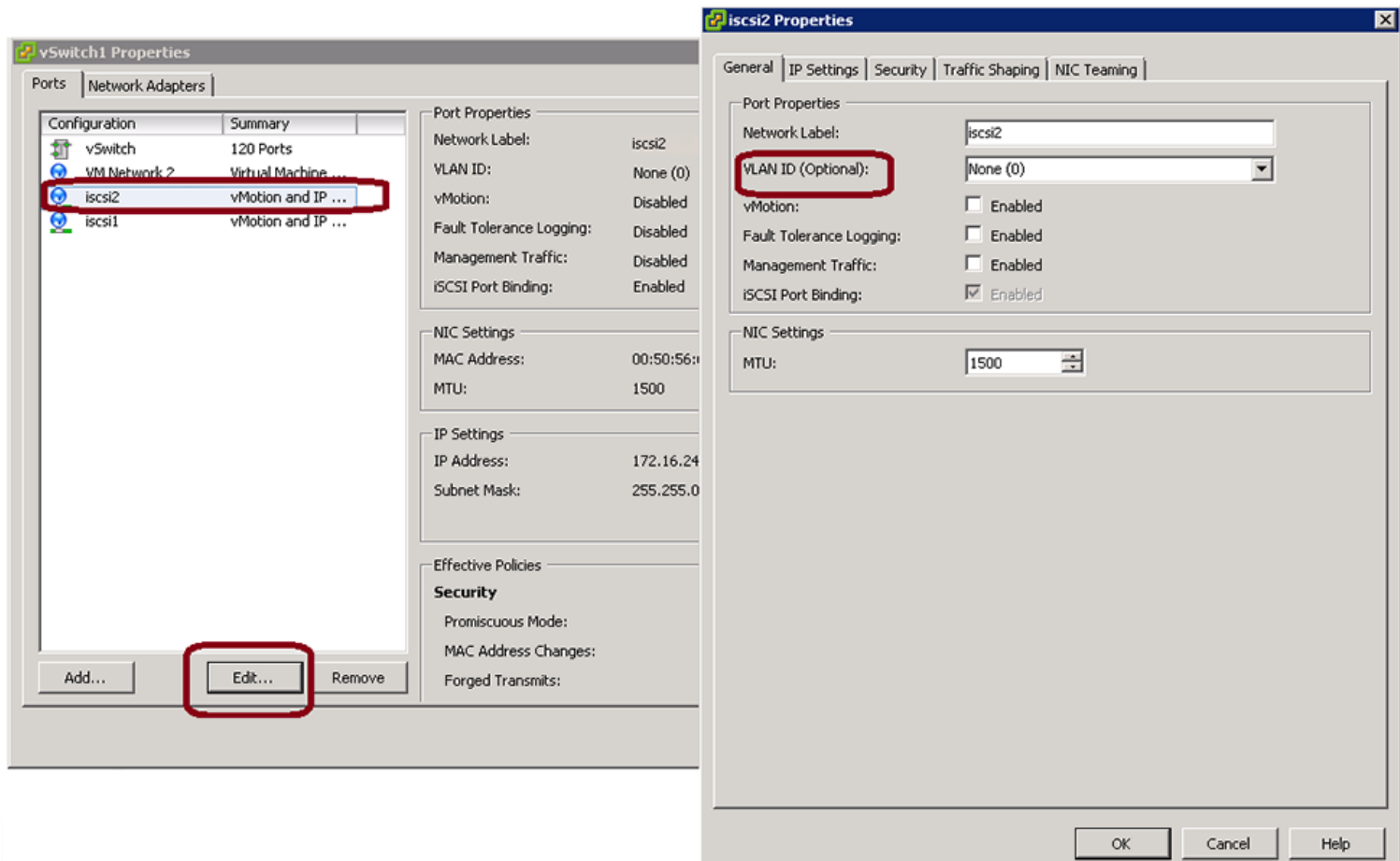

Enabling FCoE

To enable FCoE hardware offload on the C-NIC

1. Determine the ports that are FCoE-capable:

```
# esxcli fcoe nic list
```

Output example:

```
vmnic4
User Priority: 3
Source MAC: FF:FF:FF:FF:FF:FF
Active: false
Priority Settable: false
Source MAC Settable: false
VLAN Range Settable: false
```

1. Enable the FCoE interface:

```
# esxcli fcoe nic discover -n vmnicX
```

Where x is the interface number gained from **esxcli fcoe nic list**.

2. Verify that the interface is working:

```
# esxcli fcoe adapter list
```

Output example:

```
vmhba34
Source MAC: bc:30:5b:01:82:39
FCF MAC: 00:05:73:cf:2c:ea
VNPort MAC: 0e:fc:00:47:04:04
Physical NIC: vmnic7
User Priority: 3
VLAN id: 2008
```

The output of this command should show valid:

FCF MAC, VNPort MAC, Priority, and VLAN id for the Fabric that is connected to the C-NIC.

The following command can also be used to verify that the interface is working properly:

```
#esxcfg-scsidevs -a
```

Output example:

```
vmhba34 bnx2fc link-up fcoe.1000<mac address>:2000<mac address> () Software FCoE
vmhba35 bnx2fc link-up fcoe.1000<mac address>:2000<mac address> () Software FCoE
```

 **NOTE:** The label "Software FCoE" is a VMware term used to describe initiators that depend on the inbox FCoE libraries and utilities. Broadcom's FCoE solution is a fully state connection-based hardware offload solution designed to significantly reduce the CPU burden encumbered by a non-offload software initiator.

Installation Check

To verify the correct installation of the driver and to ensure that the host port is seen by the switch, follow the procedure below.

To verify the correct installation of the driver

1. Verify the host port shows up in the switch FLOGI database using the "show flogi database" command for the case of a Cisco FCF and "fcoe -loginshow" command for the case of a Brocade FCF.
2. If the Host WWPN does not appear in the FLOGI database, then provide driver log messages for review.

Limitations

- NPIV is not currently supported with this release on ESX, due to lack of supporting inbox components.
- Non-offload FCoE is not supported with offload-capable Broadcom devices. Only the full hardware offload path is supported.

Please read all [Restrictions and Disclaimers](#).

[Back to Contents Page](#)

[Back to Contents Page](#)

Windows Driver and Management Application Installation: Broadcom NetXtreme II® Network Adapter User Guide

- [Installing the Driver Software](#)
- [Modifying the Driver Software](#)
- [Repairing or Reinstalling the Driver Software](#)
- [Removing the Device Drivers](#)
- [Using the NetXtreme II Monolithic Driver](#)
- [Inserting the NetXtreme II Monolithic Driver in a WinPE 2.0 or 3.1 Image](#)
- [Configuring the Speed/Duplex Setting for the NetXtreme II Monolithic Driver](#)
- [Viewing or Changing the Properties of the Adapter](#)
- [Setting Power Management Options](#)
- [Configuring the Communication Protocol To Use With BACS4](#)

Installing the Driver Software

 **NOTE:** These instructions are based on the assumption that your Broadcom NetXtreme II adapter was not factory installed. If your controller was installed at the factory, the driver software has been installed for you.

When Windows first starts after a hardware device (such as a Broadcom NetXtreme II Adapter) has been installed, or after the existing device driver has been removed, the operating system automatically detects the hardware and prompts you to install the driver software for that device.

Both a graphical interactive installation mode (see [Using the Installer](#)) and a command-line silent mode for unattended installation (see [Using Silent Installation](#)) are available.

 **NOTES:**

- Before installing the driver software, verify that the Windows operating system has been upgraded to the latest version with the latest service pack applied.
- A network device driver must be physically installed before the Broadcom NetXtreme II Controller can be used with your Windows operating system. Drivers are located on the driver source media as well as at the Dell website at <http://support.dell.com>.
- To use the TCP/IP Offload Engine (TOE), you must have Windows Server 2008, Windows Server 2008 R2, or Windows Server 2012. You must also have a license key installed on the motherboard (for LOMs). For add-in NICs, the license key is preprogrammed in the hardware.
- BACS is not supported on the Server Core installation option for Microsoft Windows Server 2008 R2.

Using the Installer

In addition to the Broadcom device drivers, the installer installs the management applications. The following are installed when running the installer:

- **Broadcom Device Drivers.** Installs the Broadcom device drivers.
- **Control Suite.** Broadcom Advanced Control Suite (BACS).
- **BASP.** Installs Broadcom Advanced Server Program.
- **SNMP.** Installs the Simple Network Management Protocol subagent.
- **CIM Provider.** Installs the Common Information Model provider.
- **iSCSI Crash Dump Driver.** Installs the driver needed for the iSCSI Crash Dump utility.

 **NOTE:** Although installing the BACS software and related management applications is optional, the Broadcom device drivers must be installed when you use the installer.

 **NOTE:** BASP is not available on Windows Small Business Server (SBS) 2008.

To install the Broadcom NetXtreme II drivers and management applications

1. When the **Found New Hardware Wizard** appears, click **Cancel**.
2. Insert the Dell-provided CD into the CD or DVD drive or download the software driver package from the Dell website at <http://support.dell.com/>.
3. On the driver source media, or from the location to which you downloaded the software driver package, open the folder for your operating system, open the Driver_Management_Apps_Installer folder, and then double-click **Setup.exe** to open the InstallShield Wizard.
4. Click **Next** to continue.
5. After you review the license agreement, click **I accept the terms in the license agreement** and then click **Next** to continue.
6. Select the features you want installed.
7. Select how you want to install the NetXtreme II drivers and then click **Next**.
8. Click **Install**.
9. Click **Finish** to close the wizard.
10. The installer will determine if a system restart is necessary. Follow the on-screen instructions.

To install the Microsoft iSCSI Software Initiator for iSCSI Crash Dump

If supported and if you will use the Broadcom iSCSI Crash Dump utility, it is important to follow the installation sequence:

- Run the installer
- Install the Microsoft iSCSI Software Initiator along with the patch (MS KB939875)

 **NOTE:** If performing an upgrade of the device drivers from the installer, re-enable **iSCSI Crash Dump** from the Advanced section of the BACS Configuration tab.

Perform this procedure after running the installer to install the device drivers and the management applications.

1. Install Microsoft iSCSI Software Initiator (version 2.06 or later) if not included in your OS. To determine when you need to install the Microsoft iSCSI Software Initiator, see [Table 1](#). To download the iSCSI Software Initiator from Microsoft, go to <http://www.microsoft.com/en-us/download/details.aspx?displaylang=en&id=18986>.
2. Install Microsoft patch for iSCSI crash dump file generation (Microsoft KB939875) from <http://support.microsoft.com/kb/939875>. To determine if you need to install the Microsoft patch, see [Table 1](#).

Table 1: Windows Operating Systems and iSCSI Crash Dump

Operating System	MS iSCSI Software Initiator Required	Microsoft Patch (MS KB939875) Required
NDIS		
Windows Server 2008	Yes (included in OS)	No
Windows Server 2008 R2	Yes (included in OS)	No
Windows Server 2012	Yes (included in OS)	No
OIS		
Windows Server 2008	No	No
Windows Server 2008 R2	No	No
Windows Server 2012	No	No

Using Silent Installation

 **NOTES:**

- o All commands are case sensitive.

- o For detailed instructions and information about unattended installs, refer to the Silent.txt file in the Driver_Management_Apps_Installer folder.

To perform a silent install from within the installer source folder

Type the following:

```
setup /s /v/qn
```

To perform a silent upgrade from within the installer source folder

Type the following:

```
setup /s /v/qn
```

To perform a silent reinstall of the same installer

Type the following:

```
setup /s /v"/qn REINSTALL=ALL"
```

 **NOTE:** The REINSTALL switch should only be used if the same installer is already installed on the system. If upgrading an earlier version of the installer, use `setup /s /v/qn` as listed above.

To perform a silent install by feature

Use the ADDSOURCE to include any of the features listed below.

Type the following according to platform:

IA32 platforms: `setup /s /v"/qn ADDSOURCE=Driversi32,BACSi32,BASPi32,SNMPi32,CIMi32"`

AMD/EM64T platforms: `setup /s /v"/qn ADDSOURCE=Driversa64,BACSa64,BASPa64,SNMPa64,CIMa64"`

The following command-line statement installs only the Broadcom drivers according to platform:

IA32 platforms: `setup /s /v"/qn ADDSOURCE=Driversi32"`

AMD64 platforms: `setup /s /v"/qn ADDSOURCE=Driversa64"`

 **NOTE:** The Broadcom device drivers are a required feature and are always installed, even if you do not specify ADDSOURCE.

To perform a silent install from within a batch file

To perform a silent install from within a batch file and to wait for the install to complete before continuing with the next command line, type the following:

```
start /wait setup /s /w /v/qn
```

To perform a silent install to force a downgrade (default is NO)

```
setup /s /v" /qn DOWNGRADE=Y"
```

Modifying the Driver Software

To modify the driver software

1. In Control Panel, double-click **Add or Remove Programs**.
2. Click **Broadcom Drivers and Management Applications**, and then click **Change**.
3. Click **Next** to continue.
4. Click **Modify, Add, or Remove** to change program features. This option does not install drivers for new adapters. For information on installing drivers for new adapters, see [Repairing or Reinstalling the Driver Software](#).
5. Click **Next** to continue.
6. Click on an icon to change how a feature is installed.
7. Click **Next**.

8. Click **Install**.
9. Click **Finish** to close the wizard.
10. The installer will determine if a system restart is necessary. Follow the on-screen instructions.

Repairing or Reinstalling the Driver Software

To repair or reinstall the driver software

1. In Control Panel, double-click **Add or Remove Programs**.
2. Click **Broadcom Drivers and Management Applications**, and then click **Change**.
3. Click **Next** to continue.
4. Click **Repair or Reinstall** to repair errors or install drivers for new adapters.
5. Click **Next** to continue.
6. Click **Install**.
7. Click **Finish** to close the wizard.
8. The installer will determine if a system restart is necessary. Follow the on-screen instructions.

Removing the Device Drivers

When removing the device drivers, any management application that is installed is also removed.

 **NOTE:** Windows Server 2008 and Windows Server 2008 R2 provide the Device Driver Rollback feature to replace a device driver with one that was previously installed. However, the complex software architecture of the NetXtreme II device may present problems if the rollback feature is used on one of the individual components. Therefore, we recommend that changes to driver versions be made only through the use of a driver installer.

To remove the device drivers

1. In Control Panel, double-click **Add or Remove Programs**.
2. Click **Broadcom Drivers and Management Applications**, and then click **Remove**. Follow the on-screen prompts.
3. Reboot your system to completely remove the drivers. If you fail to reboot your system, you will not be able to successfully install the drivers.

Using the NetXtreme II Monolithic Driver

The NetXtreme II, based on its advanced functionalities, uses a software architecture that includes a Virtual Bus Device (VBD) to extend functionalities beyond basic network connectivity. Microsoft, however, does not currently support this architecture when loading an operating system through its Windows Deployment Services (WDS), which was previously known as Remote Installation Services (RIS), or for the deployment agent used in the Automated Deployment Services (ADS). Therefore, a separate driver was created to accommodate these Microsoft deficiencies. This driver is known as the NetXtreme II monolithic driver, but it is sometimes referred to as the "RIS" driver.

The NetXtreme II monolithic driver was developed to work only for the text mode portion of a WDS legacy installation and to establish connectivity with a deployment agent for ADS. It is not intended to be used as a driver loaded in the running state of an operating system. The exception to this would be when used for the Windows Preinstallation Environment (WinPE).

For WDS, this driver is used similarly to any other network adapter driver for supporting network connectivity after the PXE boot to the WDS server. When placed in the I386 or AMD64 directory (depending on the version of the operating system being deployed), the monolithic driver is called to establish that there is driver support for the NetXtreme II adapter included in the WDS legacy image.

For ADS, the driver is placed in the PreSystem directory on the server running ADS to establish connectivity with the deployment agent on remote systems with NetXtreme II adapters when booting from PXE.

While Windows PE 2005 natively supports the VBD architecture, it was found that using the "minint" switch in the startnet.cmd file does not. The minint switch performs a limited scan of the system bus to identify network devices only and, therefore, does not support the VBD architecture. Since only network connectivity is required in Windows PE, the only supported driver is the monolithic driver for the NetXtreme II adapter in this environment as well. Place the b06nd.inf file in the INF directory within the Windows PE image, and place the appropriate driver file (b06nd51a.sys for x64-based builds or

b06nd51.sys for x86-based builds) in the driver's directory. If Windows PE is deployed as a flat image from a RIS or WDS server, you must also place both the b06nd.inf and the appropriate driver file in the I386 or AMD64 directory containing the image. If the RIS or WDS server is running Windows 2000 Server and deploying an x86 WinPE image, you may need to apply the following modification to the b06nd.inf file located in the I386 directory as follows:

1. Locate [Manufacturer] header within the file.
2. Review the line below it which reads: %brcm% = broadcom, ntx86, ntamd64, ntia64 or equivalent.
3. Modify that line to read: %brcm% = broadcom.ntx86, ntamd64, ntia64. The change made replaces the comma and space after "broadcom" with a period.
4. Save the file.
5. Restart the RIS service (binlsv) or WDS services (wdsserver).

Inserting the NetXtreme II Monolithic Driver in a WinPE 2.0 or 3.1 Image

Follow these procedures for inserting the NetXtreme II monolithic driver into WinPE images. The instructions differ depending on the WinPE version and the Windows Server OS version system being used.

WinPE 2.0

The Microsoft Windows Server 2008 method of inserting the NetXtreme II monolithic driver in a WinPE 2.0 image is different from the Windows Server 2008 R2 method, as discussed below.

By default, the monolithic driver is not included in the boot.wim and install.wim files that come with either the Microsoft Windows Server 2008 CD or the Windows Server 2008 R2 CD. Microsoft's Windows Automated Installation Kit (AIK) allows you to modify the default boot.wim and install.wim files, and create WinPE 2.0 images to include the NetXtreme II monolithic driver in the Windows Server installation.

To insert the monolithic driver into a WinPE 2.0 boot image (Windows Server 2008)

To insert Broadcom's NetXtreme II monolithic driver in a WinPE 2.0 image, download AIK from <http://www.microsoft.com/en-us/download/default.aspx> and install.

After installing AIK, copy the latest monolithic driver to a directory on the local hard drive of the system you installed the AIK. Follow the procedure below to insert the monolithic driver into a WinPE 2.0 boot image.

1. From All Programs, open Windows AIK and select **Windows PE Tools Command prompt**.
2. At the command prompt, run the cotype.cmd script. The script requires two arguments: hardware architecture and destination location.

```
cotype.cmd <arch> <destination>
```

For example: `cotype x86 c:\VistaPEx86`

 **NOTE:** The directory structure c:\VistaPEx86 is used throughout this procedure.

3. Mount the base image to a local directory so that you can add or remove packages by typing:

```
imagex /mount /w c:\VistaPEx86\winpe.wim 1 c:\VistaPEx86\mount
```

4. Place the monolithic driver and inf file in c:\drivers\x32\ by typing:

```
peimg /inf=c:\Drivers\x32\b06nd.inf c:\VistaPEx86\mount\windows
```

AIK inserts the driver into the WinPE 2.0 image.

5. To complete the customization of the image, prepare the image for deployment, type:

```
peimg /prep c:\VistaPEx86\mount\windows
```

6. When asked to continue and have the program prepare the image for deployment, type:

```
yes
```

7. To commit the changes to the original image file (Winpe.wim), type:

```
imagex /unmount c:\VistaPEx86\mount /commit
```

8. To replace the default Boot.wim file in the \ISO directory with your new custom image, type:

```
copy c:\VistaPEx86\winpe.wim c:\VistaPEx86\ISO\sources\boot.wim
```

To add a device driver to an offline Windows PE image (Windows Server 2008 R2)

This procedure demonstrates how to use the Deployment Image Servicing and Management (DISM) tool to add a device driver (.inf) to an offline Windows PE image. Before running a DISM command, first mount the Windows PE image.

1. Mount the base image by using the DISM tool to a local Windows PE directory. For example:

```
Dism /Mount-WIM /WimFile:c:\winpe_x86\winpe.wim /index:1 /MountDir:c:\winpe_x86\mount
```

 NOTE: The directory structure c:\winpe_x86 is used throughout this procedure.

2. Add the .inf file to the base image by using the **dism** command with the **/Add-Driver** option. For example Driver.inf is the Broadcom driver, evnd.inf is the driver for the 10 Gbps devices, and b06nd.inf is the driver for the 1 Gbps devices.

```
Dism /image:<path_to_image> /Add-Driver /Driver:c:\winpe_x86\mount\Windows\driver.inf
```

3. Repeat steps 1 and 2 for each additional device driver.
4. Unmount the image after modifying it.

```
dism /unmount-wim /Mountdir:c:\winpe_x86\mount /commit
```
5. After unmounting the image, burn it to the designated media.

To create a bootable CD-ROM

1. On your technician computer, at the command prompt, create an .iso file by typing:

```
oscdimg -n -bc:\VistaPEx86\etfsboot.com c:\VistaPEx86\ISO C:\VistaPEx86\VistaPEx86.iso
```

2. Burn the iso image to a CD.

WinPE 3.1

To insert the NetXtreme II monolithic driver into a WinPE 3.1 boot image (Windows server 2008 R2 SP1)

1. Open the WinPE image and mount it:

```
Dism /Mount-WIM /WimFile:c:\WinPEx64\winpe.wim /index:1 /MountDir:c:\WinPEx64\mount
```

2. Use the following commands to insert the Broadcom NetXtreme II drivers into the WinPE 3.1 image:

eVBD driver:

```
Dism /image:c:\WinPEx64\mount /Add-Driver /Driver:c:\Drivers\x64\evbd.inf
```

NetXtreme I NDIS 5.1 driver:

```
Dism /image:c:\WinPEx64\mount /Add-Driver /Driver:c:\Drivers\x64\b57amd64.inf
```

NetXtreme II NDIS driver:

```
Dism /image:c:\WinPEx64\mount /Add-Driver /Driver:c:\Drivers\x64\bxnd.inf
```

NetXtreme I NDIS 6.0 driver:

```
Dism /image:c:\WinPEx64\mount /Add-Driver /Driver:c:\Drivers\x64\b57nd60a.inf
```

NetXtreme II VBD driver:

```
Dism /image:c:\WinPEx64\mount /Add-Driver /Driver:c:\Drivers\x64\bxvbd.inf
```

3. Close the WinPE image and unmount it:

```
Dism /unmount-wim /Mountdir:c:\WinPEx64\mount /commit
```

WinPE 4.0

To insert the NetXtreme II monolithic driver into a WinPE 4.0 boot image (Windows server 2008 R2 SP1)

Configuring the Speed/Duplex Setting for the NetXtreme II Monolithic Driver

Since the typical environment where the NetXtreme II monolithic driver is used does not provide the means to configure advanced network adapter properties, the driver file (b06nd.inf) was modified to include a section that allows it to be configured for a specific speed and/or duplex. This provides a more robust connection to the network as it allows the adapter to match the settings of its link partner (e.g., a switch, router, etc.).

To manually configure the speed and duplex

1. Open the b06nd.inf file with a text editor like Microsoft Notepad or WordPad.

2. Perform a search on the file for "Registry parameters" to locate the section that will allow you to configure the adapter speed/duplex.
3. Once located, notice the following information shown.

```
[params_utp]
hkr, , req_medium,          2, "0"
[params_fiber]
hkr, , req_medium,          2, "65283"
```

These make up two separate sections that can be configured: one for standard RJ-45 copper interfaces (params_utp) and one for fiber devices (params_fiber).

1. As described in the file, replace the value above in quotation marks under the correct section, depending upon the network adapter in your system. The available values are shown below.

Options for copper interfaces:

- o Auto (1 Gbps is enabled when that speed is supported) = "0"
- o 10 Mbps Half Duplex = "65794"
- o 10 Mbps Full Duplex = "258"
- o 100 Mbps Half Duplex = "66050"
- o 100 Mbps Full Duplex = "514"

Options for fiber interfaces:

- o Auto (1 Gbps is enabled when that speed is supported) = "0"
- o 1 Gbps Full Duplex = "771"
- o Auto with 1 Gbps Fallback = "33539"
- o Hardware default = "65283"

An example is provided in the file showing how to configure a copper interface for a 10 Mbps Full Duplex connection. The example is shown below.

```
hkr, , req_medium,          2, "258"
```

Viewing or Changing the Properties of the Adapter

To view or change the properties of the Broadcom network adapter

1. In Control Panel, click **Broadcom Control Suite 4**.
2. Click the Advanced section of the **Configurations** tab.

Setting Power Management Options

You can set power management options to allow the operating system to turn off the controller to save power or to allow the controller to wake up the computer. If the device is busy doing something (servicing a call, for example) however, the operating system will not shut down the device. The operating system attempts to shut down every possible device only when the computer attempts to go into hibernation. To have the controller stay on at all times, do not click the **Allow the computer to turn off the device to save power** check box.



NOTE: Power management options are not available on blade servers.

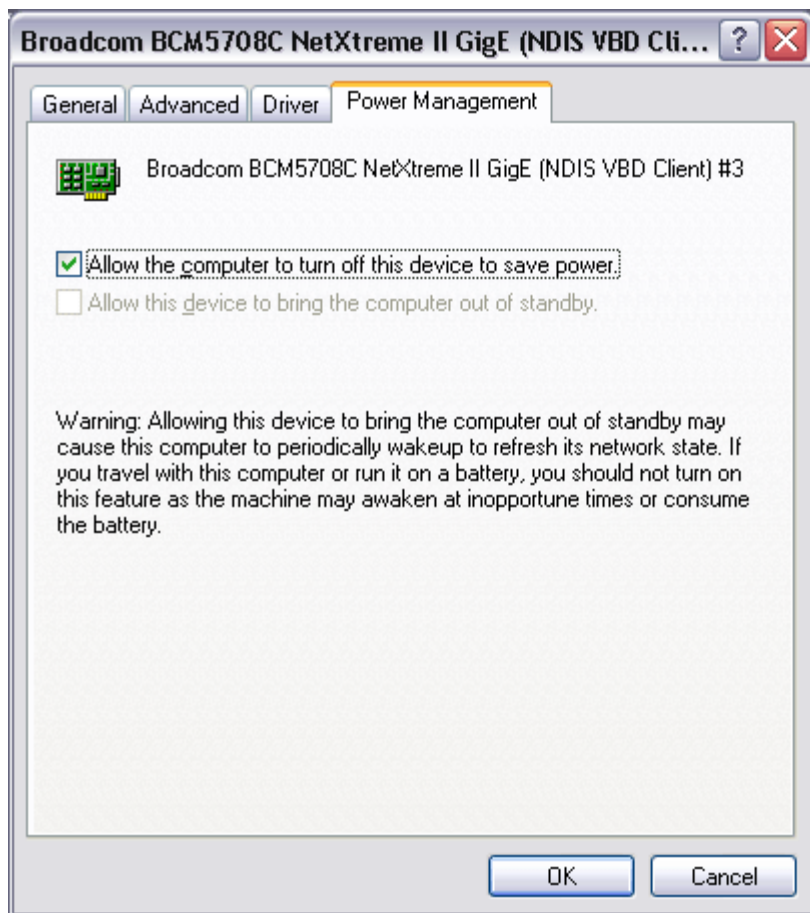

NOTES:

- o The Power Management tab is available only for servers that support power management.
- o To enable Wake on LAN (WOL) when the computer is on standby, click **Allow the device to bring the computer out of standby** box.
- o If you select **Only allow management stations to bring the computer out of standby**, the computer can be brought out of standby *only by Magic Packet*.

⚠ CAUTION! Do not select Allow the computer to turn off the device to save power for any adapter that is a member of a team.

Configuring the Communication Protocol To Use With BACS4

There are two main components of the BACS4 management application: the provider component and the client software. A provider is installed on a server, or managed host, that contains one or more CNAs. The provider collects information on the CNAs and makes it available for retrieval from a management PC on which the client software is installed. The client software enables viewing information from the providers and configuring the CNAs. The BACS client software includes a graphical user interface (GUI) and a command line interface (CLI).

A communication protocol enables communication between the provider and the client software. Depending on the mix of operating systems (Linux, Windows, or both) on the clients and managed hosts in your network, you can choose an appropriate communication protocol to use. See [Installing the Broadcom Advanced Control Suite](#) in the "[Linux Management Application Installation](#)" topic for a description of the available communication protocols for each network configuration.

The instructions in this chapter address only the scenario where Windows managed hosts are communicating with Windows clients. In these scenarios, you can use either the WMI or the WS-MAN (WinRM) communication protocols. When you use the driver installer described in this chapter to install both the driver and the management applications, the provider for both WMI and WS-MAN is installed on the managed host. Additionally, the BACS4 utility is installed on the client. The following sections provide additional configuration steps for the communication protocol you select.

For Linux installations, the driver is installed separately from the management applications. See [Linux Driver Software](#) and see [Linux Management Application Installation](#) for related instructions.

Using WS-MAN

To use the WS-MAN communication protocol, follow the instructions in the following sections:

- [WS-MAN Windows Server Configuration](#)
- [WS-MAN Windows Client Installation](#)

WS-MAN Windows Server Configuration

Step 1: Install the WinRM Software Component on Server

On the following operating systems, WinRM 2.0 is preinstalled:

- Windows 7
- Windows 8
- Windows 8.1
- Windows Server 2008 R2
- Windows Server 2012
- Windows 2012 R2

For Windows XP and Windows Server, 2008, install Windows Management Framework Core, which includes WinRM 2.0 and Windows Powershell 2.0, from the following link:

<http://www.microsoft.com/download/en/details.aspx?displaylang=en&id=11829>

Step 2: Perform Basic Configuration on the Server

The Windows firewall must be enabled for WinRM to work properly. For detailed information about firewall configuration, see [Step 7: Additional Server Configuration](#). After the firewall is configured, open a command prompt and run the following command to enable the remote management on the Windows server:

```
winrm quickconfig
```

You can use the following command to view the configuration information for the service:

```
winrm get winrm/config
```

Step 3: Perform User Configuration on the Server

To connect to WinRM, the account must be a member of the local administrators group on the local or remote computer. The output of the get winrm/config command will be as follows:

```
RootSDDL = O:NSG:BAD:P(A;;GA;;;BA)S:P(AU;FA;GA;;;WD)(AU;SA;GWGX;;;WD)
```

BA stands for BUILTIN\Administrators.

To add another user group to the WinRM allowed connect list, you can modify the RootSDDL to include the new user group. You will need the SDDL ID for the new group. For example, the following command adds the new user group with SDDL ID S-1-5-21-1866529496-2433358402-1775838904-1021.

```
winrm set winrm/config/Service @{RootSDDL="O:NSG:BAD:P(A;;GA;;;BA)(A;;GA;;;S-1-5-21-1866529496-2433358402-1775838904-1021)S:P(AU;FA;GA;;;WD)(AU;SA;GWGX;;;WD)"} 
```

Step 4: Perform HTTP Configuration on the Server

To use the BACS GUI, you must configure the HTTP protocol, as follows:

 NOTE: The default HTTP port is 5985 for WinRM 2.0.

1. Click **Start** (or press the Windows logo key) and select **Run**.
2. Enter **gpedit.msc** to open the local Group Policy editor.

3. Under **Computer Configuration**, open the **Administrative Templates** folder and then open the **Windows Components** folder.
4. Select **Windows Remote Management (WinRM)**.
5. Under **Windows Remote Management (WinRM)**, select **WinRm Client**.
6. Under **WinRM Client**, double-click **Trusted Hosts**.
7. In the **TrustedHostsList**, enter the host names of the clients. If all clients are trusted then enter an asterisk (*) only.
8. Select **WinRM Service**.
9. Enable **Allow Basic Authentication**.
10. Enable **Allow unencrypted traffic**.
11. Close the **Group Policy** window.
12. From the command prompt, run the following command to configure WinRM with default settings:

```
winrm qc or winrm quickconfig
```
13. When the tool displays "**Make these changes[y/n]?**", enter "**y**".
14. Enter one of the following commands to check whether an HTTP listener is created:

```
winrm enumerate winrm/config/listener
```

or

```
winrm e winrm/config/Listener
```
15. Enter the following command from the command prompt to test locally.

```
winrm id
```

Step 5: Perform HTTPS Configuration on the Server (to use HTTPS rather than HTTP)

This step consists of two distinct processes: generating a self-signed certificate, if certificate does not exist, and importing it to a Windows server. If one does not already exist, you must configure a self-signed certificate on the Windows server to enable HTTPS/SSL communication with the BACS GUI on the Windows client. The Windows client also must be configured with the self-signed certificate. See [Perform HTTPS Configuration \(if you plan to use HTTPS\)](#).

 **NOTE:** The self-signed certificate can be created on any Windows server. The server does not require BACS to be installed. The self-signed certificate generated on any Windows server should be copied on the local drive of client.

1. Click **Start** (or press the Windows logo key) and select **Run**.
2. Enter **gpedit.msc** to open the local Group Policy editor.
3. Under **Computer Configuration**, open the **Administrative Templates** folder and then open the **Windows Components** folder.
4. Select **Windows Remote Management (WinRM)**.
5. Under **Windows Remote Management (WinRM)**, select **WinRm Client**.
6. Under **WinRM Client**, double-click **Trusted Hosts**.
7. In the **TrustedHostsList**, enter the host names of the clients. If all clients are trusted then enter an asterisk (*) only.
8. Select **WinRM Service**.
9. Enable **Allow Basic Authentication**.

To generate a self-signed certificate for the Windows Server:

Openssl on Windows can be used to generate the self-signed certificate, as follows:

 **NOTE:** You can download and install openssl from <http://gnuwin32.sourceforge.net/packages/openssl.htm>.

1. Enter the following command to generate a private key:

```
openssl genrsa -des3 -out server.key 1024
```
2. You are prompted to enter a passphrase. Be sure to remember the passphrase.
3. Use the following steps to generate a Certificate Signing Request (CSR).

During the generation of the CSR, you are prompted for several pieces of information. When prompted for the "Common Name", enter the Windows Server host name or IP address.

Enter the following command (sample responses are shown):

```
openssl req -new -key server.key -out server.csr
```

If this command does not work, try the following:

```
openssl req -new -key server.key -out server.csr -config openssl.cnf
```

The openssl.cnf file should be placed in the same directory where openssl is placed. Openssl.cnf is located in the folder C:\Program Files (x86)\GnuWin32\share.

The following information is requested:

- o Country Name (2 letter code) []: **US**
- o State or Province Name (full name) []: **California**
- o Locality Name (e.g., city) []: **Irvine**
- o Organization Name (e.g., company) []: **Broadcom Corporation**
- o Organizational Unit Name (e.g., section) []: **Engineering**
- o Common Name (e.g., YOUR name) []: Enter the host name or IP address of the Windows server. For IPv6, enter the Common Name in the format [xyxy:xxx:.....:xxx], **including the brackets []**.
- o (Optional) Email Address []:

Enter the following additional attributes to be sent with your certificate request:

- o A challenge password []: **password1**
- o An optional company name []:

4. Remove the passphrase from the key.

Enter the following commands:

```
cp server.key server.key.org
openssl rsa -in server.key.org -out server.key
```

5. Generate a self-signed certificate:

To generate a self-signed certificate which is active for 365 days, enter the following command:

```
openssl x509 -req -days 365 -in server.csr -signkey server.key -out server.crt
```

The following output displays:

```
Signature ok
subject=/C=US/ST=California/L=Irvine/O=Broadcom Corporation/OU=Engineering/CN=MGMTAPP-
LAB3/emailAddress=
Getting Private key
```

6. Enter the following command to verify the generated self-signed certificate.

```
openssl verify server.crt
```

The following output displays:

```
server.crt:/C=US/ST=California/L=Irvine/O=Broadcom Corporation/OU=Engineering/CN=MGMTAPP-
LAB3/emailAddress=
error 18 at 0 depth lookup:self signed certificate
OK
```

Ignore the error message "error 18 at 0 depth lookup:self signed certificate". This error indicates that this is a self-signed certificate.

7. Convert the certificate from "crt" to "pkcs12" format, as follows:

For a Windows server, the certificate should be in pkcs12 format. Enter the following command:

```
openssl pkcs12 -export -in server.crt -inkey server.key -out hostname.pfx
```

You will be prompted for the following:

```
Enter Export Password:
Verifying - Enter Export Password:
```

Enter the password and be sure to remember it. The password is required when importing the certificate on the Windows server and client.

8. Make a copy of the certificate file server.crt and place it on the server where BACS will be installed, so that it can be

imported. If you plan to use a Windows client to connect to the server running BACS, then the certificate also needs to be transferred (copied and pasted) to the client system.

To instal the self-signed certificate on Windows server:

Transfer the file *hostname.pfx* you generated on the Windows server before you install the certificate:

1. Click **Start** (or press the Windows logo key) and select **Run**.
2. Enter **MMC** and click **OK**.
3. Click **File** > **Add/Remove Snap-in**.
4. Click **Add**.
5. Select **Certificates** and click **Add**.
6. Select **Computer account**.
7. Click **Next** and then click **Finish**.
8. Click **Close**, then click **OK**.
9. Open the **Certificates (Local Computer)** folder and then open the **Personal** folder.
10. Right-click **Certificates**, select **All Tasks** and then click **Import**.
11. Click **Next** to begin the Certificate Import Wizard.
12. Browse to select **hostname.pfx**.
13. When you are prompted for the password for the private key, enter the same password you created in [To generate a self-signed certificate for the Windows Server:](#)
14. Follow the instructions, select the defaults, and continue.

The certificate is shown as installed on the right side of the window. The name will be the name you specified while creating a self-signed certificate.

15. Right-click on the certificate and select **Properties**.

A dialog box displays, as follows:

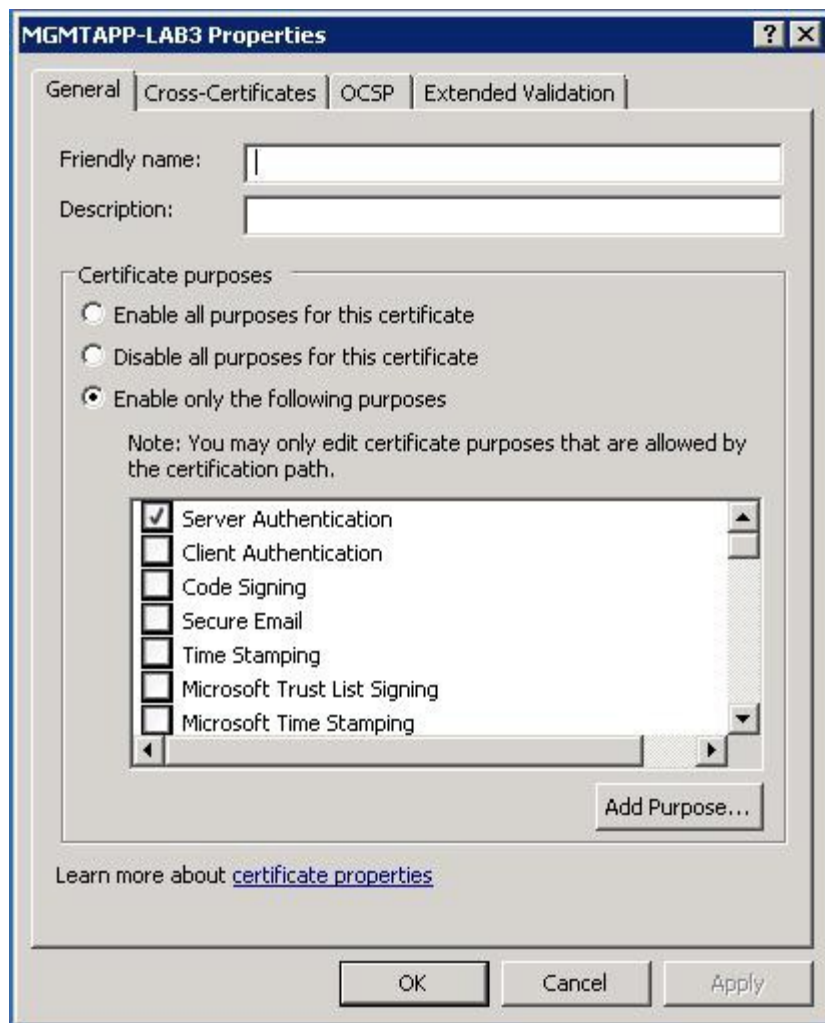

16. Ensure that only **Server Authentication** is enabled, as shown in the figure.
17. Open **Trusted Root Certification Authorities** and then open **Certificates**.
18. Follow the instructions from [Step 11.](#) to [Step 17.](#)

 **NOTE:** See [Perform HTTPS Configuration \(if you plan to use HTTPS\)](#) for instructions on importing the self-signed certificate on a client.

Step 6: Configure WinRM HTTPS/SSL on the Server

1. Create WinRM Listener, as follows:
 - a. Click **Start** (or press the Windows logo key) and select **Run**.
 - b. Enter **MMC** and click **OK**.
 - c. Select the self-signed certificate from the Personal store.

For example, if the certificate is created with a host name, the host name will appear.

- d. Double-click the certificate to open it.
- e. Click the **Details** tab.
- f. Scroll down and select the **Thumbprint** field.
- g. Select and copy the thumbprint in the **Details** window so you can insert it in the next step.
- h. Return to the command prompt.
- i. Enter the following command:

```
winrm create winrm/config/Listener?Address=*&Transport=
HTTPS @{{Hostname="<HostName or IPAddress>";
CertificateThumbprint="<paste from the previous step and remove the spaces>"}}
```

**NOTES:**

- If the certificate was generated using the host name, enter the host name. If it was generated using the IP address, enter the IP address. For an IPv6 address, use brackets [] around the address.
- If HTTPS is configured in your system, the listener must be deleted before creating a new HTTPS listener. Use the following command:
winrm delete winrm/config/Listener?Address=*&Transport=HTTPS

- j. The above command creates a listener on the HTTPS port (5986) using any/all network address of the server, and my SelfSSL generated certificate.
- k. You can use the winrm command to modify or set the HTTPS listener, as WinRM listeners can be configured on any user defined port.
- l. From command prompt, run the following command to verify that the listener(s) that have been configured:

```
winrm e winrm/config/listener
```

2. Test HTTPS/SSL connection on the server.

- a. At the command prompt on the server, enter the following command:

```
winrs -r:https://yourserver:5986 -u:username -p:password hostname
```

- b. If setup correctly, the output of the command shows the server host name.

- c. To check WinRM Service Configuration, run the following command:

```
winrm get winrm/config/service
```

Step 7: Additional Server Configuration

If necessary, modify the firewall rules as follows:

Windows Server 2008 R2

1. From the **Administrative Tools** menu, open **Windows Firewall with Advanced Security**.
2. Right-click **Inbound Rules** and select **New Rule**.

The new rule wizard opens.

3. Select **Port** and click **Next**.
4. On the **Protocol and Ports** screen, select **TCP** and enter the specific port, for example, 5985 for HTTP or 5986 for HTTPS.
5. Click **Next**.
6. On the **Action** screen, select **Allow the connection** and click **Next**.
7. For **Profile**, you can select all three profiles if your server is in a workgroup.
8. Specify a name for the rule and click **Finish**.
9. Ensure that the new rule and is enabled (the green check box is selected).

Windows XP

1. Click **Start > Control Panel**, and then double-click **Windows Firewall**.
2. Click the **Exceptions** tab
3. Click **Add Port**.
4. Enter a meaningful **Name**, for example "WinRM rule" and port number, for example, 5985 for HTTP or 5986 for HTTPS.
5. Click **OK**.

Useful WinRM Commands

Command	Description
winrm quickconfig or winrm qc	Configures WinRM with default settings

<code>winrm enumerate winrm/config/Listener</code> OR <code>winrm e winrm/config/Listener</code>	Helps to check which service listener are enabled and listening on which port and IP Address.
<code>winrm get winrm/config/Service</code>	Checks WinRM Service Configuration.
<code>winrm delete winrm/config/Listener? Address=*&Transport=HTTPS</code>	Deletes a Listener (in this case deleting a HTTPS listener).

Useful WinRM Websites

- <http://msdn.microsoft.com/en-us/library/aa384372%28v=vs.85%29.aspx>
- <http://technet.microsoft.com/en-us/library/cc782312%28WS.10%29.aspx>
- <http://msdn.microsoft.com/en-us/library/aa384295%28v=VS.85%29.aspx>
- The following articles on "<http://support.microsoft.com>":
 - "Configuring WINRM for HTTPS"
 - "Windows Management Framework (Windows PowerShell 2.0, WinRM 2.0, and BITS 4.0)"

WS-MAN Windows Client Installation

On the Windows client, perform following configuration steps.

1. Perform HTTP Configuration (if you plan to use HTTP)
 - a. Click **Start** (or press the Windows logo key) and select **Run**.
 - b. Enter **gpedit.msc** to open the local Group Policy editor.
 - c. Under **Computer Configuration**, open the **Administrative Templates** folder and then open the **Windows Components** folder.
 - d. Select **Windows Remote Management (WinRM)**.
 - e. Under **Windows Remote Management (WinRM)**, select **WinRm Client**.
 - f. Under **WinRM Client**, double-click **Trusted Hosts**.
 - g. In the **TrustedHostsList**, enter the host names of the clients and click **OK**. If all clients are trusted then enter an asterisk (*) only.
 - h. Select **WinRM Service**.
 - i. Enable **Allow Basic Authentication** and click **OK**.
 - j. Run the following command from the command prompt to test the connection:

```
winrm id -remote:<remote machine Hostname or IP Address>
```
2. Perform HTTPS Configuration (if you plan to use HTTPS)

After you generate a self-signed certificate, as described in [To generate a self-signed certificate for the Windows Server](#), you can import the certificate on the client to facilitate a connection between server and client. Ensure that all steps mentioned in section [To generate a self-signed certificate for the Windows Server](#) are completed, including copying *hostname.pfx* at the location from where client can access it, before you proceed with the following steps.

- a. Click **Start** (or press the Windows logo key) and select **Run**.
- b. Enter **MMC** and click **OK**.
- c. Click **File** and select **Add/Remove Snap-in**.
- d. Click **Add**.
- e. Select **Certificates** and click **Add**.
- f. Select **Computer account** and click **Next**.
- g. Click **Finish**.
- h. Click **Close** and then click **OK**.
- i. Under **Certificates (Local Computer)**, right-click on **Trusted Root Certification Authorities**, select **All Tasks**, and select **Import**.
- j. Click **Next** to begin the Certificate Import Wizard.

- k. Browse to select the .pfx file you generated in [To generate a self-signed certificate for the Windows Server:](#) . Change the selection in the **Files of type** list to **Personal Information Exchange (*.pfxas, *.p12)**, select the *hostname.pfx* file and click **Open**.
- l. Enter the password you assigned to the private key and click **Next**.

3. Configure WinRM HTTPS/SSL

You can run `winrm` from a client to retrieve information from the server using WinRM HTTPS connection. Use the following steps to test the WinRM HTTPS/SSL connection from client:

- a. To retrieve the server operating system information, enter the following command.

```
u:username          winrm e wmi/root/cimv2/Win32_OperatingSystem -r:https://yourservername -
                    -p:password -skipCAcheck
```

- b. To retrieve the server WinRM identity information, enter the following command.

```
winrm id -r:https://yourservername -u:username -p:password -skipCAcheck
```

- c. To enumerate Windows services on the server, enter the following command.

```
p:password -       winrm e wmicimv2/Win32_service -r:https://yourservername -u:username -
                    skipCAcheck
```

 **NOTE:** It is important to use `-skipCAcheck` switch in the `winrm` command line testing, as the certificate is self-generated and not imported on the client. Otherwise, the following error message displays: `WSManFault`.

Using WMI

No special configuration is required to use WMI on the Windows client. Perform the steps in the following sections to configure WMI on the Windows server.

Step 1: Set up Namespace Security Using WMI Control

The WMI Control provides one way to manage namespace security. You can start the WMI Control from the command prompt using this command:

```
wmimgmt
```

On Windows 9x or Windows NT4 computers that have WMI installed, use this command instead:

```
wbemnt1.exe
```

Alternatively, you can access the WMI Control and the Security tab as follows:

1. Right-click on **My Computer** and click **Manage**.
2. Double-click **Services and Applications** and then double-click **WMI Control**.
3. Right-click **WMI Control** and then click **Properties**.
4. In WMI Control Properties, click the **Security** tab.
5. A folder named Root with a plus sign (+) next to it should now be visible. Expand this tree as necessary to locate the namespace for which you want to set permissions.
6. Click **Security**.

A list of users and their permissions appears. If the user is on the list, modify the permissions as appropriate. If the user is not on the list, click **Add** and add the user from the location (local machine, domain, etc.) where the account resides.

 **NOTES:** You can add these exports at the end of the `.bash_profile`. This file is located in the `/root` directory.

- o In order to view and set namespace security, the user must have Read Security and Edit Security permissions. Administrators have these permissions by default, and can assign the permissions to other user accounts as required.
- o If this user needs to access the namespace remotely, you must select the Remote Enable permission.
- o By default, user permissions set on a namespace apply only to that namespace. If you want the user to have access to a namespace and all subnamespaces in the tree below it, or in subnamespaces only, click **Advanced**. Click **Edit** and specify the scope of access in the dialog box that displays.

Step 2: Grant DCOM Remote Launch and Activate Permission

In the Windows domain environment, the Domain Administrator account has the necessary privilege level to access the WMI component for BACS management and, therefore, no special configuration is needed. In a large enterprise, however, a user who is accessing the local or remote host using the BACS4 client GUI may not always have the domain administrator account privilege. It is necessary to configure WMI security access on the remote host to allow the user to connect to it using the BACS4 client GUI.

This configuration can be easily done using the following procedure. If you do not have sufficient privileges to configure security for WMI access, contact your Network Administrator.

1. Click **Start** (or press the Windows logo key) and select **Run**.
2. Enter **DCOMCNFG**, and then click **OK**.
3. The Component Services dialogue box displays.
4. Open **Component Services** and then open **Computers**.
5. Right-click **My Computer** and click **Properties**.
6. In **My Computer Properties**, click the **COM Security** tab.
7. Under **Launch and Activation Permissions**, click **Edit Limits**.
8. Follow these steps if your name or your group does not appear in the **Groups or user names** list.
 - a. In the Launch Permission dialog box, click **Add**.
 - b. In the Select Users, Computers, or Groups dialog box, add your name and the group in the **Enter the object names to select** box, and then click **OK**.
 - c. In the Launch Permission dialog box, select your user and group in the **Group or user names** list.
 - d. In the **Permissions for User** area, select **Allow** for **Remote Launch** and **Remote Activation**, and then click **OK**.

Figure 1: Launch and Activation Permission

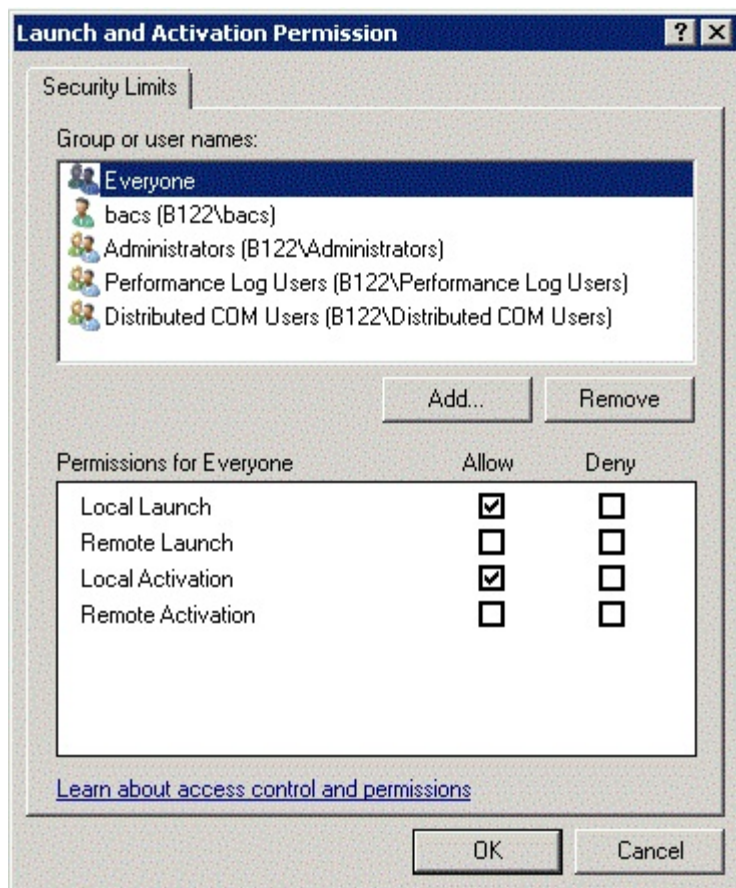

For more information, see [Securing a Remote WMI Connection](#) on the Microsoft Developer Network site.

Special Configuration for WMI on Different Systems

- On a Windows XP Pro computer, ensure that remote logons are not being coerced to the GUEST account (referred to as "ForceGuest", which is enabled by default on computers that are not attached to a domain). Open the Local Security Policy editor by clicking **Start > Run** and entering **secpol.msc**. Open the **Local Policies** node and select **Security Options**. Then, scroll down to the setting titled **Network access: Sharing and security model for local accounts**. If this is set to **Guest only**, change it to **Classic** and restart the computer.
- In Windows Vista and Windows 7, in order to let all users in the administrator group connect using the WMI namespace, the user might need to change the LocalAccountTokenFilterPolicy as needed.

Please read all [Restrictions and Disclaimers](#).

[Back to Contents Page](#)

[Back to Contents Page](#)

Linux BACS Installation: Broadcom NetXtreme II® Network Adapter User Guide

- [Overview](#)
- [Installing WS-MAN or CIM-XML on Linux Server](#)
- [Installing WS-MAN or CIM-XML on Linux Client](#)
- [Installing the Broadcom Advanced Control Suite](#)

Overview

The Broadcom Advanced Control Suite version 4 (BACS4) is a management application for configuring the NetXtreme II family of adapters, also known as Converge Network Adapters (CNAs). BACS4 software operates on Windows and Linux server and client operating systems. This chapter describes how to install the BACS4 management application.

This chapter describes how to install the BACS4 management application on Linux systems. For Windows systems, an installation program is provided which installs both the Windows drivers and the management applications, including BACS4 (see [Windows Driver and Management Application Installation](#) for instructions).

There are two main components of the BACS4 utility: the provider component and the client software. A provider is installed on a server, or "managed host", that contains one or more CNAs. The provider collects information on the CNAs and makes it available for retrieval from a management PC on which the client software is installed. The client software enables viewing information from the providers and configuring the CNAs. The BACS client software includes a graphical user interface (GUI) and a command line interface (CLI).

Communication Protocols

A communication protocol enables exchanging information between provider and the client software. These are proprietary or open-source implementations of the Web-Based Enterprise Management (WBEM) and Common Information Model (CIM) standards from the Distributed Management Task Force (DMTF). Network administrators can choose the best option based on the prevailing standard on their network.

The following table shows the available options based on the operating systems installed on the managed host and the client.

If the client uses:	And the managed host uses:	BACS can use these communication protocols:
Windows	Windows	WMI WS-MAN (WinRM)
Windows	Linux	CIM-XML (OpenPegasus) WS-MAN (OpenPegasus)
Linux	Windows	WS-MAN (WinRM)
Linux	Linux	CIM-XML (OpenPegasus) WS-MAN (OpenPegasus)

- WMI = Windows Management Instrumentation.
- WS-MAN = Web Service-Management. WinRM is a Windows-based implementation and OpenPegasus is an open-source implementation of the that operates on Linux.
- CIM-XML = An XML-based version of OpenPegasus.

If your network includes a mix of Windows and Linux clients accessing Windows and Linux servers, then WS-MAN is a suitable choice. If Linux is the only OS installed on the servers, then CIM-XML is an option. If the network includes only Windows servers and clients, WMI is an option. WMI is very simple to configure but is supported only on the Windows OS. (See [Windows Driver and Management Application Installation](#) for instructions on installing and configuring the Windows protocols.)

BACS installation includes installing the provider component on the managed host and the client software on the management station. The installation process differs based on the combination of operating systems installed on the client and managed

host and on the selected communication protocol.

Installing WS-MAN or CIM-XML on Linux Server

Step 1: Install OpenPegasus

On the Red Hat Linux OS, two installation options are available:

- [From the Inbox RPM \(Red Hat Only\)](#)
- [From Source \(Red Hat and SuSE\)](#)

On the SUSE Linux Enterprise Server 11 (SLES11) OS, you must use the source RPM.

 **NOTE:** The Inbox RPM does not support the WS-MAN communication protocol. To use WS-MAN, you must install OpenPegasus from source.

From the Inbox RPM (Red Hat Only)

In Red Hat Linux, an Inbox OpenPegasus RPM is available as `tog-pegasus-<version>.<arch>.rpm`.

1. Use the following command to install `tog-pegasus`:

```
rpm -ivh tog-openpegasus-<version>.<arch>.rpm
```
2. Use the following command to start Pegasus:

```
/etc/init.d/tog-pegasus start
```

 **NOTE:** If your system has "Red Hat Security Enhancement for tog-pegasus" enabled, disable it before connecting to BACS. See `/usr/share/doc/tog-pegasus-2.5.2/README.RedHat.Security` for details. To disable it, remove the line from `/etc/pam.d/wbem`.

 **NOTE:** On SuSE Linux, the Inbox OpenPegasus RPM is not available. OpenPegasus must be installed from source, as described in the following section.

Note that in inbox Pegasus, HTTP is not enabled by default. After Inbox OpenPegasus is installed successfully, if no further configuration is required, then follow the instructions in [Step 4: Install Broadcom CMPI Provider](#). To enable HTTP, see [Enable HTTP](#).

 **NOTE:** After the server is rebooted, the CIM server must be manually restarted to enable the client to reconnect to the server. This is a known limitation of Red Hat v6.2 Inbox RPM.

From Source (Red Hat and SuSE)

The OpenPegasus source can be downloaded from www.openpegasus.org.

 **NOTES:**

- If not already installed, download and install the `openssl` and `libopenssl-devel` rpm. This step is optional and required only if you are planning to use HTTPS to connect the client to the managed host.
- In some cases, if OpenPegasus installation fails, `openssl` must be installed with the `-fPIC` option:

```
./config no-threads --fPIC
```

This installs `openssl` and the include files to `/usr/local/ssl`. Set the `OPENSSL_HOME` path to `/usr/local/ssl` and continue with the OpenPegasus installation.

Set the Environment Variables

Set the environment variables for building OpenPegasus as follows.

Environment Variable	Description
PEGASUS_ROOT	The location of the Pegasus source tree
PEGASUS_HOME	The location for the built executable, repository; e.g., <code>\$PEGASUS_HOME/bin</code> , <code>PEGASUS_HOME/lib</code> , <code>\$PEGAUS_HOME/repository</code> , and <code>\$PEGASUS_HOME/mof</code> subdirectories.

PATH	\$PATH: \$PEGASUS_HOME/bin
PEGASUS_ENABLE_CMPI_PROVIDER_MANAGER	True
PEGASUS_CIM_SCHEMA	"CIM222"
PEGASUS_PLATFORM	For Linux 32 bit systems: "LINUX_IX86_GNU" For Linux 64 bit systems: "LINUX_X86_64_GNU"
PEGASUS_HAS_SSL	Optional. Set to "true" for HTTPS support.
PEGASUS_ENABLE_PROTOCOL_WSMAN	Optional. Set to "true" for WSMAN protocol support.

Additional Settings

The \$PEGASUS_HOME variable must be set up in the shell environment, and \$PEGASUS_HOME/bin needs to be appended to the \$PATH environment.

Examples

- export PEGASUS_PLATFORM="LINUX_X86_64_GNU"
- export PEGASUS_CIM_SCHEMA="CIM222"
- export PEGASUS_ENABLE_CMPI_PROVIDER_MANAGER=true
- export PEGASUS_ROOT="/share/pegasus-2.10-src"
- export PEGASUS_HOME="/pegasus"
- export PATH=\$PATH:\$PEGASUS_HOME/bin

For SSL Support, add the following environment variable:

- export PEGASUS_HAS_SSL=true

For WS-MAN Support, add the following environment variable:

- export PEGASUS_ENABLE_PROTOCOL_WSMAN=true

CIM-XML and WSMAN in OpenPegasus use the same ports for HTTP or HTTPS. The default port numbers for HTTP and HTTPS are 5989 and 5989, respectively.

 **NOTE:** You can add these exports at the end of the .bash_profile. This file is located in the /root directory.

- The environment variables will be set when a user logs in using PuTTY.
- On the Linux system itself, for each terminal where the environment variables are not set, run the following command:

```
source /root/.bash_profile
```
- When you logout and login, the environment variables will be set.

Build and install OpenPegasus

From \$PEGASUS_ROOT (the location of the Pegasus source root directory), run the following:

```
make clean
make
make repository
```

 **NOTE:** Whenever OpenPegasus is built from source, all configurations are reset to the default values. If you are rebuilding OpenPegasus, you must redo the configuration as described in [Step 3: Configure OpenPegasus on the Server](#).

Step 2: Start CIM Server on the Server

Use the cimserver command to start CIM server. To stop CIM server, use the command cimserver -s.

To check whether OpenPegasus has been installed properly, enter the following command:

```
cimcli ei -n root/PG_Interop PG_ProviderModule
```

 **NOTE:** For OpenPegasus compiled from source, PEGASUS_HOME must be defined when you start CIM server. Otherwise, CIM server will not load the repository properly. Consider setting PEGASUS_HOME in the ".bash_profile" file.

Step 3: Configure OpenPegasus on the Server

Use the `cimconfig` command to configure OpenPegasus, as shown in the following table:

Command	Description
<code>cimconfig -l</code>	List all valid property names.
<code>cimconfig -l -c</code>	List all valid property names and its value
<code>cimconfig -g <property name></code>	Query a particular property.
<code>cimconfig -s <property name>=<value> -p</code>	Set a particular property.
<code>cimconfig --help</code>	Find out more about the command.

CIM server must be started before running `cimconfig`, and must be restarted for configuration changes to take effect.

Enable Authentication

The following OpenPegasus properties have to be set as described in this section. Otherwise, the Broadcom CIM Provider will not work properly. Ensure the following are set before launching BACS and connecting to the provider.

Start CIM server if it is not already started. Then, set the following:

- `cimconfig -s enableAuthentication=true -p`
- `cimconfig -s enableNamespaceAuthorization=false -p`
- `cimconfig -s httpAuthType=Basic -p`
- `cimconfig -s passwordFilePath=cimserver.passwd -p`
- `cimconfig -s forceProviderProcesses=false -p`

If you want root user to connect remotely:

- `cimconfig -s enableRemotePrivilegedUserAccess=true -p`

User configuration with privilege: The Linux system users are used for OpenPegasus authentication. The systems users have to be added to OpenPegasus using `cimuser` to connect via BACS:

- `cimuser -a -u <username> -w <password>`

Example: `cimuser -a -u root -w linux1`

Enable HTTP

1. If CIM server is not started, start it.
2. Use the following command to set up an HTTP port (optional):

```
cimconfig -s httpPort=5988 -p
```

This property is not available for Inbox OpenPegasus.

3. Use the following command to enable HTTP connection:

```
cimconfig -s enableHttpConnection=true -p
```
4. Use the `cimserver -s` and `cimserver` commands, respectively, to stop and restart CIM server for the new configuration to take effect.

Enable HTTPS

1. If CIM server is not started, start it.
2. Set up HTTPS port with the following command (optional):

```
cimconfig -s httpsPort=5989 -p
```

This property is not available for inbox OpenPegasus.

1. Enable HTTPS connection with 'the following command:
`cimconfig -s enableHttpsConnection=true -p`
2. Use the `cimserver -s` and `cimserver` commands, respectively, to stop and restart CIM server for the new configuration to take effect.

Step 4: Install Broadcom CMPI Provider

Ensure that OpenPegasus is installed properly before installing CMPI Provider.

Install

Enter following command to install Broadcom CMPI Provider.

```
% rpm -i BRCM_CMPIProvider-{version}.{arch}.rpm
```

Uninstall

Enter following command to uninstall Broadcom CMPI Provider:

```
% rpm -e BRCM_CMPIProvider
```

Step 5: Perform Linux Firewall Configuration, If Required

Follow these procedures to open the appropriate ports in the firewall:

RedHat

1. Click **System**, select **Administration**, and then select **Firewall**.
2. Select **Other Ports**.
3. In the Port and Protocol Dialog box, select **User Defined**.
4. In the **Port/Port Range** field, add the port number.
5. In the **Protocol** field, add the protocol as TCP or UDP, etc.
6. Click **Apply** for the firewall rules to take effect.

Example:

- For CIM-XML over HTTP, the port number is 5988 and protocol is TCP.
- For CIM-XML over HTTPS, the port number is 5989 and protocol is TCP.

SuSE

1. Click **Compute** and then click **YaST**.
2. Select **Security & Users** on the left pane.
3. On the right pane, double-click **Firewall**.
4. Select **Custom Rules** on the left pane.
5. On the right pane click **Add**.
6. Enter the following values:
 - **Source Network:** 0/0 (means all)
 - **Protocol:** TCP (or the appropriate protocol)
 - **Destination Port:** <Port Number> or <Range of Port Numbers>
 - **Source Port:** Leave blank.
7. Click **Next** and then click **Finish** for the firewall rules to take effect.

Example:

For CIM-XML, use the following values:

- **Source Network:** 0/0 (means all)
- **Protocol:** TCP
- **Destination Port:** 5988:5989
- **Source Port:** Leave blank.

Step 6: Install BACS and Related Management Applications

See [Installing the Broadcom Advanced Control Suite](#).

Installing WS-MAN or CIM-XML on Linux Client

No special software components are required on the Linux client system to use the HTTP except installing the BACS management application. However, for WS-MAN installations, you can optionally configure the HTTPS protocol for use with BACS.

Configure HTTPS on Linux Client

Import Self-Signed Certificate on Linux Client

On Linux distributions, make note of the following certificate directory:

- For all SuSE versions, the certificate directory is `/etc/ssl/certs`.
- For RedHat, the certificate directory can be different for each version. For some versions, it is `/etc/ssl/certs` or `/etc/pki/tls/certs`. For other versions, find out the certificate directory.

Copy the self-signed certificate file `hostname.pem` into the certificate directory of the Linux client. For example, if the certificate directory is `/etc/ssl/certs`, copy `hostname.pem` to `/etc/ssl/certs`.

1. Change directory to `/etc/ssl/certs`.
2. Create a hash value by running the following command.

```
openssl x509 -noout -hash -in hostname.pem
```

A value such as the following will be returned.

```
100940db
```
3. Create a symbolic link to the hash value by running the following command:

```
ln -s hostname.pem 100940db.0
```

Test HTTPS/SSL Connection from Linux Client

Use the following command to test whether the certificate is installed correctly on Linux:

```
# curl -v --capath /etc/ssl/certs https://Hostname or IPAddress:5986/wsman
```

If this fails, then the certificate is not installed correctly and an error message displays, indicating to take corrective action.

Installing the Broadcom Advanced Control Suite

The Broadcom Advanced Control Suite (BACS) software can be installed on a Linux system using the Linux RPM package. This installation includes a BACS GUI and a CLI client.

Before you begin:

- Ensure that the Broadcom network adapter(s) is physically installed and the appropriate device driver for the NIC is installed on the system to be managed by this utility.
- Ensure that the CIM provider is installed properly on the system that is to be managed by this utility.
- For managing iSCSI on Linux hosts, ensure that the `open-iscsi` and `sg` utilities are installed on the Linux host.

To install BACS

1. Download the latest BACS management application RPM package.
2. Install the RPM package using the following command:

```
% rpm -i BACS-{version}.{arch}.rpm
```

To Use BACS

- To use the GUI, on XWindow, double-click the BACS4 desktop icon, or access the BACS program from the task bar under **System Tools**.
- To use BACS CLI, refer to the file BACSCLI_Readme.txt provided with the release files.

To remove BACS

To uninstall the RPM package, use the following command:

```
% rpm -e BACS
```

[Back to Contents Page](#)

[Back to Contents Page](#)

iSCSI Protocol: Broadcom NetXtreme II® Network Adapter User Guide

- [iSCSI Boot](#)
 - [iSCSI Crash Dump](#)
 - [iSCSI Offload in Windows Server](#)
-

iSCSI Boot

Broadcom NetXtreme II Gigabit Ethernet adapters support iSCSI boot to enable network boot of operating systems to diskless systems. iSCSI boot allows a Windows, Linux, or VMware operating system boot from an iSCSI target machine located remotely over a standard IP network.

For both Windows and Linux operating systems, iSCSI boot can be configured to boot with two distinctive paths: non-offload (also known as Microsoft/Open-iSCSI initiator) and offload (Broadcom's offload iSCSI driver or HBA). Configuration of the path is set with the **HBA Boot Mode** option located on the **General Parameters** screen of the iSCSI Configuration utility. See [Table 1](#) for more information on all **General Parameters** screen configuration options.

Supported Operating Systems for iSCSI Boot

The Broadcom NetXtreme II Gigabit Ethernet adapters support iSCSI boot on the following operating systems:

- Windows Server 2008 and later 32-bit and 64-bit (supports offload and non-offload paths)
- Linux RHEL 5.5 and later, SLES 11.1 and later (supports offload and non-offload paths)
- SLES 10.x and SLES 11 (only supports non-offload path)

iSCSI Boot Setup

The iSCSI boot setup consists of:

- [Configuring the iSCSI Target](#)
- [Configuring iSCSI Boot Parameters](#)
- [Preparing the iSCSI Boot Image](#)
- [Booting](#)

Configuring the iSCSI Target

Configuring the iSCSI target varies by target vendors. For information on configuring the iSCSI target, refer to the documentation provided by the vendor. The general steps include:

1. Create an iSCSI target.
2. Create a virtual disk.
3. Map the virtual disk to the iSCSI target created in step 1.
4. Associate an iSCSI initiator with the iSCSI target.
5. Record the iSCSI target name, TCP port number, iSCSI Logical Unit Number (LUN), initiator Internet Qualified Name (IQN), and CHAP authentication details.
6. After configuring the iSCSI target, obtain the following:
 - Target IQN
 - Target IP address
 - Target TCP port number
 - Target LUN

- o Initiator IQN
- o CHAP ID and secret

Configuring iSCSI Boot Parameters

Configure the Broadcom iSCSI boot software for either static or dynamic configuration. Refer to [Table 1](#) for configuration options available from the General Parameters screen.

[Table 1](#) lists parameters for both IPv4 and IPv6. Parameters specific to either IPv4 or IPv6 are noted.

 NOTE: Availability of IPv6 iSCSI boot is platform/device dependent.

Table 1: Configuration Options

Option	Description
TCP/IP parameters via DHCP	This option is specific to IPv4. Controls whether the iSCSI boot host software acquires the IP address information using DHCP (Enabled) or use a static IP configuration (Disabled).
IP Autoconfiguration	This option is specific to IPv6. Controls whether the iSCSI boot host software will configure a stateless link-local address and/or stateful address if DHCPv6 is present and used (Enabled). Router Solicit packets are sent out up to three times with 4 second intervals in between each retry. Or use a static IP configuration (Disabled).
iSCSI parameters via DHCP	Controls whether the iSCSI boot host software acquires its iSCSI target parameters using DHCP (Enabled) or through a static configuration (Disabled). The static information is entered through the iSCSI Initiator Parameters Configuration screen.
CHAP Authentication	Controls whether the iSCSI boot host software uses CHAP authentication when connecting to the iSCSI target. If CHAP Authentication is enabled, the CHAP ID and CHAP Secret are entered through the iSCSI Initiator Parameters Configuration screen.
DHCP Vendor ID	Controls how the iSCSI boot host software interprets the Vendor Class ID field used during DHCP. If the Vendor Class ID field in the DHCP Offer packet matches the value in the field, the iSCSI boot host software looks into the DHCP Option 43 fields for the required iSCSI boot extensions. If DHCP is disabled, this value does not need to be set.
Link Up Delay Time	Controls how long the iSCSI boot host software waits, in seconds, after an Ethernet link is established before sending any data over the network. The valid values are 0 to 255. As an example, a user may need to set a value for this option if a network protocol, such as Spanning Tree, is enabled on the switch interface to the client system.
Use TCP Timestamp	Controls if the TCP Timestamp option is enabled or disabled.
Target as First HDD	Allows specifying that the iSCSI target drive will appear as the first hard drive in the system.
LUN Busy Retry Count	Controls the number of connection retries the iSCSI Boot initiator will attempt if the iSCSI target LUN is busy.
IP Version	This option specific to IPv6. Toggles between the IPv4 or IPv6 protocol. All IP settings will be lost when switching from one protocol version to another.
HBA Boot Mode	Set to disable when the host OS is configured for software initiator mode and to enable for HBA mode. This option is available on NetXtreme II adapters. (Note: This parameter cannot be changed when the adapter is in Multi-Function mode.)

MBA Boot Protocol Configuration

To configure the boot protocol

1. Restart your system.
2. From the PXE banner, select **CTRL+S**. The MBA Configuration Menu appears (see [Broadcom Boot Agent](#)).
3. From the MBA Configuration Menu, use the **UP ARROW** or **DOWN ARROW** to move to the **Boot Protocol** option. Use the **LEFT ARROW** or **RIGHT ARROW** to change the **Boot Protocol** option to **iSCSI**.

 NOTE: For iSCSI boot-capable LOMs, the boot protocol is set via the BIOS. See your system documentation for more information.

4. Select **iSCSI Boot Configuration** from **Main Menu**.

 **NOTE:** If iSCSI boot firmware is not programmed in the NetXtreme II network adapter, selecting **iSCSI Boot Configuration** will not have any effect.

iSCSI Boot Configuration

- [Static iSCSI Boot Configuration](#)
- [Dynamic iSCSI Boot Configuration](#)

Static iSCSI Boot Configuration

In a static configuration, you must enter data for the system's IP address, the system's initiator IQN, and the target parameters obtained in [Configuring the iSCSI Target](#). For information on configuration options, see [Table 1](#).

To configure the iSCSI boot parameters using static configuration

1. From the **General Parameters Menu** screen, set the following:
 - **TCP/IP parameters via DHCP:** Disabled. (For IPv4.)
 - **IP Autoconfiguration:** Disabled. (For IPv6, non-offload.)
 - **iSCSI parameters via DHCP:** Disabled
 - **CHAP Authentication:** Disabled
 - **DHCP Vendor ID:** BCM ISAN
 - **Link Up Delay Time:** 0
 - **Use TCP Timestamp:** Enabled (for some targets such as the Dell/EMC AX100i, it is necessary to enable **Use TCP Timestamp**)
 - **Target as First HDD:** Disabled
 - **LUN Busy Retry Count:** 0
 - **IP Version:** IPv6. (For IPv6, non-offload.)
 - **HBA Boot Mode:** Disabled (**Note:** This parameter cannot be changed when the adapter is in Multi-Function mode.)
2. Select **ESC** to return to the **Main** menu.
3. From the **Main** menu, select **Initiator Parameters**.
4. From the **Initiator Parameters** screen, type values for the following:
 - IP Address (unspecified IPv4 and IPv6 addresses should be "0.0.0.0" and ":", respectively)
 - Subnet Mask Prefix
 - Default Gateway
 - Primary DNS
 - Secondary DNS
 - iSCSI Name (corresponds to the iSCSI initiator name to be used by the client system)

 **NOTE:** Carefully enter the IP address. There is no error-checking performed against the IP address to check for duplicates or incorrect segment/network assignment.

5. Select **ESC** to return to the **Main** menu.
6. From the **Main** menu, select **1st Target Parameters**.

 **NOTE:** For the initial setup, configuring a second target is not supported.

7. From the **1st Target Parameters** screen, enable **Connect** to connect to the iSCSI target. Type values for the following using the values used when configuring the iSCSI target:
 - IP Address
 - TCP Port
 - Boot LUN
 - iSCSI Name

8. Select **ESC** to return to the **Main** menu.
9. Select **ESC** and select **Exit and Save Configuration**.
10. Select **F4** to save your MBA configuration.

Dynamic iSCSI Boot Configuration

In a dynamic configuration, you only need to specify that the system's IP address and target/initiator information are provided by a DHCP server (see IPv4 and IPv6 configurations in [Configuring the DHCP Server to Support iSCSI Boot](#)). For IPv4, with the exception of the initiator iSCSI name, any settings on the Initiator Parameters, 1st Target Parameters, or 2nd Target Parameters screens are ignored and do not need to be cleared. For IPv6, with the exception of the CHAP ID and Secret, any settings on the Initiator Parameters, 1st Target Parameters, or 2nd Target Parameters screens are ignored and do not need to be cleared. For information on configuration options, see [Table 1](#).

 **NOTE:** When using a DHCP server, the DNS server entries are overwritten by the values provided by the DHCP server. This occurs even if the locally provided values are valid and the DHCP server provides no DNS server information. When the DHCP server provides no DNS server information, both the primary and secondary DNS server values are set to 0.0.0.0. When the Windows OS takes over, the Microsoft iSCSI initiator retrieves the iSCSI Initiator parameters and configures the appropriate registries statically. It will overwrite whatever is configured. Since the DHCP daemon runs in the Windows environment as a user process, all TCP/IP parameters have to be statically configured before the stack comes up in the iSCSI Boot environment.

If DHCP Option 17 is used, the target information is provided by the DHCP server, and the initiator iSCSI name is retrieved from the value programmed from the Initiator Parameters screen. If no value was selected, then the controller defaults to the name:

```
iqn.1995-05.com.broadcom.<11.22.33.44.55.66>.iscsiboot
```

where the string 11.22.33.44.55.66 corresponds to the controller's MAC address.

If DHCP option 43 (IPv4 only) is used, then any settings on the Initiator Parameters, 1st Target Parameters, or 2nd Target Parameters screens are ignored and do not need to be cleared.

To configure the iSCSI boot parameters using dynamic configuration

1. From the **General Parameters Menu** screen, set the following:
 - o **TCP/IP parameters via DHCP:** Enabled. (For IPv4.)
 - o **IP Autoconfiguration:** Enabled. (For IPv6, non-offload.)
 - o **iSCSI parameters via DHCP:** Enabled
 - o **CHAP Authentication:** Disabled
 - o **DHCP Vendor ID:** BCM ISAN
 - o **Link Up Delay Time:** 0
 - o **Use TCP Timestamp:** Enabled (for some targets such as the Dell/EMC AX100i, it is necessary to enable **Use TCP Timestamp**)
 - o **Target as First HDD:** Disabled
 - o **LUN Busy Retry Count:** 0
 - o **IP Version:** IPv6. (For IPv6, non-offload.)
 - o **HBA Boot Mode:** Disabled. (**Note:** This parameter cannot be changed when the adapter is in Multi-Function mode.)
2. Select **ESC** to return to the **Main** menu.

 **NOTE:** Information on the **Initiator Parameters**, and **1st Target Parameters** screens are ignored and do not need to be cleared.

3. Select **Exit and Save Configurations**.

Enabling CHAP Authentication

Ensure that CHAP authentication is enabled on the target.

To enable CHAP authentication

1. From the **General Parameters** screen, set **CHAP Authentication** to Enabled.
2. From the **Initiator Parameters** screen, type values for the following:
 - o CHAP ID (up to 128 bytes)
 - o CHAP Secret (if authentication is required, and must be 12 characters in length or longer)
3. Select **ESC** to return to the **Main** menu.
4. From the **Main** menu, select **1st Target Parameters**.
5. From the **1st Target Parameters** screen, type values for the following using the values used when configuring the iSCSI target:
 - o CHAP ID (optional if two-way CHAP)
 - o CHAP Secret (optional if two-way CHAP, and must be 12 characters in length or longer)
6. Select **ESC** to return to the **Main** menu.
7. Select **ESC** and select **Exit and Save Configuration**.

Configuring the DHCP Server to Support iSCSI Boot

The DHCP server is an optional component and it is only necessary if you will be doing a dynamic iSCSI Boot configuration setup (see [Dynamic iSCSI Boot Configuration](#)).

Configuring the DHCP server to support iSCSI boot is different for IPv4 and IPv6.

- [DHCP iSCSI Boot Configurations for IPv4](#)
- [DHCP iSCSI Boot Configuration for IPv6](#)

DHCP iSCSI Boot Configurations for IPv4

The DHCP protocol includes a number of options that provide configuration information to the DHCP client. For iSCSI boot, Broadcom adapters support the following DHCP configurations:

- [DHCP Option 17, Root Path](#)
- [DHCP Option 43, Vendor-Specific Information](#)

DHCP Option 17, Root Path

Option 17 is used to pass the iSCSI target information to the iSCSI client.

The format of the root path as defined in IETF RFC 4173 is:

```
"iscsi:"<servername>":"<protocol>":"<port>":"<LUN>":"<targetname>"
```

The parameters are defined below.

Table 2: DHCP Option 17 Parameter Definition

Parameter	Definition
"iscsi:"	A literal string
<servername>	The IP address or FQDN of the iSCSI target
":"	Separator
<protocol>	The IP protocol used to access the iSCSI target. Currently, only TCP is supported so the protocol is 6.
<port>	The port number associated with the protocol. The standard port number for iSCSI is 3260.
<LUN>	The Logical Unit Number to use on the iSCSI target. The value of the LUN must be represented in hexadecimal format. A LUN with an ID OF 64 would have to be configured as 40 within the option 17 parameter on the DHCP server.
<targetname>	The target name in either IQN or EUI format (refer to RFC 3720 for details on both IQN and EUI formats). An example IQN name would be "iqn.1995-05.com.broadcom:iscsi-target".

DHCP Option 43, Vendor-Specific Information

DHCP option 43 (vendor-specific information) provides more configuration options to the iSCSI client than DHCP option 17. In this configuration, three additional suboptions are provided that assign the initiator IQN to the iSCSI boot client along with two iSCSI target IQNs that can be used for booting. The format for the iSCSI target IQN is the same as that of DHCP

option 17, while the iSCSI initiator IQN is simply the initiator's IQN.

 **NOTE:** DHCP Option 43 is supported on IPv4 only.

The suboptions are listed below.

Table 3: DHCP Option 43 Suboption Definition

Suboption	Definition
201	First iSCSI target information in the standard root path format "iscsi:"<servername>":"<protocol>":"<port>":"<LUN>":"<targetname>"
203	iSCSI initiator IQN

Using DHCP option 43 requires more configuration than DHCP option 17, but it provides a richer environment and provides more configuration options. Broadcom recommends that customers use DHCP option 43 when performing dynamic iSCSI boot configuration.

Configuring the DHCP Server

Configure the DHCP server to support option 17 or option 43.

 **NOTE:** If using Option 43, you also need to configure Option 60. The value of Option 60 should match the **DHCP Vendor ID** value. The **DHCP Vendor ID** value is BRCM ISAN, as shown in **General Parameters** of the iSCSI Boot Configuration menu.

DHCP iSCSI Boot Configuration for IPv6

The DHCPv6 server can provide a number of options, including stateless or stateful IP configuration, as well s information to the DHCPv6 client. For iSCSI boot, Broadcom adapters support the following DHCP configurations:

- [DHCPv6 Option 16, Vendor Class Option](#)
- [DHCPv6 Option 17, Vendor-Specific Information](#)

 **NOTE:** The DHCPv6 standard Root Path option is not yet available. Broadcom suggests using Option 16 or Option 17 for dynamic iSCSI Boot IPv6 support.

DHCPv6 Option 16, Vendor Class Option

DHCPv6 Option 16 (vendor class option) must be present and must contain a string that matches your configured **DHCP Vendor ID** parameter. The **DHCP Vendor ID** value is BRCM ISAN, as shown in **General Parameters** of the iSCSI Boot Configuration menu.

The content of Option 16 should be <2-byte length> <DHCP Vendor ID>.

DHCPv6 Option 17, Vendor-Specific Information

DHCPv6 Option 17 (vendor-specific information) provides more configuration options to the iSCSI client. In this configuration, three additional suboptions are provided that assign the initiator IQN to the iSCSI boot client along with two iSCSI target IQNs that can be used for booting.

The suboptions are listed below.

Table 4: DHCP Option 17 Suboption Definition

Suboption	Definition
201	First iSCSI target information in the standard root path format "iscsi:"[<servername>]":"<protocol>":"<port>":"<LUN>":"<targetname>"
203	iSCSI initiator IQN

 **NOTE:** In [Table 4](#), the brackets [] are required for the IPv6 addresses.

The content of option 17 should be <2-byte Option Number 201|202|203> <2-byte length> <data>.

Configuring the DHCP Server

Configure the DHCP server to support Option 16 and Option 17.

 NOTE: The format of DHCPv6 Option 16 and Option 17 are fully defined in RFC 3315.

Preparing the iSCSI Boot Image

- [Windows Server 2008 R2 and SP2 iSCSI Boot Setup](#)
- [Windows Server 2012 iSCSI Boot Setup](#)
- [Linux iSCSI Boot Setup](#)
- [Removing Inbox Drivers from Windows 2008/R2 OS Image](#)
- [Removing Inbox Drivers from Windows 2012/R2 OS Image](#)
- [Injecting \(Slipstreaming\) Broadcom Drivers into Windows Image Files](#)

Windows Server 2008 R2 and SP2 iSCSI Boot Setup

Windows Server 2008 R2 and Windows Server 2008 SP2 support booting as well as installing in either the offload or non-offload paths.

The following procedure prepares the image for installation and booting in either the offload or non-offload path. The following procedure references Windows Server 2008 R2 but is common to both the Windows Server 2008 R2 and SP2.

Required CD/ISO image:

- Windows Server 2008 R2 x64 with the Broadcom drivers injected. See [Injecting \(Slipstreaming\) Broadcom Drivers into Windows Image Files](#). Also refer to the Microsoft knowledge base topic KB974072 at support.microsoft.com.

NOTES:

- The Microsoft procedure injects only the eVBD and NDIS drivers. Broadcom recommends that all drivers (eVBD, VBD, BXND, OIS, FCoE, and NetXtreme I NDIS) be injected.
- Refer to the *silent.txt* file for the specific driver installer application for instructions on how to extract the individual Windows NetXtreme II drivers.

Other software required:

- Bindview.exe (Windows Server 2008 R2 only; see KB976042)

Procedure:

1. Remove any local hard drives on the system to be booted (the "remote system").
2. Load the latest Broadcom MBA and iSCSI boot images onto NVRAM of the adapter.
3. Configure the BIOS on the remote system to have the Broadcom MBA as the first bootable device, and the CDROM as the second device.
4. Configure the iSCSI target to allow a connection from the remote device. Ensure that the target has sufficient disk space to hold the new O/S installation.
5. Boot up the remote system. When the Preboot Execution Environment (PXE) banner displays, press **Ctrl+S** to enter the PXE menu.
6. At the PXE menu, set **Boot Protocol** to **iSCSI**.
7. Enter the iSCSI target parameters.
8. Set **HBA Boot Mode** to **Enabled** or **Disabled**. (**Note:** This parameter cannot be changed when the adapter is in Multi-Function mode.)
9. Save the settings and reboot the system.

The remote system should connect to the iSCSI target and then boot from the DVDROM device.

10. Boot to DVD and begin installation.
11. Answer all the installation questions appropriately (specify the Operating System you want to install, accept the license terms, etc.).

When the **Where do you want to install Windows?** window appears, the target drive should be visible. This is a drive connected via the iSCSI boot protocol, located in the remote iSCSI target.

12. Select **Next** to proceed with Windows Server 2008 R2 installation.

A few minutes after the Windows Server 2008 R2 DVD installation process starts, a system reboot will follow. After the reboot, the Windows Server 2008 R2 installation routine should resume and complete the installation.

13. Following another system restart, check and verify that the remote system is able to boot to the desktop.
14. After Windows Server 2008 R2 is booted up, load all drivers and run Bindview.exe.
 - a. Select **All Services**.
 - b. Under **WFP Lightweight Filter** you should see **Binding paths** for the AUT. Right-click and disable them. When done, close out of the application.
15. Verify that the OS and system are functional and can pass traffic by pinging a remote system's IP, etc.

Windows Server 2012 iSCSI Boot Setup

Windows Server 2012 supports booting as well as installing in either the offload or non-offload paths. Broadcom requires the use of a "slipstream" DVD with the latest Broadcom drivers injected. See [Injecting \(Slipstreaming\) Broadcom Drivers into Windows Image Files](#). Also refer to the Microsoft knowledge base topic KB974072 at support.microsoft.com.

 **NOTE:** The Microsoft procedure injects only the eVBD and NDIS drivers. Broadcom recommends that all drivers (eVBD, VBD, BXND, OIS, FCoE, and NetXtreme I NDIS) be injected.

The following procedure prepares the image for installation and booting in either the offload or non-offload path:

1. Remove any local hard drives on the system to be booted (the "remote system").
2. Load the latest Broadcom MBA and iSCSI boot images into the NVRAM of the adapter.
3. Configure the BIOS on the remote system to have the Broadcom MBA as the first bootable device and the CDROM as the second device.
4. Configure the iSCSI target to allow a connection from the remote device. Ensure that the target has sufficient disk space to hold the new O/S installation.
5. Boot up the remote system. When the Preboot Execution Environment (PXE) banner displays, press **Ctrl+S** to enter the PXE menu.
6. At the PXE menu, set **Boot Protocol** to **iSCSI**.
7. Enter the iSCSI target parameters.
8. Set **HBA Boot Mode** to **Enabled** or **Disabled**. (**Note:** This parameter cannot be changed when the adapter is in Multi-Function mode.)
9. Save the settings and reboot the system.

The remote system should connect to the iSCSI target and then boot from the DVDROM device.

10. Boot from DVD and begin installation.
11. Answer all the installation questions appropriately (specify the Operating System you want to install, accept the license terms, etc.).

When the **Where do you want to install Windows?** window appears, the target drive should be visible. This is a drive connected via the iSCSI boot protocol, located in the remote iSCSI target.

12. Select **Next** to proceed with Windows Server 2012 installation.

A few minutes after the Windows Server 2012 DVD installation process starts, a system reboot will occur. After the reboot, the Windows Server 2012 installation routine should resume and complete the installation.

13. Following another system restart, check and verify that the remote system is able to boot to the desktop.
14. After Windows Server 2012 boots to the OS, Broadcom recommends running the driver installer to complete the Broadcom drivers and application installation.

Linux iSCSI Boot Setup

Linux iSCSI boot is supported on Red Hat Enterprise Linux 5.5 and later and SUSE Linux Enterprise Server 11 SP1 and later in both the offload and non-offload paths. Note that SLES 10.x and SLES 11 have support only for the non-offload path.

1. For driver update, obtain the latest Broadcom Linux driver CD.
2. Configure the iSCSI Boot Parameters for DVD direct install to target by disabling the Boot from target option on the network adapter.
3. Configure to install via the non-offload path by setting HBA Boot Mode to **Disabled** in the NVRAM Configuration. (**Note:** This parameter cannot be changed when the adapter is in Multi-Function mode.). Note that, for RHEL6.2 and SLES11SP2 and newer, installation via the offload path is supported. For this case, set the HBA Boot Mode to **Enabled** in the NVRAM Configuration.
4. Change the boot order as follows:
 - a. Boot from the network adapter.
 - b. Boot from the CD/DVD driver.
5. Reboot the system.
6. System will connect to iSCSI target, then will boot from CD/DVD drive.
7. Follow the corresponding OS instructions.
 - a. RHEL 5.5 — Type "linux dd" at "boot:" prompt and press enter
 - b. SuSE 11.X — Choose **installation** and type **withiscsi=1 netsetup=1** at the boot option. If driver update is desired, choose **YES** for the F6 driver option.
8. If driver update is desired, follow the instructions to load the driver CD; otherwise skip this step.
9. At the "networking device" prompt, choose the desired network adapter port and press **OK**.
10. At "configure TCP/IP prompt", configure the way the system acquire IP address and press **OK**.
11. If static IP was chosen, you need to enter IP information for iscsi initiator.
12. (RHEL) Choose to "skip" media testing.
13. Continue installation as desired. A drive will be available at this point. After file copying is done, remove CD/DVD and reboot the system.
14. When the system reboots, enable "boot from target" in iSCSI Boot Parameters and continue with installation until it is done.

At this stage, the initial installation phase is complete. The rest of the procedure pertains to creating a new customized initrd for any new components update:

1. Update iscsi initiator if desired. You will first need to remove the existing initiator using **rpm -e**.
2. Make sure all runlevels of network service are on:

```
chkconfig network on
```
3. Make sure 2,3 and 5 runlevels of iscsi service are on.

```
chkconfig -level 235 iscsi on
```
4. For Red Hat 6.0, make sure Network Manager service is stopped and disabled.
5. Install iscsiui if desired (not required for SuSE 10).
6. Install linux-nx2 package if desired.
7. Install bibt package.
8. Remove ifcfg-eth*.
9. Reboot.
10. For SUSE 11.1, follow the remote DVD installation workaround shown below.
11. After the system reboots, log in, change to the /opt/bcm/bibt folder, and run iscsi_setup.sh script to create the offload and/or the non-offload initrd image.
12. Copy the initrd image(s), offload and/or non-offload, to the /boot folder.
13. Change the grub menu to point to the new initrd image.
14. To enable CHAP, you need to modify iscsid.conf (Red Hat only).
15. Reboot and change CHAP parameters if desired.
16. Continue booting into the iSCSI Boot image and select one of the images you created (non-offload or offload). Your choice should correspond with your choice in the iSCSI Boot parameters section. If HBA Boot Mode was enabled in the

iSCSI Boot Parameters section, you have to boot the offload image. SLES 10.x and SLES 11 do not support offload.

- For IPv6, you can now change the IP address for both the initiator and the target to the desired IPv6 address in the NVRAM configuration.

SUSE 11.1 Remote DVD installation workaround

- Create a new file called boot.open-iscsi with the content shown below.
- Copy the file you just created to /etc/init.d/ folder and overwrite the existing one.

Content of the new boot.open-iscsi file:

```
#!/bin/bash
#
# /etc/init.d/iscsi
#
### BEGIN INIT INFO
# Provides:          iscsiboot
# Required-Start:    boot.multipath
# Should-Start:      boot.multipath
# Required-Stop:
# Should-Stop:       $null
# Default-Start:     B
# Default-Stop:
# Short-Description: iSCSI initiator daemon root-fs support
# Description:        Starts the iSCSI initiator daemon if the
#                    root-filesystem is on an iSCSI device
#
### END INIT INFO
ISCSIADM=/sbin/iscsiadm
ISCSIUIO=/sbin/iscsiuio
CONFIG_FILE=/etc/iscsid.conf
DAEMON=/sbin/iscsid
ARGS="-c $CONFIG_FILE"
# Source LSB init functions
. /etc/rc.status
#
# This service is run right after booting. So all targets activated
# during mkinitrd run should not be removed when the open-iscsi
# service is stopped.
#
iscsi_load_iscsiuio()
{
    TRANSPORT=`$ISCSIADM -m session 2> /dev/null | grep "bnx2i"`
    if [ "$TRANSPORT" ]; then
        echo -n "Launch iscsiuiio "
        startproc $ISCSIUIO
    fi
}
iscsi_mark_root_nodes()
{
    $ISCSIADM -m session 2> /dev/null | while read t num i target ; do
        ip=${i%:*}
        STARTUP=`$ISCSIADM -m node -p $ip -T $target 2> /dev/null | grep "node.conn\[0\].startup" | cut -
d' ' -f3`
        if [ "$STARTUP" -a "$STARTUP" != "onboot" ] ; then
            $ISCSIADM -m node -p $ip -T $target -o update -n node.conn[0].startup -v onboot
        fi
    done
}
# Reset status of this service
rc_reset
# We only need to start this for root on iSCSI
if ! grep -q iscsi_tcp /proc/modules ; then
    if ! grep -q bnx2i /proc/modules ; then
        rc_failed 6
        rc_exit
    fi
fi
case "$1" in
start)
    echo -n "Starting iSCSI initiator for the root device: "
    iscsi_load_iscsiuio
    startproc $DAEMON $ARGS
    rc_status -v
    iscsi_mark_root_nodes
    ;;
stop|restart|reload)
    rc_failed 0
    ;;
status)
    echo -n "Checking for iSCSI initiator service: "
    if checkproc $DAEMON ; then
        rc_status -v
    else
        rc_failed 3
        rc_status -v
    fi
    ;;
*)
    echo "Usage: $0 {start|stop|status|restart|reload}"
    exit 1

```

```
;;
esac
rc_exit
```

Removing Inbox Drivers from Windows 2008/R2 OS Image

1. Create a temporary folder, such as D:\temp.
2. Create the following two subfolders in the temporary folder:
 - o Win2008R2Copy
 - o Win2008R2Mod
3. Copy all the contents from the DVD installation media into the Win2008R2Copy folder.
4. Open the Windows AIK command prompt in elevated mode from All program, and then run the following command:

```
attrib -r D:\Temp\Win2008R2Copy\sources\boot.wim
```
5. Run the following command to mount the boot.wim image:

```
dism /Mount-WIM /WimFile:D:\Temp\Win2008R2Copy\sources\boot.wim /index:1 /MountDir:D:\Temp\Win2008R2Mod
```
6. The Boot.wim image was mounted in the Win2008R2Mod folder. Find all the instances of the files listed below in the subfolders of the Win2008R2Mod folder, and then delete them.

List of files to be deleted.

- o netevbda.inf
- o netevbda.pnf
- o evbda.sys
- o netbxnda.inf
- o netbxnda.pnf
- o bxnd60a.sys
- o bxvbda.sys
- o netbvbda.inf
- o netbvbda.pnf

To easily find all the instances of the files to be deleted, run the following command:

```
dir /s D:\Temp\Win2008R2Mod\filename
```

7. Run the following command to unmount the Boot.wim image:

```
dism /unmount-wim /Mountdir:D:\Temp\Win2008R2Mod /commit
```
8. Repeat steps 5 to 7, but set the index = 2 for the command in step 5.

In this example, index 2 is specified for the standard edition. For other editions, change the index accordingly.

Removing Inbox Drivers from Windows 2012/R2 OS Image

1. Create a temporary folder, such as D:\temp.
2. Create the following two subfolders in the temporary folder:
 - o Win2012R2Copy
 - o Win2012R2Mod
3. Copy all the contents from the DVD installation media into the Win2012R2Copy folder.
4. Open the Windows AIK command prompt in elevated mode from All program, and then run the following command:

```
attrib -r D:\Temp\Win2012R2Copy\sources\boot.wim
```
5. Run the following command to mount the boot.wim image:

```
dism /Mount-WIM /WimFile:D:\Temp\Win2012R2Copy\sources\boot.wim /index:2 /MountDir:D:\Temp\Win2012R2Mod
```



NOTE: You must always use "2" for the index value.

6. The Boot.wim image was mounted in the Win2012R2Mod folder.
7. Delete the files listed below, in the subfolders of the Win2012R2Mod folder.

List of files to be deleted in these two folders.

INFs (e.g. D:\Temp\Win2012R2Mod\Windows\INF)

- o netevbda.inf
- o netbxnda.inf
- o netbvbdada.inf
- o bxfcoe.inf
- o bxois.inf

Drivers (e.g. D:\Temp\Win2012R2Mod\Windows\System32\drivers)

- o bxfcoe.sys
- o bxois.sys
- o bnxcd.sys
- o bnxgcd.sys
- o bxvbdada.sys
- o bxnd60a.sys
- o evbdada.sys

8. Run the following command to unmount the Boot.wim image:

```
dism /unmount-wim /Mountdir:D:\Temp\Win2012R2Mod /commit
```

Injecting (Slipstreaming) Broadcom Drivers into Windows Image Files

To inject Broadcom drivers into the Windows image files, you must obtain the following correct Broadcom driver packages for the applicable Windows Server version (2008R2, 2008SP2, 2012, or 2012R2) from the following location:

http://www.broadcom.com/support/ethernet_nic/netxtremeii10.php

 NOTE: Refer to the *silent.txt* file for the specific driver installer application for instructions on how to extract the individual Windows NetXtreme II drivers.

- EVBDa
- BXND60a
- BXOIS
- BXFCOE

Then, you place these driver packages to a working directory. For example, copy the driver packages to the following directories:

- C:\Temp\evbda
- C:\Temp\bxnd60a
- C:\Temp\bxois
- C:\Temp\bxfcoe

Finally, you inject these drivers into the Windows Image (WIM) files and install the applicable Windows Server version from the updated images.

The detailed steps are provided below:

 NOTE: The file and folder names used in this procedure are examples only. You can specify your own file and folder names for your slipstream project.

1. For Windows Server 2008 R2 and SP2, install the Windows Automated Installation Kit (AIK).
—or—
For Windows Server 2012 and 2012 R2, install the Windows Assessment and Deployment Kit (ADK).
2. Use the following commands to create a temporary directory and set it as the current directory for all later steps:

```
md C:\Temp\x
cd /d C:\Temp\x
```

- Use the following commands to create two subdirectories:

```
md src
md mnt
```

- Use the following command to copy the original DVD into the src subdirectory.

```
xcopy N:\ .\src /e /c /i /f /h /k /y /q
```

Note that in this example, the installation DVD is in the N: drive.

- Open a Deployment and Imaging Tools command prompt in elevated mode. Then, set c:\Temp\x as the current directory.

Note that you will use this command prompt window in all subsequent steps.

- Enter the following commands:

```
attrib -r .\src\sources\boot.wim
attrib -r .\src\sources\install.wim
```

- Enter run the following command to mount the boot.wim image:

```
dism /mount-wim /wimfile:.\src\sources\boot.wim /index:2 /mountdir:.\mnt
```

Note that you must always use "2" for the index value.

- Enter the following commands to add the below drivers to the currently mounted image:

```
dism /image:.\mnt /add-driver /driver:C:\Temp\evbda\evbda.inf
dism /image:.\mnt /add-driver /driver:C:\Temp\bxnd60a\bxnd60a.inf
dism /image:.\mnt /add-driver /driver:C:\Temp\bxfoe\bxfoe.inf
dism /image:.\mnt /add-driver /driver:C:\Temp\bxois\bxois.inf
```

- Enter the following command to unmount the boot.wim image:

```
dism /unmount-wim /mountdir:.\mnt /commit
```

- Enter the following command to determine the index of the desired SKU in the install.wim image:

```
dism /get-wiminfo /wimfile:.\src\sources\install.wim
```

For example, in Windows Server 2012, index 2 is identified as "Windows Server 2012 SERVERSTANDARD."

- Enter the following command to mount the install.wim image:

```
dism /mount-wim /wimfile:.\src\sources\install.wim /index:X /mountdir:.\mnt
```

Note that X is a placeholder for the index value that you obtained in step 10.

- Enter the following commands to add these drivers to the currently mounted image:

```
dism /image:.\mnt /add-driver /driver:C:\Temp\evbd\evbd.inf
dism /image:.\mnt /add-driver /driver:C:\Temp\bxnd60a\bxnd60a.inf
dism /image:.\mnt /add-driver /driver:C:\Temp\bxfoe\bxfoe.inf
dism /image:.\mnt /add-driver /driver:C:\Temp\bxois\bxois.inf
```

- Enter the following command to unmount the install.wim image:

```
dism /unmount-wim /mountdir:.\mnt /commit
```

- Enter the following command to create an .iso file:

```
oscdimg -e -h -m -n -lslipstream -bootdata:2#p0,e,b"c:\Program Files\Windows
AIK\Tools\PETools\amd64\boot\etfsboot.com"#pEF,e,b"c:\Program Files\Windows
AIK\Tools\PETools\amd64\boot\efisys.bin" c:\temp\x\src c:\temp\Win20xxMOD.iso
```

Note that Platform is a placeholder for the architecture of the operating system that you want to install, such as amd64 or x86. Also, xx in the file names is a placeholder for the Windows Server OS version (2012, 2008R2, 2008SP2.)

- Using a DVD-burning application, burn the .iso file you created to a DVD.

- Use the DVD that you created in step 15 to install the applicable Windows Server version.

Booting

After that the system has been prepared for an iSCSI boot and the operating system is present on the iSCSI target, the last step is to perform the actual boot. The system will boot to Windows or Linux over the network and operate as if it were a local disk drive.

- Reboot the server.
- Select **CTRL+S**.
- To boot through an offload path, set the HBA Boot Mode to **Enabled**. To boot through a non-offload path, set the HBA Boot Mode to **Disabled**. (**Note:** This parameter cannot be changed when the adapter is in Multi-Function mode.)

If CHAP authentication is needed, enable CHAP authentication after determining that booting is successful (see [Enabling CHAP Authentication](#)).

Other iSCSI Boot Considerations

There are several other factors that should be considered when configuring a system for iSCSI boot.

Changing the Speed & Duplex Settings in Windows Environments

Changing the Speed & Duplex settings on the boot port using Windows Device Manager when performing iSCSI boot via the offload path is not supported. Booting via the NDIS path is supported. The Speed & Duplex settings can be changed using the BACS management utility for iSCSI boot via the offload and NDIS paths.

Locally Administered Address

A user-defined MAC address assigned through the Locally Administered Address property of the Advanced section of the BACS Configurations tab is not supported on iSCSI boot-enabled devices.

Virtual LANs

Virtual LAN (VLAN) tagging is not supported for iSCSI boot with the Microsoft iSCSI Software Initiator.

The 'dd' method of creating an iSCSI boot image

In the case when installation directly to a remote iSCSI target is not an option, an alternate way to create such an image is to use the 'dd' method. With this method, you install the image directly to a local hard drive and then create an iSCSI boot image for the subsequent boot:

1. Install Linux OS on your local hard drive and ensure that the Open-iSCSI initiator is up to date.
2. Ensure that all Runlevels of network service are on.
3. Ensure that the 2, 3, and 5 Runlevels of iSCSI service are on.
4. Update iscsiui. You can get the iscsiui package from the Broadcom CD. This step is not needed for SuSE 10.
5. Install the linux-nx2 package on your Linux system. You can get this package from Broadcom CD.
6. Install bibt package on you Linux system. You can get this package from Broadcom CD.
7. Delete all ifcfg-eth* files.
8. Configure one port of the network adapter to connect to iSCSI Target (for instructions, see [Configuring the iSCSI Target](#)).
9. Connect to the iSCSI Target.
10. Use the DD command to copy from the local hard drive to iSCSI Target.
11. When DD is done, execute the sync command a couple of times, log out, and then log in to iSCSI Target again.
12. Run the fsck command on all partitions created on the iSCSI Target.
13. Change to the /OPT/bcm/bibt folder and run the iscsi_setup.sh script to create the initrd images. Option 0 will create a non-offload image and option 1 will create an offload image. The Iscsi_script.sh script will create the non-offload image only on SuSE 10 as offload is not supported on SuSE 10.
14. Mount the /boot partition on the iSCSI Target.
15. Copy the initrd images you created in step 13 from your local hard drive to the partition mounted in step 14.
16. On the partition mounted in step 14, edit the grub menu to point to the new initrd images.
17. Unmount the /boot partition on the iSCSI Target.
18. (Red Hat Only) To enable CHAP, you need to modify the CHAP section of the iscsid.conf file on the iSCSI Target. Edit the iscsid.conf file with one-way or two-way CHAP information as desired.
19. Shut down the system and disconnect the local hard drive. Now you are ready to iSCSI boot the iSCSI Target.
20. Configure iSCSI Boot Parameters, including CHAP parameters if desired (see [Configuring the iSCSI Target](#)).
21. Continue booting into the iSCSI Boot image and choose one of the images you created (non-offload or offload). Your choice should correspond with your choice in the iSCSI Boot parameters section. If HBA Boot Mode was enabled in the

iSCSI Boot Parameters section, you have to boot the offload image. SuSE 10.x and SLES 11 do not support offload.

Troubleshooting iSCSI Boot

The following troubleshooting tips are useful for iSCSI boot.

Problem: A system blue screen occurs when iSCSI boots Windows Server 2008 R2 through the adapter's NDIS path with the initiator configured using a link-local IPv6 address and the target configured using a router-configured IPv6 address.

Solution: This is a known Windows TCP/IP stack issue.

Problem: The Broadcom iSCSI Crash Dump utility will not work properly to capture a memory dump when the link speed for iSCSI boot is configured for 10 Mbps or 100 Mbps.

Solution: The iSCSI Crash Dump utility is supported when the link speed for iSCSI boot is configured for 1 Gbps or 10 Gbps. 10 Mbps or 100 Mbps is not supported.

Problem: An iSCSI target is not recognized as an installation target when you try to install Windows Server 2008 by using an IPv6 connection.

Solution: This is a known third-party issue. See Microsoft Knowledge Base KB 971443,

<http://support.microsoft.com/kb/971443>.

Problem: When switching iSCSI boot from the Microsoft standard path to Broadcom iSCSI offload, the booting fails to complete.

Solution: Install or upgrade the Broadcom Virtual Bus Device (VBD) driver to 5.0.x, along with the OIS driver, prior to switching the iSCSI boot path.

Problem: The iSCSI configuration utility will not run.

Solution: Ensure that the iSCSI Boot firmware is installed in the NVRAM.

Problem: A system blue screen occurs when installing the Broadcom drivers through Windows Plug-and-Play (PnP).

Solution: Install the drivers through the Setup installer.

Problem: For static IP configuration when switching from Layer 2 iSCSI boot to Broadcom iSCSI HBA, then you will receive an IP address conflict.

Solution: Change the IP address of the network property in the OS.

Problem: After configuring the iSCSI boot LUN to 255, a system blue screen appears when performing iSCSI boot.

Solution: Although Broadcom's iSCSI solution supports a LUN range from 0 to 255, the Microsoft iSCSI software initiator does not support a LUN of 255. Configure a LUN value from 0 to 254.

Problem: NDIS miniports with Code 31 yellow-bang after L2 iSCSI boot install.

Solution: Run the T7.4 installer.

Problem: Unable to update inbox driver if a non-inbox hardware ID present.

Solution: Create a custom slipstream DVD image with supported drivers present on the install media.

Problem: In Windows Server 2012, toggling between iSCSI HBA offload mode and iSCSI software initiator boot can leave the machine in a state where the HBA offload miniport bxois will not load.

Solution: Manually edit [HKEY_LOCAL_MACHINE\SYSTEM\CurrentControlSet\Services\bxois\StartOverride] from 3 to 0.

Modify the registry key before toggling back from NDIS to HBA path in CCM.



NOTE: Microsoft recommends against this method. **Toggling the boot path from NDIS to HBA or vice versa after installation is completed is not recommended.**

Problem: The Xen hypervisor will not start when booting from an iSCSI image created with the RHEL 5.4 Xen kernel.

Solution: This is a known third-party issue. To work around this issue, disable the Xen hypervisor's EDD feature by editing the grub.conf file in the boot/grub folder to add the `edd=off` switch to the end of the kernel line. For example,

```
kernel /xen.gz edd=off.
```

Problem: Unable to connect to an EqualLogic target using Windows Server 2008 and higher.

Solution: Add an exception to your firewall to allow ICMP echo requests.

Problem: Installing Windows onto an iSCSI target via iSCSI boot fails when connecting to a 1 Gbps switch port.

Solution: This is a limitation relating to adapters that use SFP+ as the physical connection. SFP+ defaults to 10 Gbps operation and does not support autonegotiation.

Problem: SLES 11 SP3 - iSCSI remote installation on 1 Gbps port of the 57800 NIC adapter fails with inbox driver. Loading the external driver does not unload inbox bnx2x driver as well.

Solution: Enter or append the following syntax `bnx2x.num_vfs=0` in the command prompt at the initial installation in order to prevent the inbox bnx2x driver from loading. Example: at step 7b in the [Linux iSCSI Boot Setup](#) section, enter:
`withiscsi=1 netsetup=1 bnx2x.num_vfs=0`

iSCSI Crash Dump

If you will use the Broadcom iSCSI Crash Dump utility, it is important to follow the installation procedure to install the iSCSI Crash Dump driver. See [Using the Installer](#) for more information.

iSCSI Offload in Windows Server

iSCSI traffic may be segregated offload is a technology that offloads iSCSI protocol processing overhead from host processors to the iSCSI host bus adapter to increase network performance and throughput while helping to optimize server processor utilization.

This section covers Broadcom's iSCSI offload feature for the NetXtreme II family of network adapters on Windows Server systems. For Linux iSCSI offload, see [Linux iSCSI Offload](#).

iSCSI Offload Limitations

The bnx2i driver for iSCSI does not operate on a stand-alone PCI device. It shares the same PCI device with the networking driver (bnx2 and bnx2x). The networking driver alone supports layer 2 networking traffic. Offloaded iSCSI operations require both the networking driver and the bnx2i driver.

iSCSI operations will be interrupted when the networking driver brings down or resets the device. This scenario requires proper handling by the networking and bnx2i drivers, as well as the userspace `iscsid` daemon that keeps track of all iSCSI sessions. Offloaded iSCSI connections take up system and on-chip resources that must be freed up before the device can be reset. `iscsid` running in userspace is generally less predictable, as it can run slowly and take a long time to disconnect and reconnect iSCSI sessions during network reset, especially when the number of connections is large. Broadcom cannot guarantee that iSCSI sessions will always recover in every conceivable scenario when the networking device is repeatedly being reset. Broadcom recommends that administrator-administered network device resets, such as MTU change, ring size change, device shutdown, hot-unplug, and so forth, be kept at a minimum while there are active offloaded iSCSI sessions running on that shared device. On the other hand, link-related changes do not require device reset and are safe to be performed at any time.

To help alleviate some of the above issues, install the latest open-iscsi utilities by upgrading your Red Hat Network subscription.

Configuring iSCSI Offload

With the proper iSCSI offload licensing, you can configure your iSCSI-capable NetXtreme II network adapter to offload iSCSI processing from the host processor. The following process enables your system to take advantage of Broadcom's iSCSI offload feature.

- [Installing Broadcom Drivers and Management Applications](#)
- [Installing the Microsoft iSCSI Initiator](#)
- [Configuring Broadcom iSCSI Using BACS](#)
- [Configure Microsoft Initiator to Use Broadcom's iSCSI Offload](#)

Installing Broadcom Drivers and Management Applications

Install the Windows drivers and management applications. See [Installing Windows Drivers and Management Applications](#).

Installing the Microsoft iSCSI Initiator

For Windows Server 2008 and later, the iSCSI initiator is included in the inbox. To download the iSCSI initiator from Microsoft, go to <http://www.microsoft.com/en-us/download/details.aspx?displaylang=en&id=18986> and locate the direct link for your system.

Configuring Broadcom iSCSI Using BACS

The Broadcom Advanced Control Suite (BACS) is used to manage all of Broadcom's network adapters and advanced features. For more information, see [Using Broadcom Advanced Control Suite 4](#).

1. Open BACS.
2. Select the Broadcom NetXtreme II C-NIC iSCSI adapter. If the C-NIC iSCSI adapter is not present, then select the VBD device and enable iSCSI offload by selecting **iSCSI Offload Engine** from the **Resource Reservations** area of the Configuration tab. See [Viewing and Configuring Resource Reservations](#).
3. Select the Configuration tab.
4. DHCP is the default for IP address assignment, but this can be changed to static IP address assignment, if this is the preferred method of IP address assignment.

 NOTE: The IP address assignment method cannot be changed if the adapter was used for boot.

5. Select **Apply** and close BACS.

Configure Microsoft Initiator to Use Broadcom's iSCSI Offload

Now that the IP address has been configured for the iSCSI adapter, you need to use Microsoft Initiator to configure and add a connection to the iSCSI target using Broadcom iSCSI adapter. See Microsoft's user guide for more details on Microsoft Initiator.

1. Open Microsoft Initiator.
2. Configure the initiator IQN name according to your setup. To change, click on **Change**.

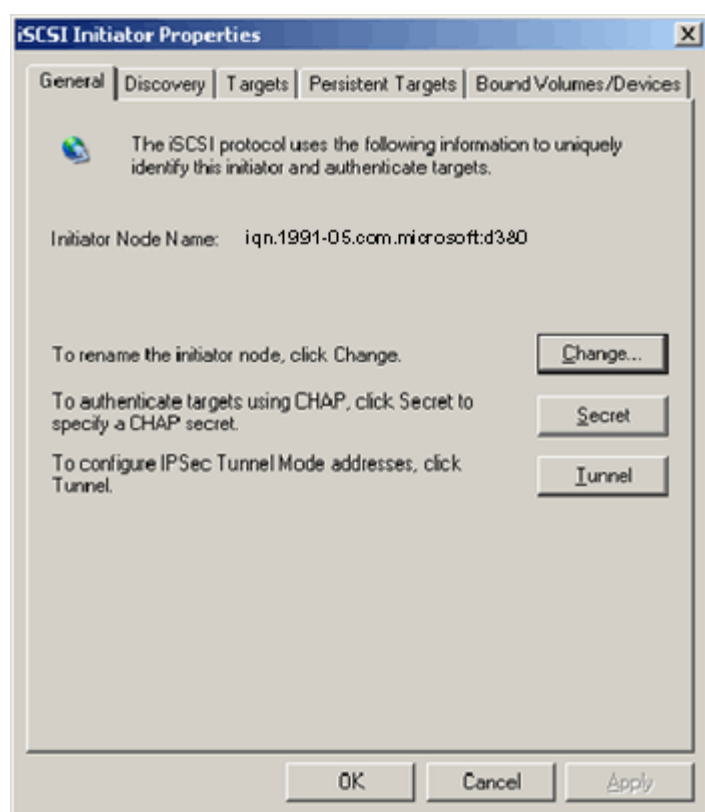

3. Enter the initiator IQN name.

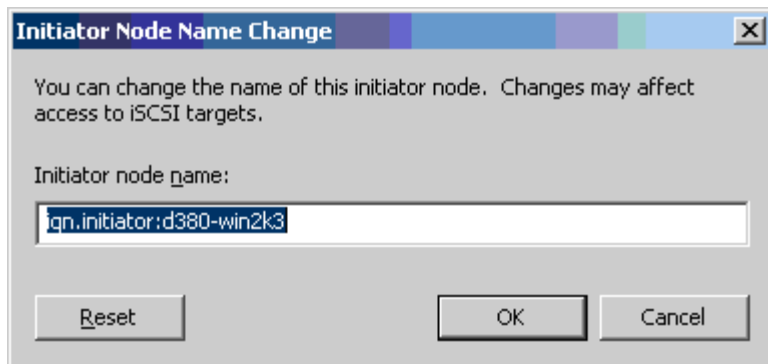

4. Select the Discovery tab and click **Add** to add a target portal.

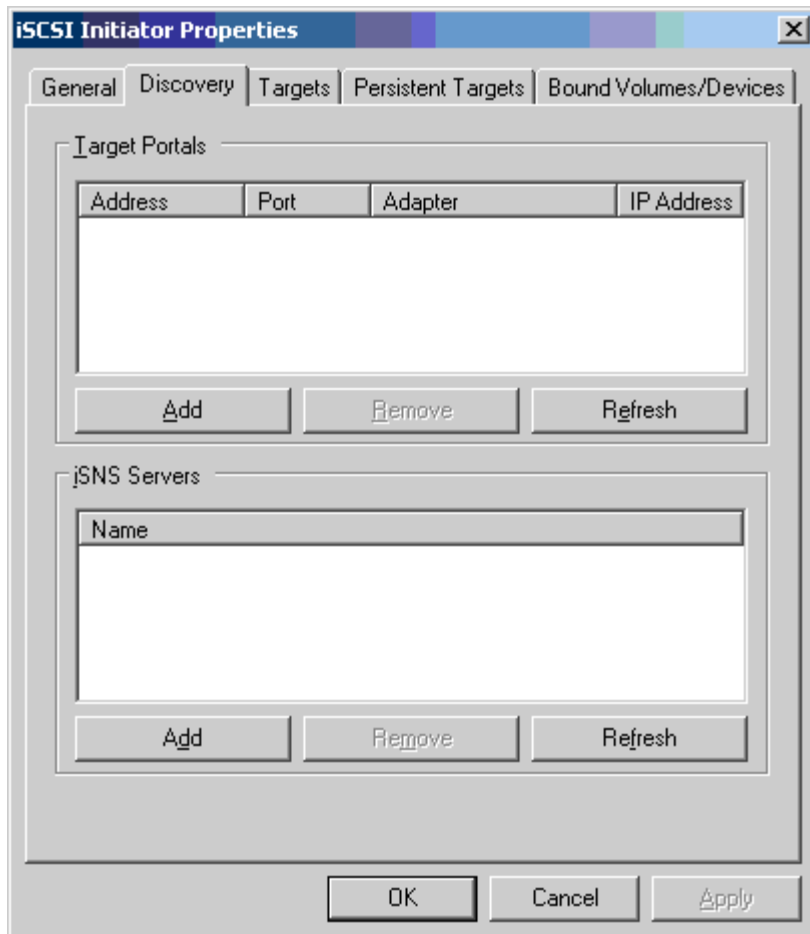

5. Enter the IP address of the target and click **Advanced**.

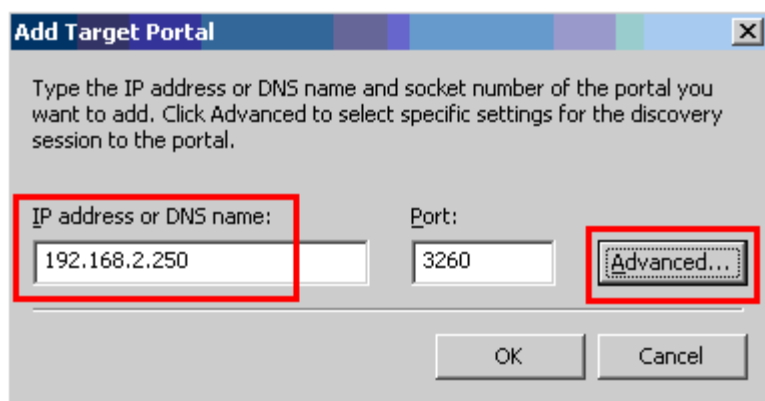

- From the General tab, select Broadcom NetXtreme II C-NIC iSCSI Adapter from **Local adapter**.

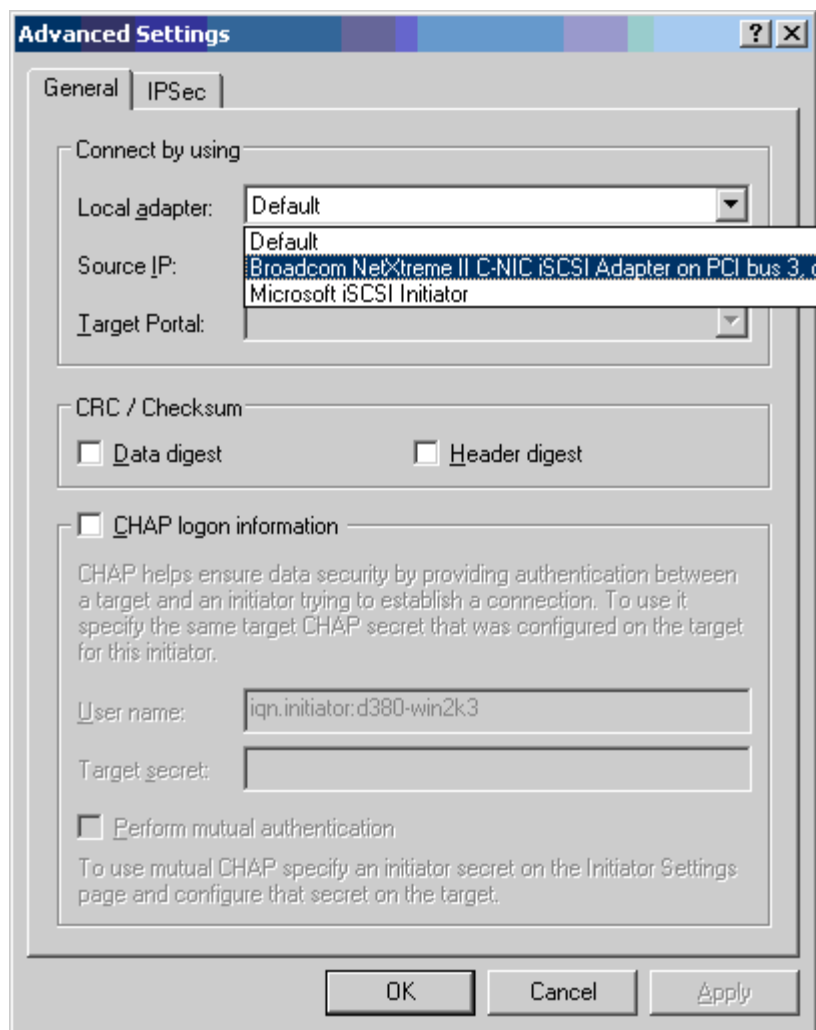

- Select the IP address for the adapter from **Source IP**.

The image shows a Windows-style dialog box titled "Advanced Settings" with two tabs: "General" and "IPSec". The "General" tab is active. It contains several sections:

- Connect by using:** A group box containing three dropdown menus:
 - Local adapter: "Broadcom NetXtreme II C-NIC iSCSI Adapter on f"
 - Source IP: "Default"
 - Target Portal: "Default" (with "192.168.1.1" listed below it)
- CRC / Checksum:** Two checkboxes: "Data digest" and "Header digest", both are unchecked.
- CHAP logon information:** A section with a title bar and a checkbox "CHAP logon information" which is unchecked. Below the title bar is explanatory text: "CHAP helps ensure data security by providing authentication between a target and an initiator trying to establish a connection. To use it specify the same target CHAP secret that was configured on the target for this initiator." Below this text are two text input fields:
 - User name: "iqn.initiator:d380-win2k3"
 - Target secret: (empty)
- Perform mutual authentication:** A checkbox which is unchecked. Below it is explanatory text: "To use mutual CHAP specify an initiator secret on the Initiator Settings page and configure that secret on the target."

At the bottom of the dialog are three buttons: "OK", "Cancel", and "Apply".

8. Click **OK** to close Advanced setting and then **OK** to add the target portal.

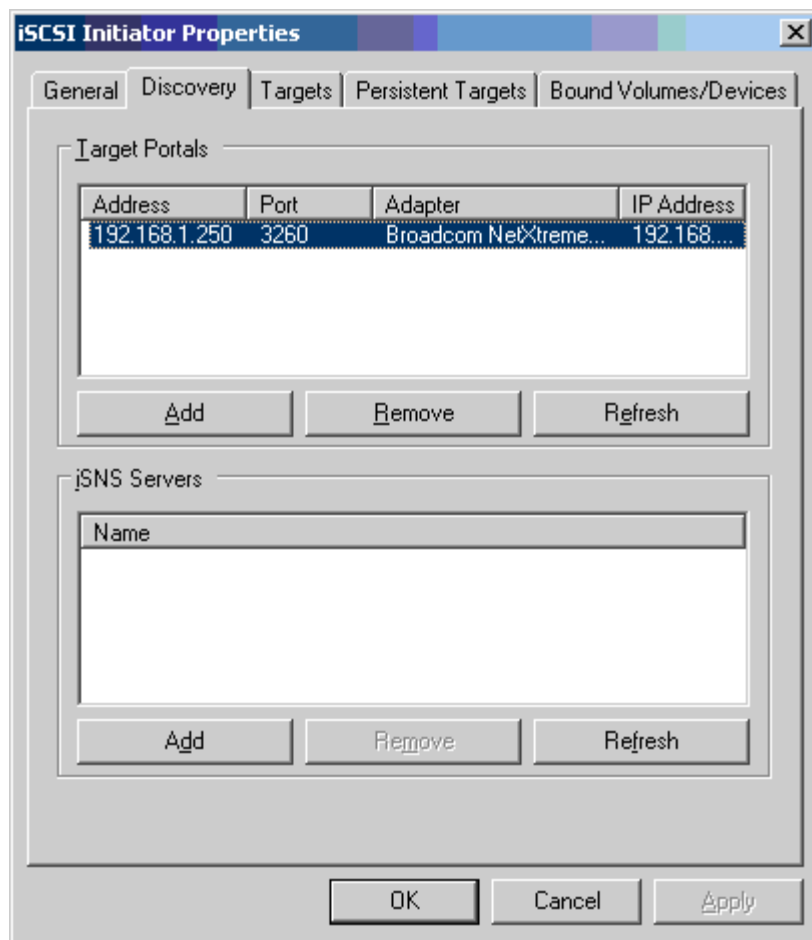

9. From the Targets tab, select the target and click **Log On** to log into your iSCSI target using the Broadcom iSCSI adapter.

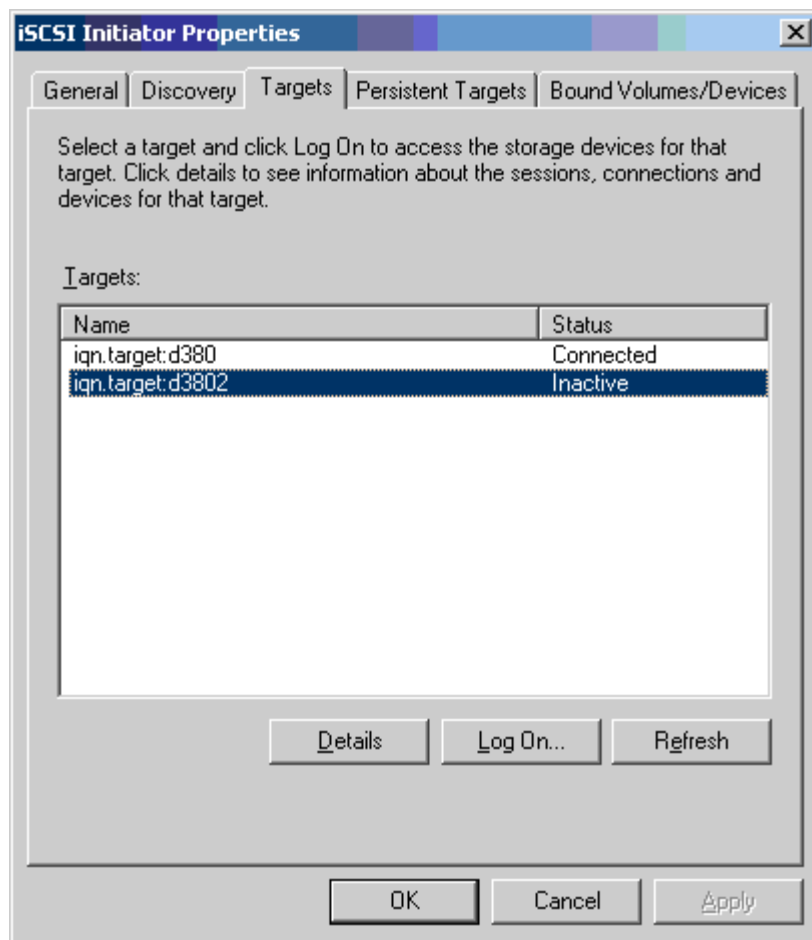

- Click on **Advanced**.

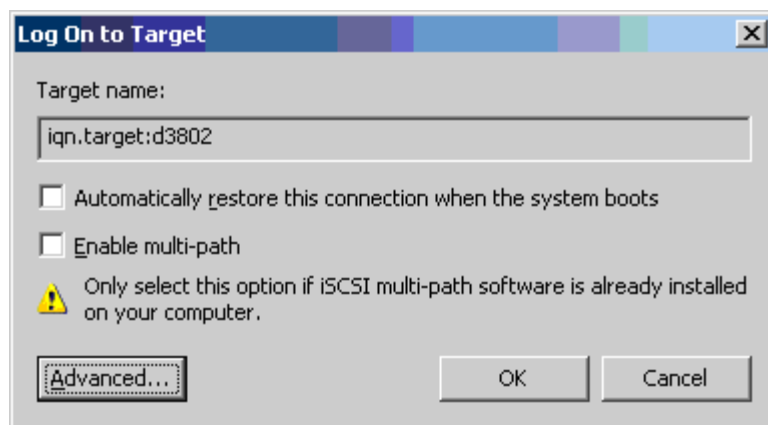

- On the General tab, select the Broadcom NetXtreme II C-NIC iSCSI adapter from **Local adapter**.
- Click **OK** to close Advanced settings.

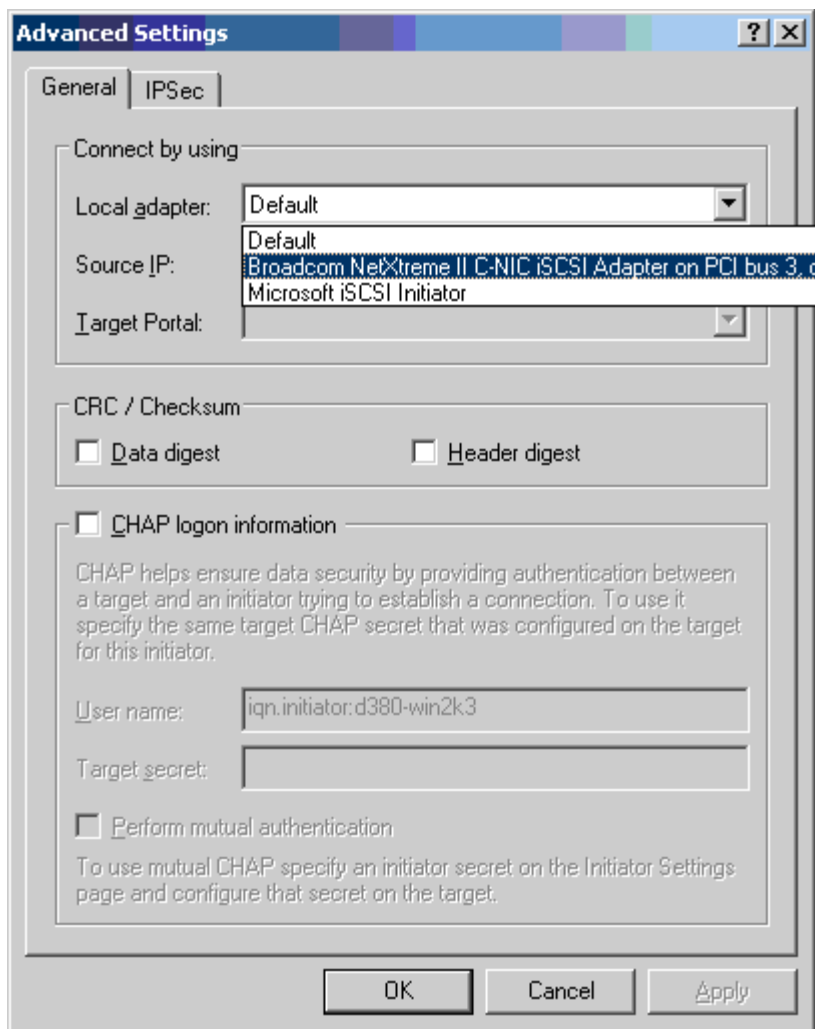

13. Click **OK** to close the Microsoft Initiator.
14. To format your iSCSI partition, use Disk Manager.

NOTES:

- o Teaming does not support iSCSI adapters.
- o Teaming does not support NDIS adapters that are in the boot path.
- o Teaming supports NDIS adapters that are not in the iSCSI boot path, but only for the SLB team type.

iSCSI Offload FAQs

Q: How do I assign an IP address for iSCSI offload?

A: Use the Configurations tab in Broadcom Advanced Control Suite (BACS).

Q: What tools should be used to create the connection to the target?

A: Use Microsoft iSCSI Software Initiator (version 2.08 or later).

Q: How do I know that the connection is offloaded?

A: Use Microsoft iSCSI Software Initiator. From a command line, type `iscsicli sessionlist`. From **Initiator Name**, an iSCSI offloaded connection will display an entry beginning with "B06BDRV...". A non-offloaded connection will display an entry beginning with "Root...".

Q: What configurations should be avoided?

A: The IP address should not be the same as the LAN.

Q: Why does the install fail when attempting to complete an iSCSI offload install using Windows Server 2008 R2 for BCM5709 (1 GbE) adapters?

A: There is a conflict with the internal inbox driver.

Event Log Messages

Table 5 lists the offload iSCSI driver event log messages.

Offload iSCSI (OIS) Driver

Table 5: Offload iSCSI (OIS) Driver Event Log Messages

Message Number	Severity	Message
1	Error	Initiator failed to connect to the target. Target IP address and TCP Port number are given in dump data.
2	Error	The initiator could not allocate resources for an iSCSI session.
3	Error	Maximum command sequence number is not serially greater than expected command sequence number in login response. Dump data contains Expected Command Sequence number followed by Maximum Command Sequence number.
4	Error	MaxBurstLength is not serially greater than FirstBurstLength. Dump data contains FirstBurstLength followed by MaxBurstLength.
5	Error	Failed to setup initiator portal. Error status is given in the dump data.
6	Error	The initiator could not allocate resources for an iSCSI connection
7	Error	The initiator could not send an iSCSI PDU. Error status is given in the dump data.
8	Error	Target or discovery service did not respond in time for an iSCSI request sent by the initiator. iSCSI Function code is given in the dump data. For details about iSCSI Function code please refer to iSCSI User's Guide.
9	Error	Target did not respond in time for a SCSI request. The CDB is given in the dump data.
10	Error	Login request failed. The login response packet is given in the dump data.
11	Error	Target returned an invalid login response packet. The login response packet is given in the dump data.
12	Error	Target provided invalid data for login redirect. Dump data contains the data returned by the target.
13	Error	Target offered an unknown AuthMethod. Dump data contains the data returned by the target.
14	Error	Target offered an unknown digest algorithm for CHAP. Dump data contains the data returned by the target.
15	Error	CHAP challenge given by the target contains invalid characters. Dump data contains the challenge given.
16	Error	An invalid key was received during CHAP negotiation. The key=value pair is given in the dump data.
17	Error	CHAP Response given by the target did not match the expected one. Dump data contains the CHAP response.
18	Error	Header Digest is required by the initiator, but target did not offer it.
19	Error	Data Digest is required by the initiator, but target did not offer it.
20	Error	Connection to the target was lost. The initiator will attempt to retry the connection.
21	Error	Data Segment Length given in the header exceeds MaxRecvDataSegmentLength declared by the target.
22	Error	Header digest error was detected for the given PDU. Dump data contains the header and digest.
23	Error	Target sent an invalid iSCSI PDU. Dump data contains the entire iSCSI header.
24	Error	Target sent an iSCSI PDU with an invalid opcode. Dump data contains the entire iSCSI header.
25	Error	Data digest error was detected. Dump data contains the calculated checksum followed by the given checksum.
26	Error	Target trying to send more data than requested by the initiator.
27	Error	Initiator could not find a match for the initiator task tag in the received PDU. Dump data contains the entire iSCSI header.
28	Error	Initiator received an invalid R2T packet. Dump data contains the entire iSCSI header.
29	Error	Target rejected an iSCSI PDU sent by the initiator. Dump data contains the rejected PDU.
30	Error	Initiator could not allocate a work item for processing a request.
31	Error	Initiator could not allocate resource for processing a request.

32	Information	Initiator received an asynchronous logout message. The Target name is given in the dump data.
33	Error	Challenge size given by the target exceeds the maximum specified in iSCSI specification.
34	Information	A connection to the target was lost, but Initiator successfully reconnected to the target. Dump data contains the target name.
35	Error	Target CHAP secret is smaller than the minimum size (12 bytes) required by the specification.
36	Error	Initiator CHAP secret is smaller than the minimum size (12 bytes) required by the specification. Dump data contains the given CHAP secret.
37	Error	FIPS service could not be initialized. Persistent logons will not be processed.
38	Error	Initiator requires CHAP for logon authentication, but target did not offer CHAP.
39	Error	Initiator sent a task management command to reset the target. The target name is given in the dump data.
40	Error	Target requires logon authentication via CHAP, but Initiator is not configured to perform CHAP.
41	Error	Target did not send AuthMethod key during security negotiation phase.
42	Error	Target sent an invalid status sequence number for a connection. Dump data contains Expected Status Sequence number followed by the given status sequence number.
43	Error	Target failed to respond in time for a login request.
44	Error	Target failed to respond in time for a logout request.
45	Error	Target failed to respond in time for a login request. This login request was for adding a new connection to a session.
46	Error	Target failed to respond in time for a SendTargets command.
47	Error	Target failed to respond in time for a SCSI command sent through a WMI request.
48	Error	Target failed to respond in time to a NOP request.
49	Error	Target failed to respond in time to a Task Management request.
50	Error	Target failed to respond in time to a Text Command sent to renegotiate iSCSI parameters.
51	Error	Target failed to respond in time to a logout request sent in response to an asynchronous message from the target.
52	Error	Initiator Service failed to respond in time to a request to configure IPsec resources for an iSCSI connection.
53	Error	Initiator Service failed to respond in time to a request to release IPsec resources allocated for an iSCSI connection.
54	Error	Initiator Service failed to respond in time to a request to encrypt or decrypt data.
55	Error	Initiator failed to allocate resources to send data to target.
56	Error	Initiator could not map an user virtual address to kernel virtual address resulting in I/O failure.
57	Error	Initiator could not allocate required resources for processing a request resulting in I/O failure.
58	Error	Initiator could not allocate a tag for processing a request resulting in I/O failure.
59	Error	Target dropped the connection before the initiator could transition to Full Feature Phase.
60	Error	Target sent data in SCSI Response PDU instead of Data_IN PDU. Only Sense Data can be sent in SCSI Response.
61	Error	Target set DataPduInOrder to NO when initiator requested YES. Login will be failed.
62	Error	Target set DataSequenceInOrder to NO when initiator requested YES. Login will be failed.
63	Error	Cannot reset the target or LUN. Will attempt session recovery.
64	Information	Attempt to bootstrap Windows using iSCSI NIC Boot (iBF).
65	Error	Booting from iSCSI, but could not set any NIC in Paging Path.
66	Error	Attempt to disable the Nagle Algorithm for iSCSI connection failed.
67	Information	If Digest support selected for iSCSI Session, will use Processor support for Digest computation.
68	Error	After receiving an async logout from the target, attempt to relogin the session failed. Error status is given in the dump data.
69	Error	Attempt to recover an unexpected terminated session failed. Error status is given in the dump data.
70	Error	Error occurred when processing iSCSI logon request. The request was not retried. Error status is given in the dump data.
71	Information	Initiator did not start a session recovery upon receiving the request. Dump data contains the error status.

72	Error	Unexpected target portal IP types. Dump data contains the expected IP type.
----	-------	---

Please read all [Restrictions and Disclaimers](#).

[Back to Contents Page](#)

[Back to Contents Page](#)

Broadcom Teaming Services: Broadcom NetXtreme II® Network Adapter User Guide

 **NOTE:** This chapter describes teaming for adapters in Windows Server systems. For more information on a similar technologies on other operating systems (for example, Linux Channel Bonding), refer to your operating system documentation.

- [Executive Summary](#)
- [Teaming Mechanisms](#)
- [Teaming and Other Advanced Networking Properties](#)
- [General Network Considerations](#)
- [Application Considerations](#)
- [Troubleshooting Teaming Problems](#)
- [Frequently Asked Questions](#)
- [Appendix A: Event Log Messages](#)

Executive Summary

- [Glossary](#)
- [Teaming Concepts](#)
- [Software Components](#)
- [Hardware Requirements](#)
- [Teaming Support by Processor](#)
- [Configuring Teaming](#)
- [Supported Features by Team Type](#)
- [Selecting a Team Type](#)

This section describes the technology and implementation considerations when working with the network teaming services offered by the Broadcom software shipped with Dell's servers and storage products. The goal of Broadcom teaming services is to provide fault tolerance and link aggregation across a team of two or more adapters. The information in this document is provided to assist IT professionals during the deployment and troubleshooting of system applications that require network fault tolerance and load balancing.

Glossary

Table 1: Glossary

Item	Definition
ARP	Address Resolution Protocol
BACS	Broadcom Advanced Control Suite
BASP	Broadcom Advanced Server Program (intermediate driver)
DNS	domain name service
G-ARP	Gratuitous Address Resolution Protocol
Generic Trunking (FEC/GEC)/802.3ad-Draft Static	Switch-dependent load balancing and failover type of team in which the intermediate driver manages outgoing traffic and the switch manages incoming traffic.

HSRP	Hot Standby Router Protocol
ICMP	Internet Control Message Protocol
IGMP	Internet Group Management Protocol
IP	Internet Protocol
IPv6	Version 6 of the IP Protocol
iSCSI	Internet Small Computer Systems Interface
L2	Layer 2. Used to describe network traffic that is not offloaded, and where hardware only performs Layer 2 operations on the traffic. Layer 3 (IP) and Layer 4 (TCP) protocols are processed in software.
L4	Layer 4. Used to describe network traffic that is heavily offloaded to the hardware, where much of the Layer 3 (IP) and Layer 4 (TCP) processing is done in the hardware to improve performance.
LACP	Link Aggregation Control Protocol
Link Aggregation (802.3ad)	Switch-dependent load balancing and failover type of team with LACP in which the intermediate driver manages outgoing traffic and the switch manages incoming traffic.
LOM	LAN on Motherboard
MAC	media access control
NDIS	Network Driver Interface Specification
NLB	Network Load Balancing (Microsoft)
PXE	Preboot Execution Environment
RAID	redundant array of inexpensive disks
Smart Load Balancing™ and Failover	Switch-independent failover type of team in which the primary team member handles all incoming and outgoing traffic while the standby team member is idle until a failover event (for example, loss of link occurs). The intermediate driver (BASP) manages incoming/outgoing traffic.
Smart Load Balancing (SLB)	Switch-independent load balancing and failover type of team, in which the intermediate driver manages outgoing/incoming traffic.
TCP	Transmission Control Protocol
TOE	TCP Offload Engine. This is the hardware that is capable of handling stateful fastpath offloading of TCP and IP processing.
UDP	User Datagram Protocol
WINS	Windows name service
WLBS	Windows Load Balancing Service

Teaming Concepts

- [Network Addressing](#)
- [Teaming and Network Addresses](#)
- [Description of Teaming Types](#)
- [TOE Teaming](#)

The concept of grouping multiple physical devices to provide fault tolerance and load balancing is not new. It has been around for years. Storage devices use RAID technology to group individual hard drives. Switch ports can be grouped together using technologies such as Cisco Gigabit EtherChannel, IEEE 802.3ad Link Aggregation, Bay Network Multilink Trunking, and Extreme Network Load Sharing. Network interfaces on Dell servers can be grouped together into a team of physical ports called a virtual adapter.

Network Addressing

To understand how teaming works, it is important to understand how node communications work in an Ethernet network. This document is based on the assumption that the reader is familiar with the basics of IP and Ethernet network communications. The following information provides a high-level overview of the concepts of network addressing used in an Ethernet network. Every Ethernet network interface in a host platform, such as a computer system, requires a globally unique Layer 2 address and at least one globally unique Layer 3 address. Layer 2 is the Data Link Layer, and Layer 3 is the Network layer as defined in the OSI model. The Layer 2 address is assigned to the hardware and is often referred to as the MAC address or physical address. This address is pre-programmed at the factory and stored in NVRAM on a network interface card or on the system motherboard for an embedded LAN interface. The Layer 3 addresses are referred to as the protocol or logical address

assigned to the software stack. IP and IPX are examples of Layer 3 protocols. In addition, Layer 4 (Transport Layer) uses port numbers for each network upper level protocol such as Telnet or FTP. These port numbers are used to differentiate traffic flows across applications. Layer 4 protocols such as TCP or UDP are most commonly used in today's networks. The combination of the IP address and the TCP port number is called a socket.

Ethernet devices communicate with other Ethernet devices using the MAC address, not the IP address. However, most applications work with a host name that is translated to an IP address by a Naming Service such as WINS and DNS. Therefore, a method of identifying the MAC address assigned to the IP address is required. The Address Resolution Protocol for an IP network provides this mechanism. For IPX, the MAC address is part of the network address and ARP is not required. ARP is implemented using an ARP Request and ARP Reply frame. ARP Requests are typically sent to a broadcast address while the ARP Reply is typically sent as unicast traffic. A unicast address corresponds to a single MAC address or a single IP address. A broadcast address is sent to all devices on a network.

Teaming and Network Addresses

A team of adapters function as a single virtual network interface and does not appear any different to other network devices than a non-teamed adapter. A virtual network adapter advertises a single Layer 2 and one or more Layer 3 addresses. When the teaming driver initializes, it selects one MAC address from one of the physical adapters that make up the team to be the Team MAC address. This address is typically taken from the first adapter that gets initialized by the driver. When the system hosting the team receives an ARP request, it selects one MAC address from among the physical adapters in the team to use as the source MAC address in the ARP Reply. In Windows operating systems, the IPCONFIG /all command shows the IP and MAC address of the virtual adapter and not the individual physical adapters. The protocol IP address is assigned to the virtual network interface and not to the individual physical adapters.

For switch-independent teaming modes, all physical adapters that make up a virtual adapter must use the unique MAC address assigned to them when transmitting data. That is, the frames that are sent by each of the physical adapters in the team must use a unique MAC address to be IEEE compliant. It is important to note that ARP cache entries are not learned from received frames, but only from ARP requests and ARP replies.

Description of Teaming Types

- Smart Load Balancing and Failover
- Generic Trunking
- Link Aggregation (IEEE 802.3ad LACP)
- SLB (Auto-Fallback Disable)

There are three methods for classifying the supported teaming types:

- One is based on whether the switch port configuration must also match the adapter teaming type.
- The second is based on the functionality of the team, whether it supports load balancing and failover or just failover.
- The third is based on whether the Link Aggregation Control Protocol is used or not.

Table 2 shows a summary of the teaming types and their classification.

Table 2: Available Teaming Types

Teaming Type	Switch-Dependent (Switch must support specific type of team)	Link Aggregation Control Protocol Support Required on the Switch	Load Balancing	Failover
Smart Load Balancing and Failover (with two to eight load balance team members)			✓	✓
SLB (Auto-Fallback Disable)			✓	✓
Link Aggregation (802.3ad)	✓	✓	✓	✓
Generic Trunking (FEC/GEC)/802.3ad-Draft Static	✓		✓	✓

Smart Load Balancing and Failover

The Smart Load Balancing™ and Failover type of team provides both load balancing and failover when configured for load balancing, and only failover when configured for fault tolerance. This type of team works with any Ethernet switch and requires no trunking configuration on the switch. The team advertises multiple MAC addresses and one or more IP addresses (when using secondary IP addresses). The team MAC address is selected from the list of load balance members. When the system receives an ARP request, the software-networking stack will always send an ARP Reply with the team MAC address. To begin the load balancing process, the teaming driver will modify this ARP Reply by changing the source MAC address to match one of the physical adapters.

Smart Load Balancing enables both transmit and receive load balancing based on the Layer 3/Layer 4 IP address and TCP/UDP port number. In other words, the load balancing is not done at a byte or frame level but on a TCP/UDP session basis. This methodology is required to maintain in-order delivery of frames that belong to the same socket conversation. Load balancing is supported on 2 to 8 ports. These ports can include any combination of add-in adapters and LAN on Motherboard (LOM) devices. Transmit load balancing is achieved by creating a hashing table using the source and destination IP addresses and TCP/UDP port numbers. The same combination of source and destination IP addresses and TCP/UDP port numbers will generally yield the same hash index and therefore point to the same port in the team. When a port is selected to carry all the frames of a given socket, the unique MAC address of the physical adapter is included in the frame, and not the team MAC address. This is required to comply with the IEEE 802.3 standard. If two adapters transmit using the same MAC address, then a duplicate MAC address situation would occur that the switch could not handle.

 **NOTE:** IPv6 addressed traffic will not be load balanced by SLB because ARP is not a feature of IPv6.

Receive load balancing is achieved through an intermediate driver by sending gratuitous ARPs on a client-by-client basis using the unicast address of each client as the destination address of the ARP request (also known as a directed ARP). This is considered client load balancing and not traffic load balancing. When the intermediate driver detects a significant load imbalance between the physical adapters in an SLB team, it will generate G-ARPs in an effort to redistribute incoming frames. The intermediate driver (BASP) does not answer ARP requests; only the software protocol stack provides the required ARP Reply. It is important to understand that receive load balancing is a function of the number of clients that are connecting to the system through the team interface.

SLB receive load balancing attempts to load balance incoming traffic for client machines across physical ports in the team. It uses a modified gratuitous ARP to advertise a different MAC address for the team IP Address in the sender physical and protocol address. This G-ARP is unicast with the MAC and IP Address of a client machine in the target physical and protocol address respectively. This causes the target client to update its ARP cache with a new MAC address map to the team IP address. G-ARPs are not broadcast because this would cause all clients to send their traffic to the same port. As a result, the benefits achieved through client load balancing would be eliminated, and could cause out-of-order frame delivery. This receive load balancing scheme works as long as all clients and the teamed system are on the same subnet or broadcast domain.

When the clients and the system are on different subnets, and incoming traffic has to traverse a router, the received traffic destined for the system is not load balanced. The physical adapter that the intermediate driver has selected to carry the IP flow carries all of the traffic. When the router sends a frame to the team IP address, it broadcasts an ARP request (if not in the ARP cache). The server software stack generates an ARP reply with the team MAC address, but the intermediate driver modifies the ARP reply and sends it over a particular physical adapter, establishing the flow for that session.

The reason is that ARP is not a routable protocol. It does not have an IP header and therefore, is not sent to the router or default gateway. ARP is only a local subnet protocol. In addition, since the G-ARP is not a broadcast packet, the router will not process it and will not update its own ARP cache.

The only way that the router would process an ARP that is intended for another network device is if it has Proxy ARP enabled and the host has no default gateway. This is very rare and not recommended for most applications.

Transmit traffic through a router will be load balanced as transmit load balancing is based on the source and destination IP address and TCP/UDP port number. Since routers do not alter the source and destination IP address, the load balancing algorithm works as intended.

Configuring routers for Hot Standby Routing Protocol (HSRP) does not allow for receive load balancing to occur in the adapter team. In general, HSRP allows for two routers to act as one router, advertising a virtual IP and virtual MAC address. One physical router is the active interface while the other is standby. Although HSRP can also load share nodes (using different default gateways on the host nodes) across multiple routers in HSRP groups, it always points to the primary MAC address of the team.

Generic Trunking

Generic Trunking is a switch-assisted teaming mode and requires configuring ports at both ends of the link: server interfaces and switch ports. This is often referred to as Cisco Fast EtherChannel or Gigabit EtherChannel. In addition, generic trunking supports similar implementations by other switch OEMs such as Extreme Networks Load Sharing and Bay Networks or IEEE 802.3ad Link Aggregation static mode. In this mode, the team advertises one MAC Address and one IP Address when the protocol stack responds to ARP Requests. In addition, each physical adapter in the team uses the same team MAC address when transmitting frames. This is possible since the switch at the other end of the link is aware of the teaming mode and will handle the use of a single MAC address by every port in the team. The forwarding table in the switch will reflect the trunk as a single virtual port.

In this teaming mode, the intermediate driver controls load balancing and failover for outgoing traffic only, while incoming traffic is controlled by the switch firmware and hardware. As is the case for Smart Load Balancing, the BASP intermediate driver uses the IP/TCP/UDP source and destination addresses to load balance the transmit traffic from the server. Most switches implement an XOR hashing of the source and destination MAC address.

 NOTE: Generic Trunking is not supported on iSCSI offload adapters.

Link Aggregation (IEEE 802.3ad LACP)

Link Aggregation is similar to Generic Trunking except that it uses the Link Aggregation Control Protocol to negotiate the ports that will make up the team. LACP must be enabled at both ends of the link for the team to be operational. If LACP is not available at both ends of the link, 802.3ad provides a manual aggregation that only requires both ends of the link to be in a link up state. Because manual aggregation provides for the activation of a member link without performing the LACP message exchanges, it should not be considered as reliable and robust as an LACP negotiated link. LACP automatically determines which member links can be aggregated and then aggregates them. It provides for the controlled addition and removal of physical links for the link aggregation so that no frames are lost or duplicated. The removal of aggregate link members is provided by the marker protocol that can be optionally enabled for Link Aggregation Control Protocol (LACP) enabled aggregate links.

The Link Aggregation group advertises a single MAC address for all the ports in the trunk. The MAC address of the Aggregator can be the MAC addresses of one of the MACs that make up the group. LACP and marker protocols use a multicast destination address.

The Link Aggregation control function determines which links may be aggregated and then binds the ports to an Aggregator function in the system and monitors conditions to determine if a change in the aggregation group is required. Link aggregation combines the individual capacity of multiple links to form a high performance virtual link. The failure or replacement of a link in an LACP trunk will not cause loss of connectivity. The traffic will simply be failed over to the remaining links in the trunk.

SLB (Auto-Fallback Disable)

This type of team is identical to the Smart Load Balance and Failover type of team, with the following exception—when the standby member is active, if a primary member comes back on line, the team continues using the standby member rather than switching back to the primary member. This type of team is supported only for situations in which the network cable is disconnected and reconnected to the network adapter. It is not supported for situations in which the adapter is removed/installed through Device Manager or Hot-Plug PCI.

If any primary adapter assigned to a team is disabled, the team functions as a Smart Load Balancing and Failover type of team in which auto-fallback occurs.

TOE Teaming

All four basic teaming modes support failover of traffic from a failed adapter to other working adapters. All four teaming modes also support bidirectional load-balancing of TCP/IP traffic. A primary difference between the modes is that the SLB modes use a Broadcom proprietary algorithm to control how both inbound and outbound traffic is balanced across the network interfaces in the team. This has several advantages. First, with Generic Trunking or Link Aggregation modes, the team of network adapters must be connected to a switch that is specifically configured to support that particular mode of teaming. Since there is a dependency between the switch and the host team configuration when Generic Trunking or Link Aggregation is used, it can often lead to configuration difficulties, because both ends must be configured correctly and be synchronized. Second, with Generic Trunking or Link Aggregation modes, the switch decides how inbound traffic to the team is balanced across the adapters, while BASP only controls the balancing of outbound traffic. This is problematic for TOE environments, because in order for TOE to work, state information about a given TCP connection is stored in the hardware on a given offloaded adapter, but it is not stored in the hardware on every member of the team. So teaming and TOE cannot co-exist if the teaming software cannot steer incoming TCP/IP traffic to the adapter that contains and updates the state

information for a given TCP connection.

Because Broadcom's SLB modes can control how both outbound and inbound packets are balanced across the adapters, the SLB modes are capable of ensuring that all offloaded TCP traffic for a given TCP connection goes in and out of a particular adapter. This architectural feature allows the SLB modes to also support load-balancing on adapters that have TOE enabled, since BASP is able to steer traffic on a particular TCP connection to the adapter hardware that contains offloaded state information for that TCP connection. BASP can simultaneously use TCP offload in conjunction with the SLB modes of teaming. Other teaming modes (Generic Trunking or Link Aggregation) can still be used on TOE capable devices, but if those other modes are enabled the TOE feature is disabled.

Since the TOE offloaded state is stored in only one member of a team, it might not be intuitive as to how BASP can support failover on TOE teams. When a TOE connection has been offloaded to a given adapter, and if that network interface fails in some way (that is, it loses its network link due to a cable disconnection), then BASP will detect the error and force an upload of the offloaded TCP state for each previously offloaded TCP connection on that adapter to the host. Once all of the previously offloaded state has been uploaded, BASP will rebalance the recently uploaded TCP connections and offload those connections evenly to the remaining members of the team. Basically, if there is a failure on a TOE-enabled adapter, any TCP connections that had been offloaded to that adapter are migrated to the remaining nonfailed members in the team.

For Broadcom NetXtreme II adapters, there are no specific setup requirements in order for TCP Offload Engine (TOE) to work with BASP. Once the individual adapters are configured to enable TOE, they can be added to a team and the offload is transparent to BASP. For information on configuring TOE, see [Viewing and Configuring Resource Reservations](#).

Limitations of Teaming with Offloading

- TOE is enabled for a team only when all of the members support and are configured for TOE.
- TOE is only supported on SLB-type teams.
- Each virtual BASP device advertises 1024 offload connections. If the number of virtual BASP devices in a team exceeds the number of active physical members, the maximum offload connections for each virtual device may be lower.

Software Components

Teaming is implemented via an NDIS intermediate driver in the Windows Operating System environment. This software component works with the miniport driver, the NDIS layer, and the protocol stack to enable the teaming architecture (see [Figure 2](#)). The miniport driver controls the host LAN controller directly to enable functions such as sends, receives, and interrupt processing. The intermediate driver fits between the miniport driver and the protocol layer multiplexing several miniport driver instances, and creating a virtual adapter that looks like a single adapter to the NDIS layer. NDIS provides a set of library functions to enable the communications between either miniport drivers or intermediate drivers and the protocol stack. The protocol stack implements IP, IPX and ARP. A protocol address such as an IP address is assigned to each miniport device instance, but when an Intermediate driver is installed, the protocol address is assigned to the virtual team adapter and not to the individual miniport devices that make up the team.

The Broadcom supplied teaming support is provided by three individual software components that work together and are supported as a package. When one component is upgraded, all the other components must be upgraded to the supported versions. [Table 3](#) describes the four software components and their associated files for supported operating systems.

Table 3: Broadcom Teaming Software Component

Software Component	Broadcom Name	Network Adapter/Operating System	System Architecture	Windows File Name
	Virtual Bus Driver (VBD)	BCM5708, BCM5709	32-bit	bxvbdx.sys
		BCM5708, BCM5709	64-bit	bxvbda.sys
		BCM57710, BCM57711, BCM57712, BCM57840	32-bit	evbdx.sys
		BCM57710, BCM57711, BCM57712, BCM57840	64-bit	evbda.sys
Miniport Driver	Broadcom Base Driver	Windows Server 2008 (NDIS 6.0)	32-bit	bxnd60x.sys
		Windows Server 2008 (NDIS 6.0)	64-bit	bxnd60a.sys
		Windows Server 2008 R2 (NDIS 6.0)	64-bit	bxnd60a.sys
		Windows Server 2012	64-bit	bxnd60a.sys
	Broadcom Advanced Server	Windows Server 2008	32-bit, 64-bit	basp.sys

Intermediate Driver	Program (BASP)	Windows Server 2008 R2	64-bit	basps.sys
		Windows Server 2012	64-bit	basps.sys
Configuration User Interface	Broadcom Advanced Control Suite (BACS)	Windows Server 2008	–	bacs.exe
		Windows Server 2008 R2	–	bacs.exe
		Windows Server 2012	–	bacs.exe

Hardware Requirements

- Repeater Hub
- Switching Hub
- Router

The various teaming modes described in this document place certain restrictions on the networking equipment used to connect clients to teamed systems. Each type of network interconnect technology has an effect on teaming as described in the following sections.

Repeater Hub

A Repeater Hub allows a network administrator to extend an Ethernet network beyond the limits of an individual segment. The repeater regenerates the input signal received on one port onto all other connected ports, forming a single collision domain. This means that when a station attached to a repeater sends an Ethernet frame to another station, every station within the same collision domain will also receive that message. If two stations begin transmitting at the same time, a collision occurs, and each transmitting station must retransmit its data after waiting a random amount of time.

The use of a repeater requires that each station participating within the collision domain operate in half-duplex mode. Although half-duplex mode is supported for Gigabit Ethernet adapters in the IEEE 802.3 specification, half-duplex mode is not supported by the majority of Gigabit Ethernet adapter manufacturers. Therefore, half-duplex mode is not considered here.

Teaming across hubs is supported for troubleshooting purposes (such as connecting a network analyzer) for SLB teams only.

Switching Hub

Unlike a repeater hub, a switching hub (or more simply a switch) allows an Ethernet network to be broken into multiple collision domains. The switch is responsible for forwarding Ethernet packets between hosts based solely on Ethernet MAC addresses. A physical network adapter that is attached to a switch may operate in half-duplex or full-duplex mode.

To support Generic Trunking and 802.3ad Link Aggregation, a switch must specifically support such functionality. If the switch does not support these protocols, it may still be used for Smart Load Balancing.



NOTE: All modes of network teaming are supported across switches when operating as a stackable switch.

Router

A router is designed to route network traffic based on Layer 3 or higher protocols, although it often also works as a Layer 2 device with switching capabilities. The teaming of ports connected directly to a router is not supported.

Teaming Support by Processor

All team types are supported by the IA-32 and EM64T processors.

Configuring Teaming

The Broadcom Advanced Control Suite utility is used to configure teaming in the supported operating system environments.

The Broadcom Advanced Control Suite (BACS) utility is designed to run on 32-bit and 64-bit Windows family of operating systems. BACS is used to configure load balancing and fault tolerance teaming, and VLANs. In addition, it displays the MAC address, driver version, and status information about each network adapter. BACS also includes a number of diagnostics tools such as hardware diagnostics, cable testing, and a network topology test.

Supported Features by Team Type

Table 4 provides a feature comparison across the team types supported by Dell. Use this table to determine the best type of team for your application. The teaming software supports up to eight ports in a single team and up to 16 teams in a single system. These teams can be any combination of the supported teaming types, but each team must be on a separate network or subnet.

Table 4: Comparison of Team Types

Type of Team	Fault Tolerance	Load Balancing	Switch-Dependent Static Trunking	Switch-Independent Dynamic Link Aggregation (IEEE 802.3ad)
Function	SLB with Standby ^a	SLB	Generic Trunking	Link Aggregation
Number of ports per team (same broadcast domain)	2–8	2–8	2–8	2–8
Number of teams	16	16	16	16
Adapter fault tolerance	Yes	Yes	Yes	Yes
Switch link fault tolerance (same broadcast domain)	Yes	Yes	Switch-dependent	Switch-dependent
TX load balancing	No	Yes	Yes	Yes
RX load balancing	No	Yes	Yes (performed by the switch)	Yes (performed by the switch)
Requires compatible switch	No	No	Yes	Yes
Heartbeats to check connectivity	No	No	No	No
Mixed media (adapters with different media)	Yes	Yes	Yes (switch-dependent)	Yes
Mixed speeds (adapters that do not support a common speed(s), but can operate at different speeds)	Yes	Yes	No	No
Mixed speeds (adapters that support a common speed(s), but can operate at different speeds)	Yes	Yes	No (must be the same speed)	Yes
Load balances TCP/IP	No	Yes	Yes	Yes
Mixed vendor teaming	Yes ^b	Yes ^b	Yes ^b	Yes ^b
Load balances non-IP	No	Yes (IPX outbound traffic only)	Yes	Yes
Same MAC address for all team members	No	No	Yes	Yes
Same IP address for all team members	Yes	Yes	Yes	Yes
Load balancing by IP address	No	Yes	Yes	Yes
Load balancing by MAC address	No	Yes (used for no-IP/IPX)	Yes	Yes
Allows TOE functionality to co-exist when all team members support TOE ^c	Yes	Yes	No	No

^a SLB with one primary and one standby member.

^b Requires at least one Broadcom adapter in the team.

^c TOE functionality can only be achieved with SLB teams that consist of all Broadcom TOE-enabled adapters.

Selecting a Team Type

The following flow chart provides the decision flow when planning for Layer 2 teaming. For TOE teaming, only Smart Load Balancing™ and Failover type team is supported. The primary rationale for teaming is the need for additional network bandwidth and fault tolerance. Teaming offers link aggregation and fault tolerance to meet both of these requirements. Preference teaming should be selected in the following order: Link Aggregation as the first choice, Generic Trunking as the second choice, and SLB teaming as the third choice when using unmanaged switches or switches that do not support the first two options. If switch fault tolerance is a requirement, then SLB is the only choice (see Figure 1).

Figure 1: Process for Selecting a Team Type

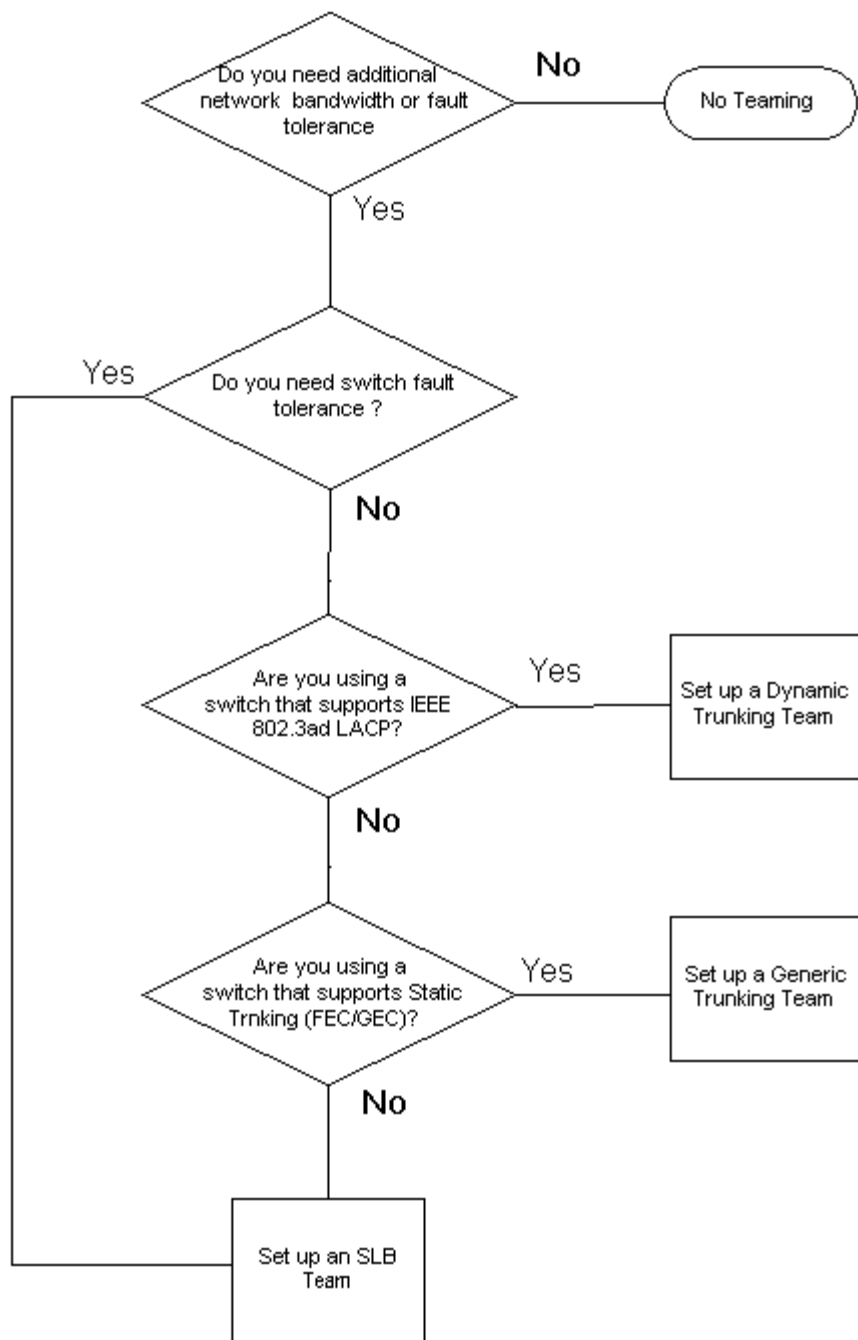

Teaming Mechanisms

- [Architecture](#)
- [Types of Teams](#)
- [Attributes of the Features Associated with Each Type of Team](#)
- [Speeds Supported for Each Type of Team](#)

Architecture

The Broadcom Advanced Server Program is implemented as an NDIS intermediate driver (see [Figure 2](#)). It operates below protocol stacks such as TCP/IP and IPX and appears as a virtual adapter. This virtual adapter inherits the MAC Address of the first port initialized in the team. A Layer 3 address must also be configured for the virtual adapter. The primary function of BASP is to balance inbound (for SLB) and outbound traffic (for all teaming modes) among the physical adapters installed on

the system selected for teaming. The inbound and outbound algorithms are independent and orthogonal to each other. The outbound traffic for a particular session can be assigned to a given port while its corresponding inbound traffic can be assigned to a different port.

Figure 2: Intermediate Driver

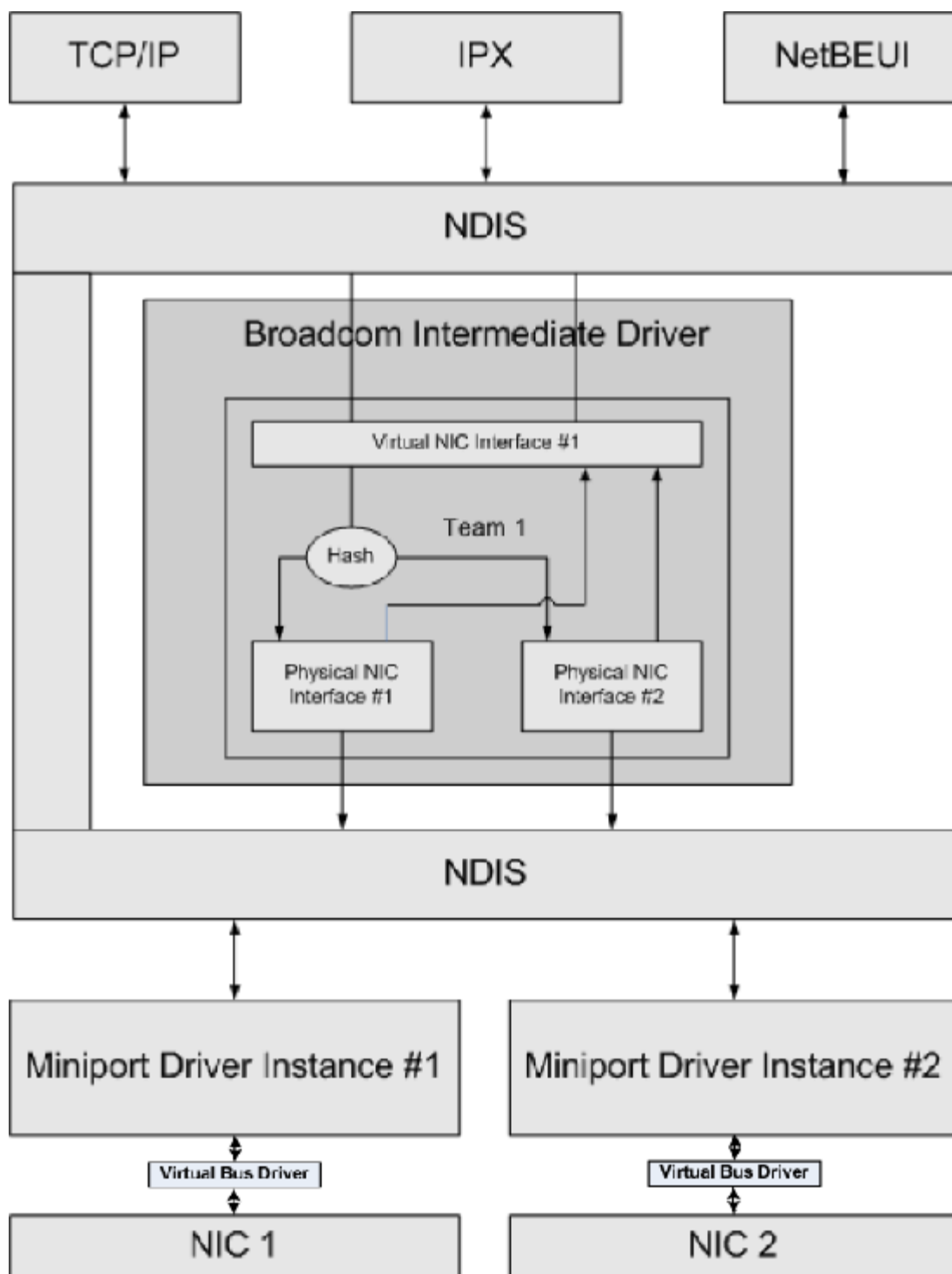

Outbound Traffic Flow

The Broadcom Intermediate Driver manages the outbound traffic flow for all teaming modes. For outbound traffic, every packet is first classified into a flow, and then distributed to the selected physical adapter for transmission. The flow classification involves an efficient hash computation over known protocol fields. The resulting hash value is used to index into an Outbound Flow Hash Table. The selected Outbound Flow Hash Entry contains the index of the selected physical adapter responsible for transmitting this flow. The source MAC address of the packets will then be modified to the MAC address of the selected physical adapter. The modified packet is then passed to the selected physical adapter for transmission.

The outbound TCP and UDP packets are classified using Layer 3 and Layer 4 header information. This scheme improves the load distributions for popular Internet protocol services using well-known ports such as HTTP and FTP. Therefore, BASP performs load balancing on a TCP session basis and not on a packet-by-packet basis.

In the Outbound Flow Hash Entries, statistics counters are also updated after classification. The load-balancing engine uses these counters to periodically distribute the flows across teamed ports. The outbound code path has been designed to achieve best possible concurrency where multiple concurrent accesses to the Outbound Flow Hash Table are allowed.

For protocols other than TCP/IP, the first physical adapter will always be selected for outbound packets. The exception is Address Resolution Protocol (ARP), which is handled differently to achieve inbound load balancing.

Inbound Traffic Flow (SLB Only)

The Broadcom intermediate driver manages the inbound traffic flow for the SLB teaming mode. Unlike outbound load balancing, inbound load balancing can only be applied to IP addresses that are located in the same subnet as the load-balancing server. Inbound load balancing exploits a unique characteristic of Address Resolution Protocol (RFC0826), in which each IP host uses its own ARP cache to encapsulate the IP Datagram into an Ethernet frame. BASP carefully manipulates the ARP response to direct each IP host to send the inbound IP packet to the desired physical adapter. Therefore, inbound load balancing is a plan-ahead scheme based on statistical history of the inbound flows. New connections from a client to the server will always occur over the primary physical adapter (because the ARP Reply generated by the operating system protocol stack will always associate the logical IP address with the MAC address of the primary physical adapter).

Like the outbound case, there is an Inbound Flow Head Hash Table. Each entry inside this table has a singly linked list and each link (Inbound Flow Entries) represents an IP host located in the same subnet.

When an inbound IP Datagram arrives, the appropriate Inbound Flow Head Entry is located by hashing the source IP address of the IP Datagram. Two statistics counters stored in the selected entry are also updated. These counters are used in the same fashion as the outbound counters by the load-balancing engine periodically to reassign the flows to the physical adapter.

On the inbound code path, the Inbound Flow Head Hash Table is also designed to allow concurrent access. The link lists of Inbound Flow Entries are only referenced in the event of processing ARP packets and the periodic load balancing. There is no per packet reference to the Inbound Flow Entries. Even though the link lists are not bounded; the overhead in processing each non-ARP packet is always a constant. The processing of ARP packets, both inbound and outbound, however, depends on the number of links inside the corresponding link list.

On the inbound processing path, filtering is also employed to prevent broadcast packets from looping back through the system from other physical adapters.

Protocol Support

ARP and IP/TCP/UDP flows are load balanced. If the packet is an IP protocol only, such as ICMP or IGMP, then all data flowing to a particular IP address will go out through the same physical adapter. If the packet uses TCP or UDP for the L4 protocol, then the port number is added to the hashing algorithm, so two separate L4 flows can go out through two separate physical adapters to the same IP address.

For example, assume the client has an IP address of 10.0.0.1. All IGMP and ICMP traffic will go out the same physical adapter because only the IP address is used for the hash. The flow would look something like this:

```
IGMP -----> PhysAdapter1 -----> 10.0.0.1
```

```
ICMP -----> PhysAdapter1 -----> 10.0.0.1
```

If the server also sends an TCP and UDP flow to the same 10.0.0.1 address, they can be on the same physical adapter as IGMP and ICMP, or on completely different physical adapters from ICMP and IGMP. The stream may look like this:

```
IGMP -----> PhysAdapter1 -----> 10.0.0.1
```

```
ICMP -----> PhysAdapter1 -----> 10.0.0.1
```

```
TCP-----> PhysAdapter1 -----> 10.0.0.1
```

```
UDP-----> PhysAdatper1 -----> 10.0.0.1
```

Or the streams may look like this:

```
IGMP -----> PhysAdapter1 -----> 10.0.0.1
```

ICMP -----> PhysAdapter1 -----> 10.0.0.1

TCP-----> PhysAdapter2 -----> 10.0.0.1

UDP-----> PhysAdatper3 -----> 10.0.0.1

The actual assignment between adapters may change over time, but any protocol that is not TCP/UDP based goes over the same physical adapter because only the IP address is used in the hash.

Performance

Modern network interface cards provide many hardware features that reduce CPU utilization by offloading certain CPU intensive operations (see [Teaming and Other Advanced Networking Properties](#)). In contrast, the BASP intermediate driver is a purely software function that must examine every packet received from the protocol stacks and react to its contents before sending it out through a particular physical interface. Though the BASP driver can process each outgoing packet in near constant time, some applications that may already be CPU bound may suffer if operated over a teamed interface. Such an application may be better suited to take advantage of the failover capabilities of the intermediate driver rather than the load balancing features, or it may operate more efficiently over a single physical adapter that provides a particular hardware feature such as Large Send Offload.

Types of Teams

Switch-Independent

The Broadcom Smart Load Balancing type of team allows two to eight physical adapters to operate as a single virtual adapter. The greatest benefit of the SLB type of team is that it operates on any IEEE compliant switch and requires no special configuration.

Smart Load Balancing and Failover

SLB provides for switch-independent, bidirectional, fault-tolerant teaming and load balancing. Switch independence implies that there is no specific support for this function required in the switch, allowing SLB to be compatible with all switches. Under SLB, all adapters in the team have separate MAC addresses. The load-balancing algorithm operates on Layer 3 addresses of the source and destination nodes, which enables SLB to load balance both incoming and outgoing traffic.

The BASP intermediate driver continually monitors the physical ports in a team for link loss. In the event of link loss on any port, traffic is automatically diverted to other ports in the team. The SLB teaming mode supports switch fault tolerance by allowing teaming across different switches- provided the switches are on the same physical network or broadcast domain.

Network Communications

The following are the key attributes of SLB:

- Failover mechanism – Link loss detection.
- Load Balancing Algorithm – Inbound and outbound traffic are balanced through a Broadcom proprietary mechanism based on L4 flows.
- Outbound Load Balancing using MAC Address - No.
- Outbound Load Balancing using IP Address - Yes
- Multivendor Teaming – Supported (must include at least one Broadcom Ethernet adapter as a team member).

Applications

The SLB algorithm is most appropriate in home and small business environments where cost is a concern or with commodity switching equipment. SLB teaming works with unmanaged Layer 2 switches and is a cost-effective way of getting redundancy and link aggregation at the server. Smart Load Balancing also supports teaming physical adapters with differing link capabilities. In addition, SLB is recommended when switch fault tolerance with teaming is required.

Configuration Recommendations

SLB supports connecting the teamed ports to hubs and switches if they are on the same broadcast domain. It does not support connecting to a router or Layer 3 switches because the ports must be on the same subnet.

Switch-Dependent

Generic Static Trunking

This mode supports a variety of environments where the adapter link partners are statically configured to support a proprietary trunking mechanism. This mode could be used to support Lucent's *Open Trunk*, Cisco's *Fast EtherChannel (FEC)*, and Cisco's *Gigabit EtherChannel (GEC)*. In the static mode, as in generic link aggregation, the switch administrator needs to assign the ports to the team, and this assignment cannot be altered by the BASP, as there is no exchange of the Link Aggregation Control Protocol (LACP) frame.

With this mode, all adapters in the team are configured to receive packets for the same MAC address. Trunking operates on Layer 2 addresses and supports load balancing and failover for both inbound and outbound traffic. The BASP driver determines the load-balancing scheme for outbound packets, using Layer 4 protocols previously discussed, whereas the team link partner determines the load-balancing scheme for inbound packets.

The attached switch must support the appropriate trunking scheme for this mode of operation. Both the BASP and the switch continually monitor their ports for link loss. In the event of link loss on any port, traffic is automatically diverted to other ports in the team.

Network Communications

The following are the key attributes of Generic Static Trunking:

- Failover mechanism – Link loss detection
- Load Balancing Algorithm – Outbound traffic is balanced through Broadcom proprietary mechanism based L4 flows. Inbound traffic is balanced according to a switch specific mechanism.
- Outbound Load Balancing using MAC Address – No
- Outbound Load Balancing using IP Address - Yes
- Multivendor teaming – Supported (Must include at least one Broadcom Ethernet adapter as a team member)

Applications

Generic trunking works with switches that support Cisco Fast EtherChannel, Cisco Gigabit EtherChannel, Extreme Networks Load Sharing and Bay Networks or IEEE 802.3ad Link Aggregation static mode. Since load balancing is implemented on Layer 2 addresses, all higher protocols such as IP, IPX, and NetBEUI are supported. Therefore, this is the recommended teaming mode when the switch supports generic trunking modes over SLB.

Configuration Recommendations

Static trunking supports connecting the teamed ports to switches if they are on the same broadcast domain and support generic trunking. It does not support connecting to a router or Layer 3 switches since the ports must be on the same subnet.

Dynamic Trunking (IEEE 802.3ad Link Aggregation)

This mode supports link aggregation through static and dynamic configuration via the Link Aggregation Control Protocol (LACP). With this mode, all adapters in the team are configured to receive packets for the same MAC address. The MAC address of the first adapter in the team is used and cannot be substituted for a different MAC address. The BASP driver determines the load-balancing scheme for outbound packets, using Layer 4 protocols previously discussed, whereas the team's link partner determines the load-balancing scheme for inbound packets. Because the load balancing is implemented on Layer 2, all higher protocols such as IP, IPX, and NetBEUI are supported. The attached switch must support the 802.3ad Link Aggregation standard for this mode of operation. The switch manages the inbound traffic to the adapter while the BASP manages the outbound traffic. Both the BASP and the switch continually monitor their ports for link loss. In the event of link loss on any port, traffic is automatically diverted to other ports in the team.

Network Communications

The following are the key attributes of Dynamic Trunking:

- Failover mechanism – Link loss detection
- Load Balancing Algorithm – Outbound traffic is balanced through a Broadcom proprietary mechanism based on L4 flows. Inbound traffic is balanced according to a switch specific mechanism.
- Outbound Load Balancing using MAC Address - No
- Outbound Load Balancing using IP Address - Yes

- Multivendor teaming – Supported (Must include at least one Broadcom Ethernet adapter as a team member)

Applications

Dynamic trunking works with switches that support IEEE 802.3ad Link Aggregation dynamic mode using LACP. Inbound load balancing is switch dependent. In general, the switch traffic is load balanced based on L2 addresses. In this case, all network protocols such as IP, IPX, and NetBEUI are load balanced. Therefore, this is the recommended teaming mode when the switch supports LACP, except when switch fault tolerance is required. SLB is the only teaming mode that supports switch fault tolerance.

Configuration Recommendations

Dynamic trunking supports connecting the teamed ports to switches as long as they are on the same broadcast domain and supports IEEE 802.3ad LACP trunking. It does not support connecting to a router or Layer 3 switches since the ports must be on the same subnet.

LiveLink™

LiveLink™ is a feature of BASP that is available for the Smart Load Balancing (SLB) and SLB (Auto-Fallback Disable) types of teaming. The purpose of LiveLink is to detect link loss beyond the switch and to route traffic only through team members that have a live link. This function is accomplished through the teaming software. The teaming software periodically probes (issues a link packet from each team member) one or more specified target network device(s). The probe target(s) responds when it receives the link packet. If a team member does not detect the response within a specified amount of time, this indicates that the link has been lost, and the teaming software discontinues passing traffic through that team member. Later, if that team member begins to detect a response from a probe target, this indicates that the link has been restored, and the teaming software automatically resumes passing traffic through that team member. LiveLink works only with TCP/IP.

LiveLink™ functionality is supported in both 32-bit and 64-bit Windows operating systems. For similar functionality in Linux operating systems, see the Channel Bonding information in your Red Hat documentation.

Attributes of the Features Associated with Each Type of Team

The attributes of the features associated with each type of team are summarized in [Table 5](#).

Table 5: Attributes

Feature	Attribute
Smart Load Balancing™	
User interface	Broadcom Advanced Control Suite (BACS)
Number of teams	Maximum 16
Number of adapters per team	Maximum 8
Hot replace	Yes
Hot add	Yes
Hot remove	Yes
Link speed support	Different speeds
Frame protocol	IP
Incoming packet management	BASP
Outgoing packet management	BASP
LiveLink support	Yes
Failover event	Loss of link
Failover time	<500 ms
Fallback time	1.5 s ^b (approximate)
MAC address	Different
Multivendor teaming	Yes
Generic Trunking	
User interface	Broadcom Advanced Control Suite (BACS)
Number of teams	Maximum 16
Number of adapters per team	Maximum 8

Hot replace	Yes
Hot add	Yes
Hot remove	Yes
Link speed support	Different speeds ^a
Frame protocol	All
Incoming packet management	Switch
Outgoing packet management	BASP
Failover event	Loss of link only
Failover time	<500 ms
Fallback time	1.5 s ^b (approximate)
MAC address	Same for all adapters
Multivendor teaming	Yes
Dynamic Trunking	
User interface	Broadcom Advanced Control Suite (BACS)
Number of teams	Maximum 16
Number of adapters per team	Maximum 8
Hot replace	Yes
Hot add	Yes
Hot remove	Yes
Link speed support	Different speeds
Frame protocol	All
Incoming packet management	Switch
Outgoing packet management	BASP
Failover event	Loss of link only
Failover time	<500 ms
Fallback time	1.5 s ^b (approximate)
MAC address	Same for all adapters
Multivendor teaming	Yes

^a Some switches require matching link speeds to correctly negotiate between trunk connections.

^b Make sure that Port Fast or Edge Port is enabled.

Speeds Supported for Each Type of Team

The various link speeds that are supported for each type of team are listed in [Table 6](#). Mixed speed refers to the capability of teaming adapters that are running at different link speeds.

Table 6: Link Speeds in Teaming

Type of Team	Link Speed	Traffic Direction	Speed Support
SLB	10/100/1000/10000	Incoming/outgoing	Mixed speed
FEC	100	Incoming/outgoing	Same speed
GEC	1000	Incoming/outgoing	Same speed
IEEE 802.3ad	10/100/1000/10000	Incoming/outgoing	Mixed speed

Teaming and Other Advanced Networking Properties

- Checksum Offload
- IEEE 802.1p QoS Tagging
- Large Send Offload

- TCP Offload Engine (TOE)
- Jumbo Frames
- IEEE 802.1Q VLANs
- Wake On LAN
- Preboot Execution Environment

Before creating a team, adding or removing team members, or changing advanced settings of a team member, make sure each team member has been configured similarly. Settings to check include VLANs and QoS Packet Tagging, Jumbo Frames, and the various offloads. Advanced adapter properties and teaming support are listed in [Table 7](#).

Table 7: Advanced Adapter Properties and Teaming Support

Adapter Properties	Supported by Teaming Virtual Adapter
Checksum Offload	Yes
IEEE 802.1p QoS Tagging	No
Large Send Offload	Yes ^a
TCP Offload Engine (TOE)	Yes ^{b, c}
Jumbo Frames	Yes ^b
IEEE 802.1Q VLANs	Yes ^c
Wake on LAN	No ^d
Preboot Execution environment (PXE)	Yes ^e

^a All adapters on the team must support this feature. Some adapters may not support this feature if ASF/IPMI is also enabled.

^b Must be supported by all adapters in the team.

^c Only for Broadcom adapters.

^d See [Wake On LAN](#).

^e As a PXE sever only, not as a client.

A team does not necessarily inherit adapter properties; rather various properties depend on the specific capability. For instance, an example would be flow control, which is a physical adapter property and has nothing to do with BASP, and will be enabled on a particular adapter if the miniport driver for that adapter has flow control enabled.

 NOTE: All adapters on the team must support the property listed in [Table 7](#) in order for the team to support the property.

Checksum Offload

Checksum Offload is a property of the Broadcom network adapters that allows the TCP/IP/UDP checksums for send and receive traffic to be calculated by the adapter hardware rather than by the host CPU. In high-traffic situations, this can allow a system to handle more connections more efficiently than if the host CPU were forced to calculate the checksums. This property is inherently a hardware property and would not benefit from a software-only implementation. An adapter that supports Checksum Offload advertises this capability to the operating system so that the checksum does not need to be calculated in the protocol stack. Checksum Offload is only supported for IPv4 at this time.

IEEE 802.1p QoS Tagging

The IEEE 802.1p standard includes a 3-bit field (supporting a maximum of 8 priority levels), which allows for traffic prioritization. The BASP intermediate driver does not support IEEE 802.1p QoS tagging.

Large Send Offload

Large Send Offload (LSO) is a feature provided by Broadcom network adapters that prevents an upper level protocol such as TCP from breaking a large data packet into a series of smaller packets with headers appended to them. The protocol stack need only generate a single header for a data packet as large as 64 KB, and the adapter hardware breaks the data buffer into appropriately-sized Ethernet frames with the correctly sequenced header (based on the single header originally provided).

TCP Offload Engine (TOE)

The TCP/IP protocol suite is used to provide transport services for a wide range of applications for the Internet, LAN, and for file transfer. Without the TCP Offload Engine, the TCP/IP protocol suite runs on the host CPU, consuming a very high percentage of its resources and leaving little resources for the applications. With the use of the Broadcom NetXtreme II adapter, the TCP/IP processing can be moved to hardware, freeing the CPU for more important tasks such as application processing.

The Broadcom NetXtreme II adapter's TOE functionality allows simultaneous operation of up to 1024 fully offloaded TCP connections for 1-Gbps network adapters and 1880 fully offloaded TCP connections for 10-Gbps network adapters. The TOE support on the adapter significantly reduces the host CPU utilization while preserving the implementation of the operating system stack.

Jumbo Frames

The use of jumbo frames was originally proposed by Alteon Networks, Inc. in 1998 and increased the maximum size of an Ethernet frame to a maximum size of 9000 bytes. Though never formally adopted by the IEEE 802.3 Working Group, support for jumbo frames has been implemented in Broadcom NetXtreme II adapters. The BASP intermediate driver supports jumbo frames, provided that all of the physical adapters in the team also support jumbo frames and the same size is set on all adapters in the team.

IEEE 802.1Q VLANs

In 1998, the IEEE approved the 802.3ac standard, which defines frame format extensions to support Virtual Bridged Local Area Network tagging on Ethernet networks as specified in the IEEE 802.1Q specification. The VLAN protocol permits insertion of a tag into an Ethernet frame to identify the VLAN to which a frame belongs. If present, the 4-byte VLAN tag is inserted into the Ethernet frame between the source MAC address and the length/type field. The first 2-bytes of the VLAN tag consist of the IEEE 802.1Q tag type, whereas the second 2 bytes include a user priority field and the VLAN identifier (VID). Virtual LANs (VLANs) allow the user to split the physical LAN into logical subparts. Each defined VLAN behaves as its own separate network, with its traffic and broadcasts isolated from the others, thus increasing bandwidth efficiency within each logical group. VLANs also enable the administrator to enforce appropriate security and quality of service (QoS) policies. The BASP supports the creation of 64 VLANs per team or adapter: 63 tagged and 1 untagged. The operating system and system resources, however, limit the actual number of VLANs. VLAN support is provided according to IEEE 802.1Q and is supported in a teaming environment as well as on a single adapter. Note that VLANs are supported only with homogeneous teaming and not in a multivendor teaming environment. The BASP intermediate driver supports VLAN tagging. One or more VLANs may be bound to a single instance of the intermediate driver.

Wake On LAN

Wake on LAN (WOL) is a feature that allows a system to be awakened from a sleep state by the arrival of a specific packet over the Ethernet interface. Because a Virtual Adapter is implemented as a software only device, it lacks the hardware features to implement Wake on LAN and cannot be enabled to wake the system from a sleeping state via the Virtual Adapter. The physical adapters, however, support this property, even when the adapter is part of a team.

Preboot Execution Environment

The Preboot Execution Environment (PXE) allows a system to boot from an operating system image over the network. By definition, PXE is invoked before an operating system is loaded, so there is no opportunity for the BASP intermediate driver to load and enable a team. As a result, teaming is not supported as a PXE client, though a physical adapter that participates in a team when the operating system is loaded may be used as a PXE client. Whereas a teamed adapter cannot be used as a PXE client, it can be used for a PXE server, which provides operating system images to PXE clients using a combination of Dynamic Host Control Protocol (DHCP) and the Trivial File Transfer Protocol (TFTP). Both of these protocols operate over IP and are supported by all teaming modes.

General Network Considerations

- [Teaming with Microsoft Virtual Server 2005](#)
- [Teaming Across Switches](#)
- [Spanning Tree Algorithm](#)

- Layer 3 Routing/Switching
- Teaming with Hubs (for troubleshooting purposes only)
- Teaming with Microsoft NLB

Teaming with Microsoft Virtual Server 2005

The only supported BASP team configuration when using Microsoft Virtual Server 2005 is with a Smart Load Balancing (TM) team-type consisting of a single primary Broadcom adapter and a standby Broadcom adapter. Make sure to unbind or deselect "Virtual Machine Network Services" from each team member prior to creating a team and prior to creating Virtual networks with Microsoft Virtual Server. Additionally, a virtual network should be created in this software and subsequently bound to the virtual adapter created by a team. Directly binding a Guest operating system to a team virtual adapter may not render the desired results.

 NOTE: As of this writing, Windows Server 2008 is not a supported operating system for Microsoft Virtual Server 2005; thus, teaming may not function as expected with this combination.

Teaming Across Switches

SLB teaming can be configured across switches. The switches, however, must be connected together. Generic Trunking and Link Aggregation do not work across switches because each of these implementations requires that all physical adapters in a team share the same Ethernet MAC address. It is important to note that SLB can only detect the loss of link between the ports in the team and their immediate link partner. SLB has no way of reacting to other hardware failures in the switches and cannot detect loss of link on other ports.

Switch-Link Fault Tolerance

The diagrams below describe the operation of an SLB team in a switch fault tolerant configuration. We show the mapping of the ping request and ping replies in an SLB team with two active members. All servers (Blue, Gray and Red) have a continuous ping to each other. [Figure 3](#) is a setup without the interconnect cable in place between the two switches. [Figure 4](#) has the interconnect cable in place, and [Figure 5](#) is an example of a failover event with the Interconnect cable in place. These scenarios describe the behavior of teaming across the two switches and the importance of the interconnect link.

The diagrams show the secondary team member sending the ICMP echo requests (yellow arrows) while the primary team member receives the respective ICMP echo replies (blue arrows). This illustrates a key characteristic of the teaming software. The load balancing algorithms do not synchronize how frames are load balanced when sent or received. In other words, frames for a given conversation can go out and be received on different interfaces in the team. This is true for all types of teaming supported by Broadcom. Therefore, an interconnect link must be provided between the switches that connect to ports in the same team.

In the configuration without the interconnect, an ICMP Request from Blue to Gray goes out port 82:83 destined for Gray port 5E:CA, but the Top Switch has no way to send it there because it cannot go along the 5E:C9 port on Gray. A similar scenario occurs when Gray attempts to ping Blue. An ICMP Request goes out on 5E:C9 destined for Blue 82:82, but cannot get there. Top Switch does not have an entry for 82:82 in its CAM table because there is no interconnect between the two switches. Pings, however, flow between Red and Blue and between Red and Gray.

Furthermore, a failover event would cause additional loss of connectivity. Consider a cable disconnect on the Top Switch port 4. In this case, Gray would send the ICMP Request to Red 49:C9, but because the Bottom switch has no entry for 49:C9 in its CAM Table, the frame is flooded to all its ports but cannot find a way to get to 49:C9.

Figure 3: Teaming Across Switches Without an Interswitch Link

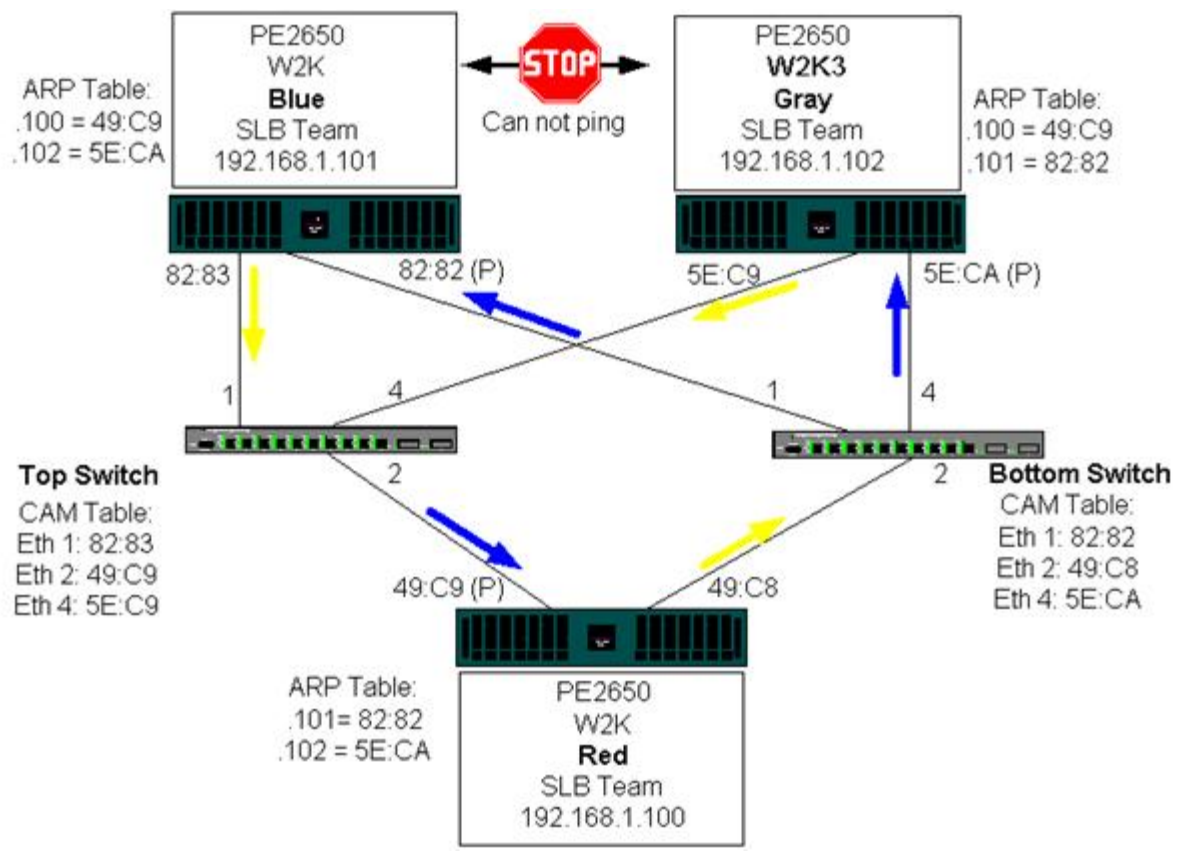

The addition of a link between the switches allows traffic from/to Blue and Gray to reach each other without any problems. Note the additional entries in the CAM table for both switches. The link interconnect is critical for the proper operation of the team. As a result, it is highly advisable to have a link aggregation trunk to interconnect the two switches to ensure high availability for the connection.

Figure 4: Teaming Across Switches With Interconnect

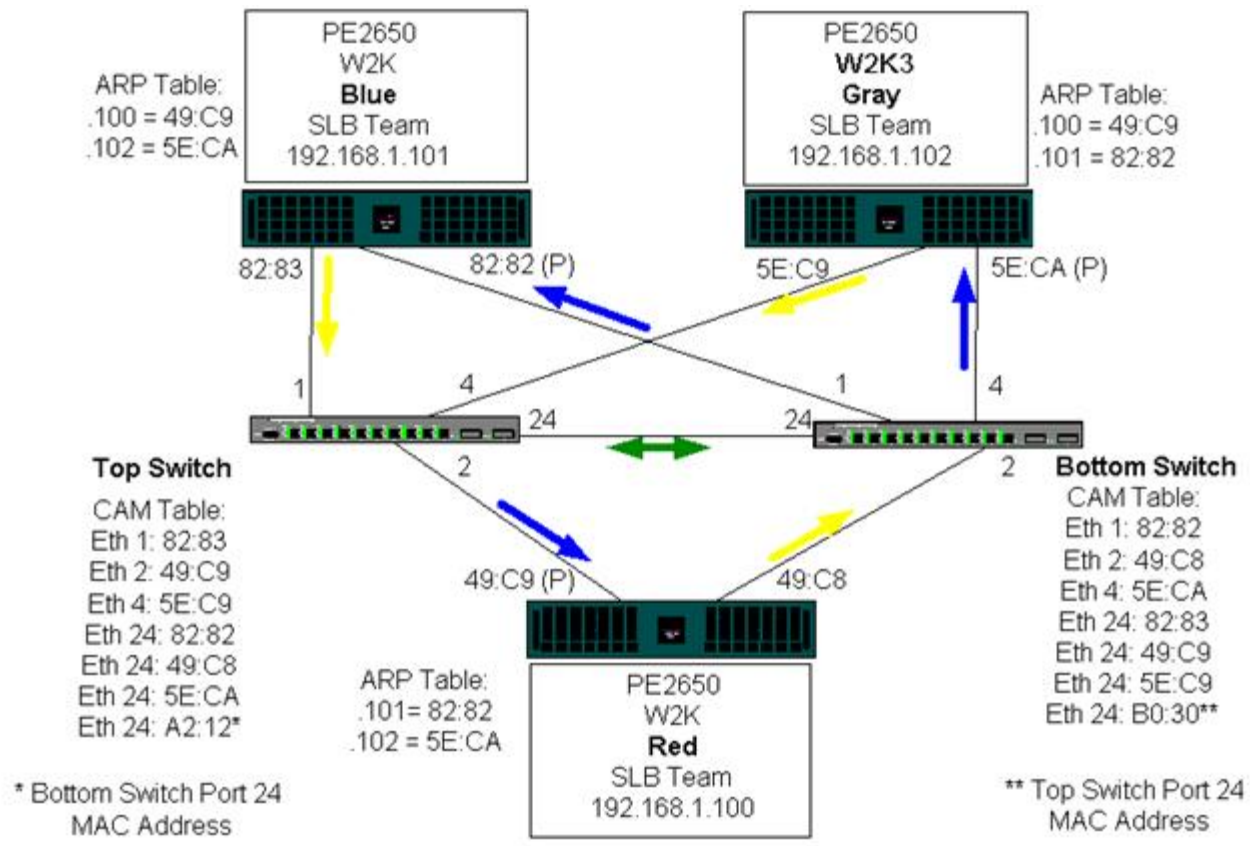
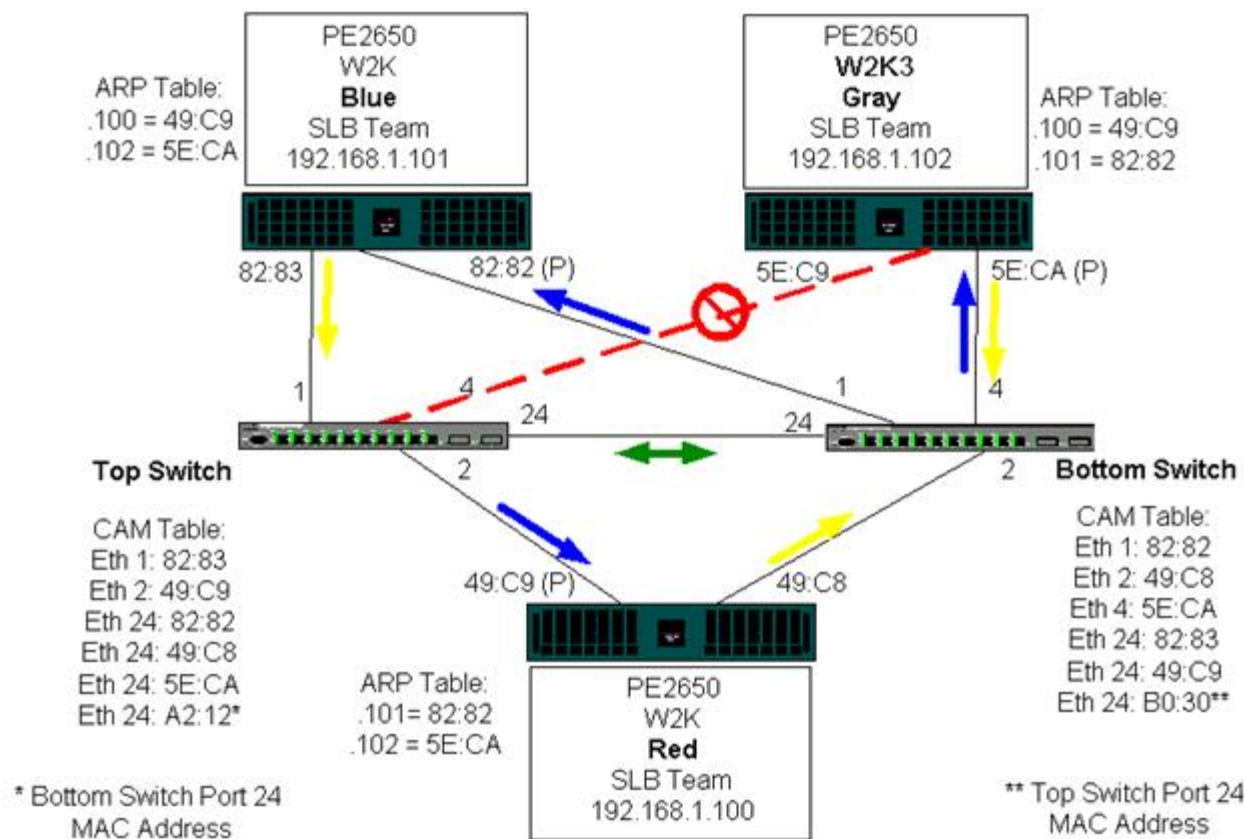

Figure 5 represents a failover event in which the cable is unplugged on the Top Switch port 4. This is a successful failover with all stations pinging each other without loss of connectivity.

Figure 5: Failover Event



Spanning Tree Algorithm

- Topology Change Notice (TCN)
- Port Fast/Edge Port

In Ethernet networks, only one active path may exist between any two bridges or switches. Multiple active paths between switches can cause loops in the network. When loops occur, some switches recognize stations on both sides of the switch. This situation causes the forwarding algorithm to malfunction allowing duplicate frames to be forwarded. Spanning tree algorithms provide path redundancy by defining a tree that spans all of the switches in an extended network and then forces certain redundant data paths into a standby (blocked) state. At regular intervals, the switches in the network send and receive spanning tree packets that they use to identify the path. If one network segment becomes unreachable, or if spanning tree costs change, the spanning tree algorithm reconfigures the spanning tree topology and re-establishes the link by activating the standby path. Spanning tree operation is transparent to end stations, which do not detect whether they are connected to a single LAN segment or a switched LAN of multiple segments.

Spanning Tree Protocol (STP) is a Layer 2 protocol designed to run on bridges and switches. The specification for STP is defined in IEEE 802.1d. The main purpose of STP is to ensure that you do not run into a loop situation when you have redundant paths in your network. STP detects/disables network loops and provides backup links between switches or bridges. It allows the device to interact with other STP compliant devices in your network to ensure that only one path exists between any two stations on the network.

After a stable network topology has been established, all bridges listen for hello BPDUs (Bridge Protocol Data Units) transmitted from the root bridge. If a bridge does not get a hello BPDU after a predefined interval (Max Age), the bridge assumes that the link to the root bridge is down. This bridge then initiates negotiations with other bridges to reconfigure the network to re-establish a valid network topology. The process to create a new topology can take up to 50 seconds. During this time, end-to-end communications are interrupted.

The use of Spanning Tree is not recommended for ports that are connected to end stations, because by definition, an end station does not create a loop within an Ethernet segment. Additionally, when a teamed adapter is connected to a port with Spanning Tree enabled, users may experience unexpected connectivity problems. For example, consider a teamed adapter

that has a lost link on one of its physical adapters. If the physical adapter were to be reconnected (also known as fallback), the intermediate driver would detect that the link has been reestablished and would begin to pass traffic through the port. Traffic would be lost if the port was temporarily blocked by the Spanning Tree Protocol.

Topology Change Notice (TCN)

A bridge/switch creates a forwarding table of MAC addresses and port numbers by learning the source MAC address that received on a particular port. The table is used to forward frames to a specific port rather than flooding the frame to all ports. The typical maximum aging time of entries in the table is 5 minutes. Only when a host has been silent for 5 minutes would its entry be removed from the table. It is sometimes beneficial to reduce the aging time. One example is when a forwarding link goes to blocking and a different link goes from blocking to forwarding. This change could take up to 50 seconds. At the end of the STP re-calculation a new path would be available for communications between end stations. However, because the forwarding table would still have entries based on the old topology, communications may not be reestablished until after 5 minutes when the affected ports entries are removed from the table. Traffic would then be flooded to all ports and re-learned. In this case it is beneficial to reduce the aging time. This is the purpose of a topology change notice (TCN) BPDU. The TCN is sent from the affected bridge/switch to the root bridge/switch. As soon as a bridge/switch detects a topology change (a link going down or a port going to forwarding) it sends a TCN to the root bridge via its root port. The root bridge then advertises a BPDU with a Topology Change to the entire network. This causes every bridge to reduce the MAC table aging time to 15 seconds for a specified amount of time. This allows the switch to re-learn the MAC addresses as soon as STP re-converges.

Topology Change Notice BPDUs are sent when a port that was forwarding changes to blocking or transitions to forwarding. A TCN BPDU does not initiate an STP recalculation. It only affects the aging time of the forwarding table entries in the switch. It will not change the topology of the network or create loops. End nodes such as servers or clients trigger a topology change when they power off and then power back on.

Port Fast/Edge Port

To reduce the effect of TCNs on the network (for example, increasing flooding on switch ports), end nodes that are powered on/off often should use the Port Fast or Edge Port setting on the switch port they are attached to. Port Fast or Edge Port is a command that is applied to specific ports and has the following effects:

- Ports coming from link down to link up will be put in the forwarding STP mode instead of going from listening to learning and then to forwarding. STP is still running on these ports.
- The switch does not generate a Topology Change Notice when the port is going up or down.

Layer 3 Routing/Switching

The switch that the teamed ports are connected to must not be a Layer 3 switch or router. The ports in the team must be in the same network.

Teaming with Hubs (for troubleshooting purposes only)

- [Hub Usage in Teaming Network Configurations](#)
- [SLB Teams](#)
- [SLB Team Connected to a Single Hub](#)
- [Generic and Dynamic Trunking \(FEC/GEC/IEEE 802.3ad\)](#)

SLB teaming can be used with 10/100 hubs, but it is only recommended for troubleshooting purposes, such as connecting a network analyzer in the event that switch port mirroring is not an option.

Hub Usage in Teaming Network Configurations

Although the use of hubs in network topologies is functional in some situations, it is important to consider the throughput ramifications when doing so. Network hubs have a maximum of 100 Mbps half-duplex link speed, which severely degrades performance in either a Gigabit or 100 Mbps switched-network configuration. Hub bandwidth is shared among all connected devices; as a result, when more devices are connected to the hub, the bandwidth available to any single device connected to the hub is reduced in direct proportion to the number of devices connected to the hub.

It is not recommended to connect team members to hubs; only switches should be used to connect to teamed ports. An SLB team, however, can be connected directly to a hub for troubleshooting purposes. Other team types can result in a loss of connectivity if specific failures occur and should not be used with hubs.

SLB Teams

SLB teams are the only teaming type not dependant on switch configuration. The server intermediate driver handles the load balancing and fault tolerance mechanisms with no assistance from the switch. These elements of SLB make it the only team type that maintains failover and fallback characteristics when team ports are connected directly to a hub.

SLB Team Connected to a Single Hub

SLB teams configured as shown in [Figure 6](#) maintain their fault tolerance properties. Either server connection could potentially fail, and network functionality is maintained. Clients could be connected directly to the hub, and fault tolerance would still be maintained; server performance, however, would be degraded.

Figure 6: Team Connected to a Single Hub

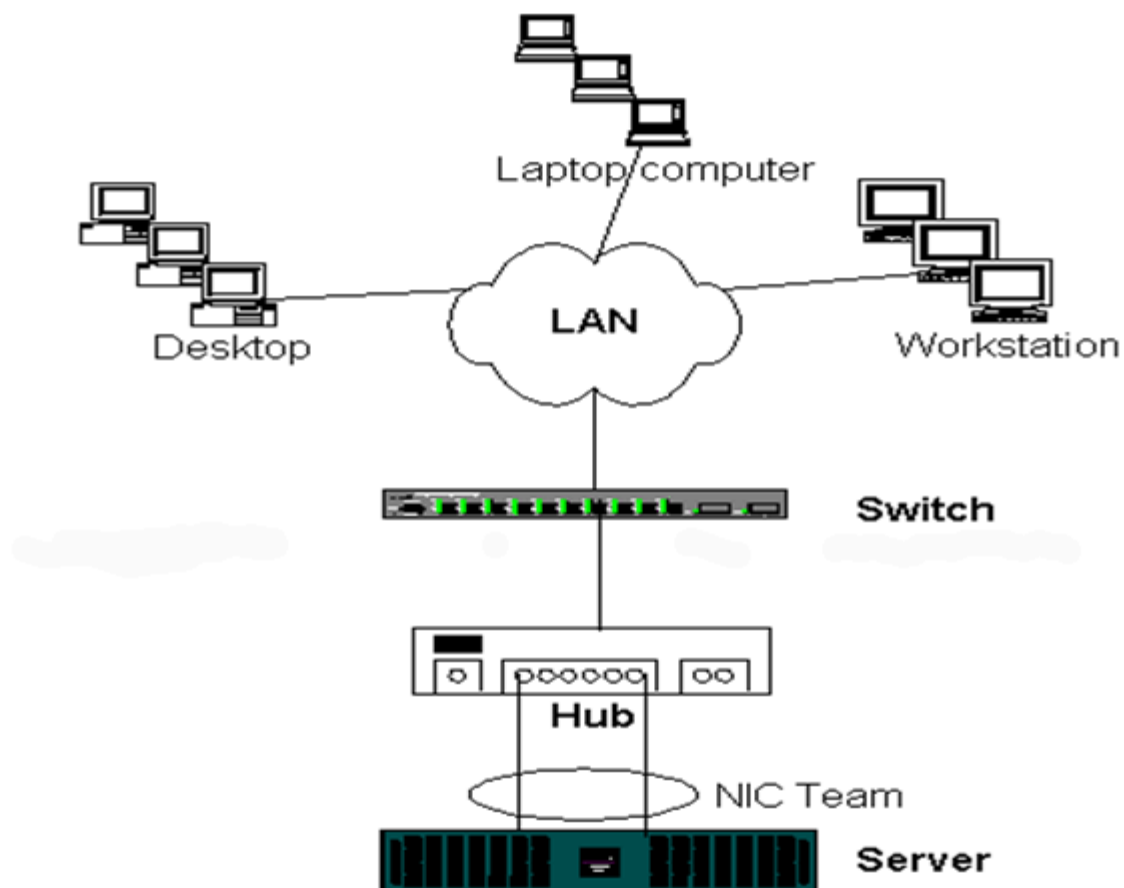

Generic and Dynamic Trunking (FEC/GEC/IEEE 802.3ad)

FEC/GEC and IEEE 802.3ad teams cannot be connected to any hub configuration. These team types must be connected to a switch that has also been configured for this team type.

Teaming with Microsoft NLB

Teaming *does not* work in Microsoft's Network Load Balancing (NLB) unicast mode, only in multicast mode. Due to the mechanism used by the NLB service, the recommended teaming configuration in this environment is Failover (SLB with a standby NIC) as load balancing is managed by NLB. The TOE functionality in teaming will not operate in NLB.

Application Considerations

Teaming and Clustering

- [Teaming and Network Backup](#)

Teaming and Clustering

- [Microsoft Cluster Software](#)
- [High-Performance Computing Cluster](#)
- [Oracle](#)

Microsoft Cluster Software

Dell Server cluster solutions integrate Microsoft Cluster Services (MSCS) with PowerVault SCSI or Dell/EMC Fibre-Channel based storage, Dell servers, storage adapters, storage switches and network adapters to provide high-availability (HA) solutions. HA clustering supports all adapters qualified on a supported Dell server.

In each cluster node, it is strongly recommended that customers install at least two network adapters (on-board adapters are acceptable). These interfaces serve two purposes. One adapter is used exclusively for intra-cluster *heartbeat* communications. This is referred to as the *private adapter* and usually resides on a separate private subnet. The other adapter is used for client communications and is referred to as the *public adapter*.

Multiple adapters may be used for each of these purposes: private, intracluster communications and public, external client communications. All Broadcom teaming modes are supported with Microsoft Cluster Software for the public adapter only. Private network adapter teaming is not supported. Microsoft indicates that the use of teaming on the private interconnect of a server cluster is not supported because of delays that could possibly occur in the transmission and receipt of heartbeat packets between the nodes. For best results, when you want redundancy for the private interconnect, disable teaming and use the available ports to form a second private interconnect. This achieves the same end result and provides dual, robust communication paths for the nodes to communicate over.

For teaming in a clustered environment, customers are recommended to use the same brand of adapters.

[Figure 7](#) shows a 2-node Fibre-Channel cluster with three network interfaces per cluster node: one private and two public. On each node, the two public adapters are teamed, and the private adapter is not. Teaming is supported across the same switch or across two switches. [Figure 8](#) shows the same 2-node Fibre-Channel cluster in this configuration.

Figure 7: Clustering With Teaming Across One Switch

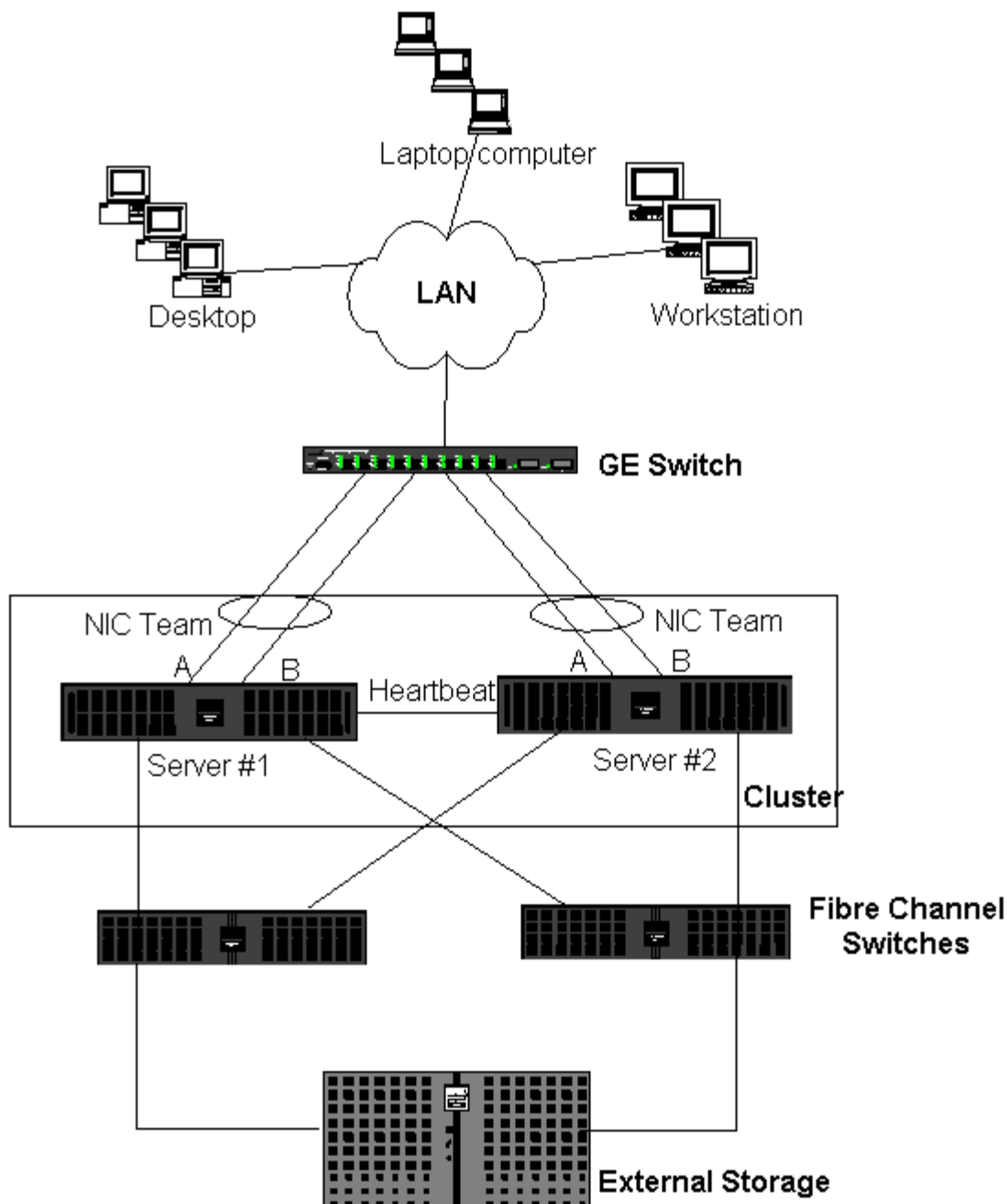

 NOTE: Microsoft Network Load Balancing is not supported with Microsoft Cluster Software.

High-Performance Computing Cluster

Gigabit Ethernet is typically used for the following three purposes in high-performance computing cluster (HPCC) applications:

- Inter-Process Communications (IPC): For applications that do not require low-latency, high-bandwidth interconnects (such as Myrinet, InfiniBand), Gigabit Ethernet can be used for communication between the compute nodes.
- I/O: Ethernet can be used for file sharing and serving the data to the compute nodes. This can be done simply using an NFS server or using parallel file systems such as PVFS.
- Management & Administration: Ethernet is used for out-of-band (ERA) and in-band (OMSA) management of the nodes in the cluster. It can also be used for job scheduling and monitoring.

In our current HPCC offerings, only one of the on-board adapters is used. If Myrinet or IB is present, this adapter serves I/O and administration purposes; otherwise, it is also responsible for IPC. In case of an adapter failure, the administrator can use the Felix package to easily configure adapter 2. Adapter teaming on the host side is neither tested nor supported in HPCC.

Advanced Features

PXE is used extensively for the deployment of the cluster (installation and recovery of compute nodes). Teaming is typically not used on the host side and it is not a part of our standard offering. Link aggregation is commonly used between switches, especially for large configurations. Jumbo frames, although not a part of our standard offering, may provide performance improvement for some applications due to reduced CPU overhead.

Oracle

In our Oracle Solution Stacks, we support adapter teaming in both the private network (interconnect between RAC nodes) and public network with clients or the application layer above the database layer.

Figure 8: Clustering With Teaming Across Two Switches

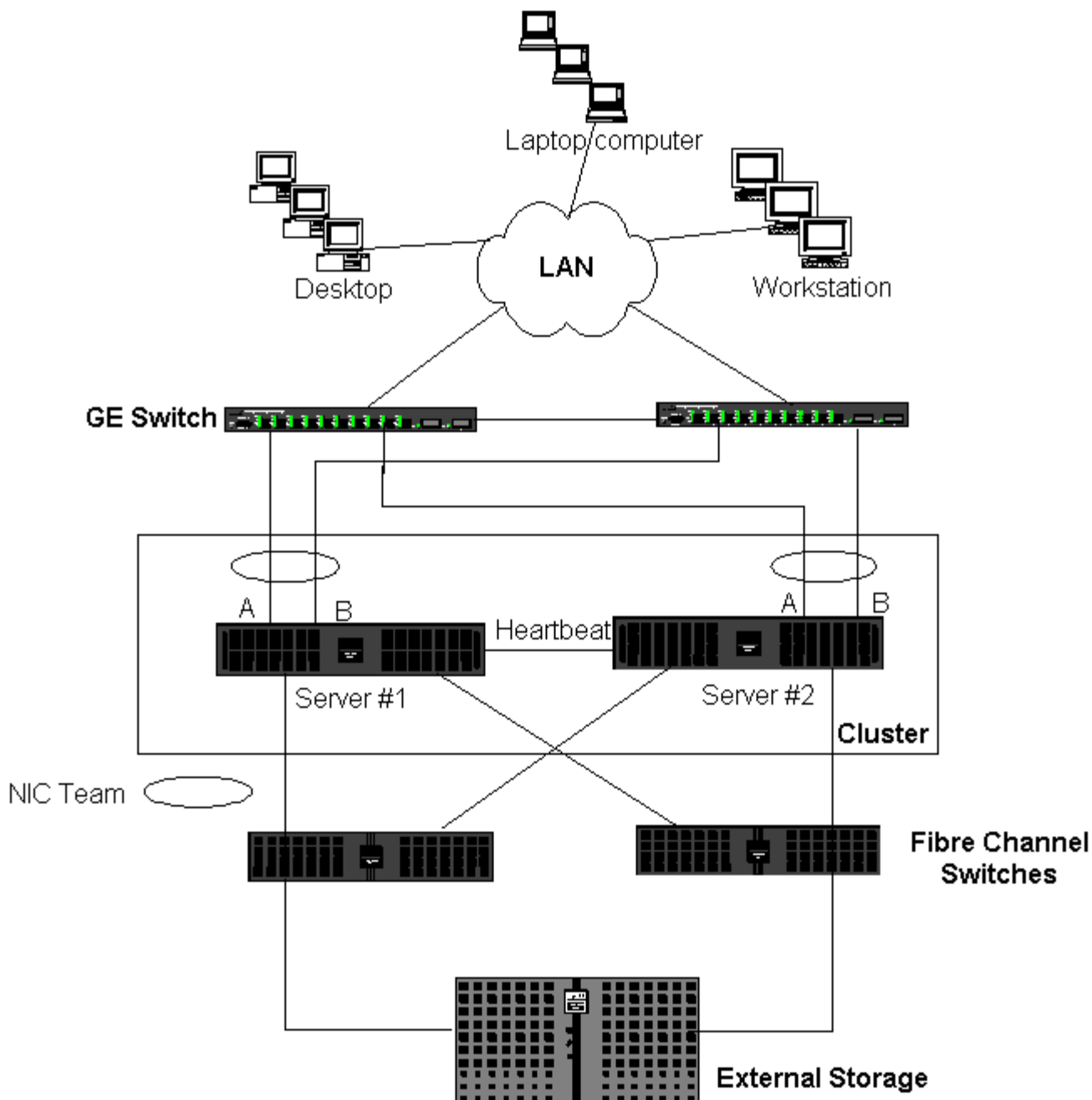

Teaming and Network Backup

- Load Balancing and Failover
- Fault Tolerance

When you perform network backups in a nonteamed environment, overall throughput on a backup server adapter can be easily impacted due to excessive traffic and adapter overloading. Depending on the number of backup servers, data streams, and tape drive speed, backup traffic can easily consume a high percentage of the network link bandwidth, thus impacting production data and tape backup performance. Network backups usually consist of a dedicated backup server running with tape backup software such as NetBackup, Galaxy or Backup Exec. Attached to the backup server is either a direct SCSI tape backup unit or a tape library connected through a fiber channel storage area network (SAN). Systems that are backed up over the network are typically called clients or remote servers and usually have a tape backup software agent installed.

Figure 9 shows a typical 1 Gbps nonteamed network environment with tape backup implementation.

Figure 9: Network Backup without Teaming

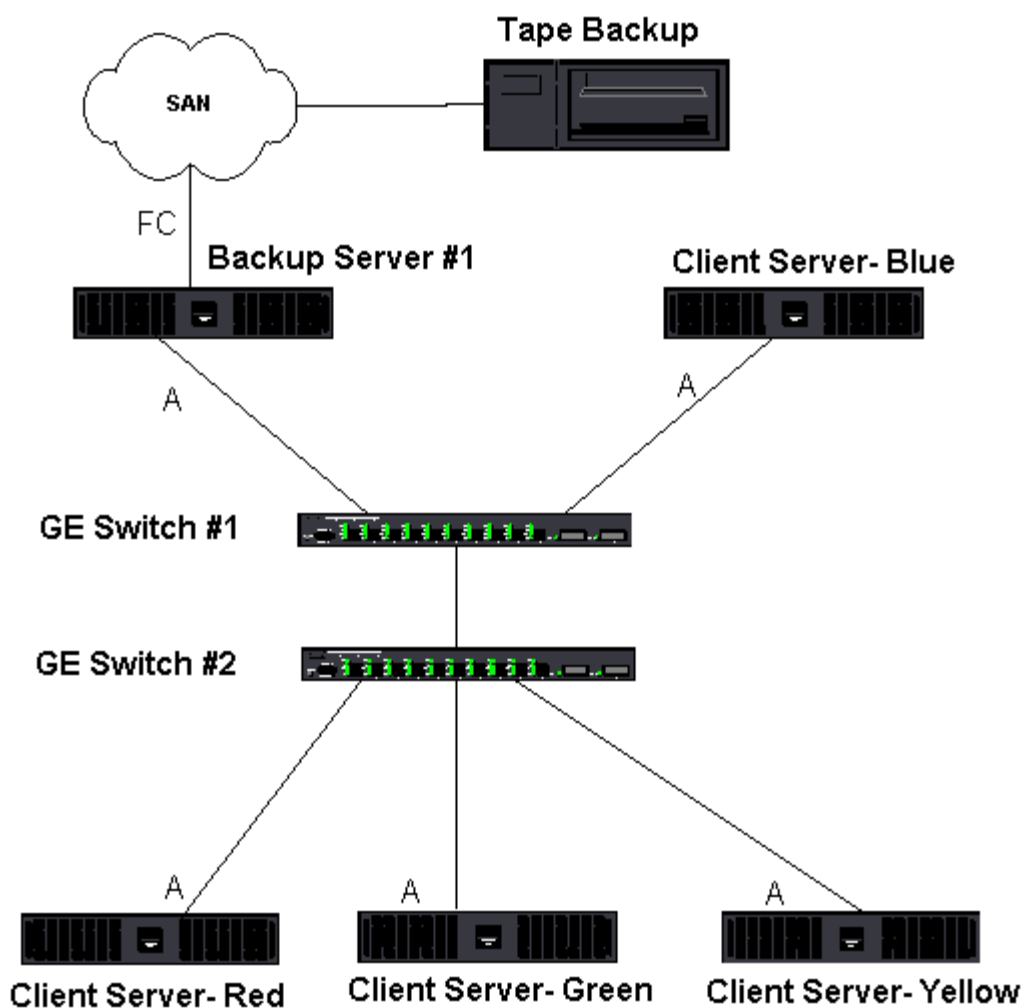

Because there are four client servers, the backup server can simultaneously stream four backup jobs (one per client) to a multidrive autoloader. Because of the single link between the switch and the backup server; however, a 4-stream backup can easily saturate the adapter and link. If the adapter on the backup server operates at 1 Gbps (125 MB/s), and each client is able to stream data at 20 MB/s during tape backup, the throughput between the backup server and switch will be at 80 MB/s (20 MB/s x 4), which is equivalent to 64% of the network bandwidth. Although this is well within the network bandwidth range, the 64% constitutes a high percentage, especially if other applications share the same link.

Load Balancing and Failover

As the number of backup streams increases, the overall throughput increases. Each data stream, however, may not be able to maintain the same performance as a single backup stream of 25 MB/s. In other words, even though a backup server can stream data from a single client at 25 MB/s, it is not expected that four simultaneously-running backup jobs will stream at 100 MB/s (25 MB/s x 4 streams). Although overall throughput increases as the number of backup streams increases, each backup stream can be impacted by tape software or network stack limitations.

For a tape backup server to reliably use adapter performance and network bandwidth when backing up clients, a network infrastructure must implement teaming such as load balancing and fault tolerance. Data centers will incorporate redundant switches, link aggregation, and trunking as part of their fault tolerant solution. Although teaming device drivers will manipulate the way data flows through teamed interfaces and failover paths, this is transparent to tape backup applications and does not interrupt any tape backup process when backing up remote systems over the network. [Figure 10](#) shows a network topology that demonstrates tape backup in a Broadcom teamed environment and how smart load balancing can *load balance* tape backup data across teamed adapters.

There are four paths that the client-server can use to send data to the backup server, but only one of these paths will be designated during data transfer. One possible path that Client-Server Red can use to send data to the backup server is:

Example Path: Client-Server Red sends data through Adapter A, Switch 1, Backup Server Adapter A.

The designated path is determined by two factors:

- Client-Server ARP cache; which points to the backup server MAC address. This is determined by the Broadcom intermediate driver inbound load balancing algorithm.
- The physical adapter interface on Client-Server Red will be used to transmit the data. The Broadcom intermediate driver outbound load balancing algorithm determines this (see [Outbound Traffic Flow](#) and [Inbound Traffic Flow \(SLB Only\)](#)).

The teamed interface on the backup server transmits a gratuitous address resolution protocol (G-ARP) to Client-Server Red, which in turn, causes the client server ARP cache to get updated with the Backup Server MAC address. The load balancing mechanism within the teamed interface determines the MAC address embedded in the G-ARP. The selected MAC address is essentially the destination for data transfer from the client server. On Client-Server Red, the SLB teaming algorithm will determine which of the two adapter interfaces will be used to transmit data. In this example, data from Client Server Red is received on the backup server Adapter A interface. To demonstrate the SLB mechanisms when additional load is placed on the teamed interface, consider the scenario when the backup server initiates a second backup operation: one to Client-Server Red, and one to Client-Server Blue. The route that Client-Server Blue uses to send data to the backup server is dependant on its ARP cache, which points to the backup server MAC address. Because Adapter A of the backup server is already under load from its backup operation with Client-Sever Red, the Backup Server invokes its SLB algorithm to *inform* Client-Server Blue (through an G-ARP) to update its ARP cache to reflect the backup server Adapter B MAC address. When Client-Server Blue needs to transmit data, it uses either one of its adapter interfaces, which is determined by its own SLB algorithm. What is important is that data from Client-Server Blue is received by the Backup Server Adapter B interface, and not by its Adapter A interface. This is important because with both backup streams running simultaneously, the backup server must *load balance* data streams from different clients. With both backup streams running, each adapter interface on the backup server is processing an equal load, thus load-balancing data across both adapter interfaces.

The same algorithm applies if a third and fourth backup operation is initiated from the backup server. The teamed interface on the backup server transmits a unicast G-ARP to backup clients to inform them to update their ARP cache. Each client then transmits backup data along a route to the target MAC address on the backup server.

Fault Tolerance

If a network link fails during tape backup operations, all traffic between the backup server and client stops and backup jobs fail. If, however, the network topology was configured for both Broadcom SLB and switch fault tolerance, then this would allow tape backup operations to continue without interruption during the link failure. All failover processes within the network are transparent to tape backup software applications. To understand how backup data streams are directed during network failover process, consider the topology in [Figure 10](#). Client-Server Red is transmitting data to the backup server through Path 1, but a link failure occurs between the backup server and the switch. Because the data can no longer be sent from Switch #1 to the Adapter A interface on the backup server, the data is redirected from Switch #1 through Switch #2, to the Adapter B interface on the backup server. This occurs without the knowledge of the backup application because all fault tolerant operations are handled by the adapter team interface and trunk settings on the switches. From the client server perspective, it still operates as if it is transmitting data through the original path.

Figure 10: Network Backup With SLB Teaming Across Two Switches

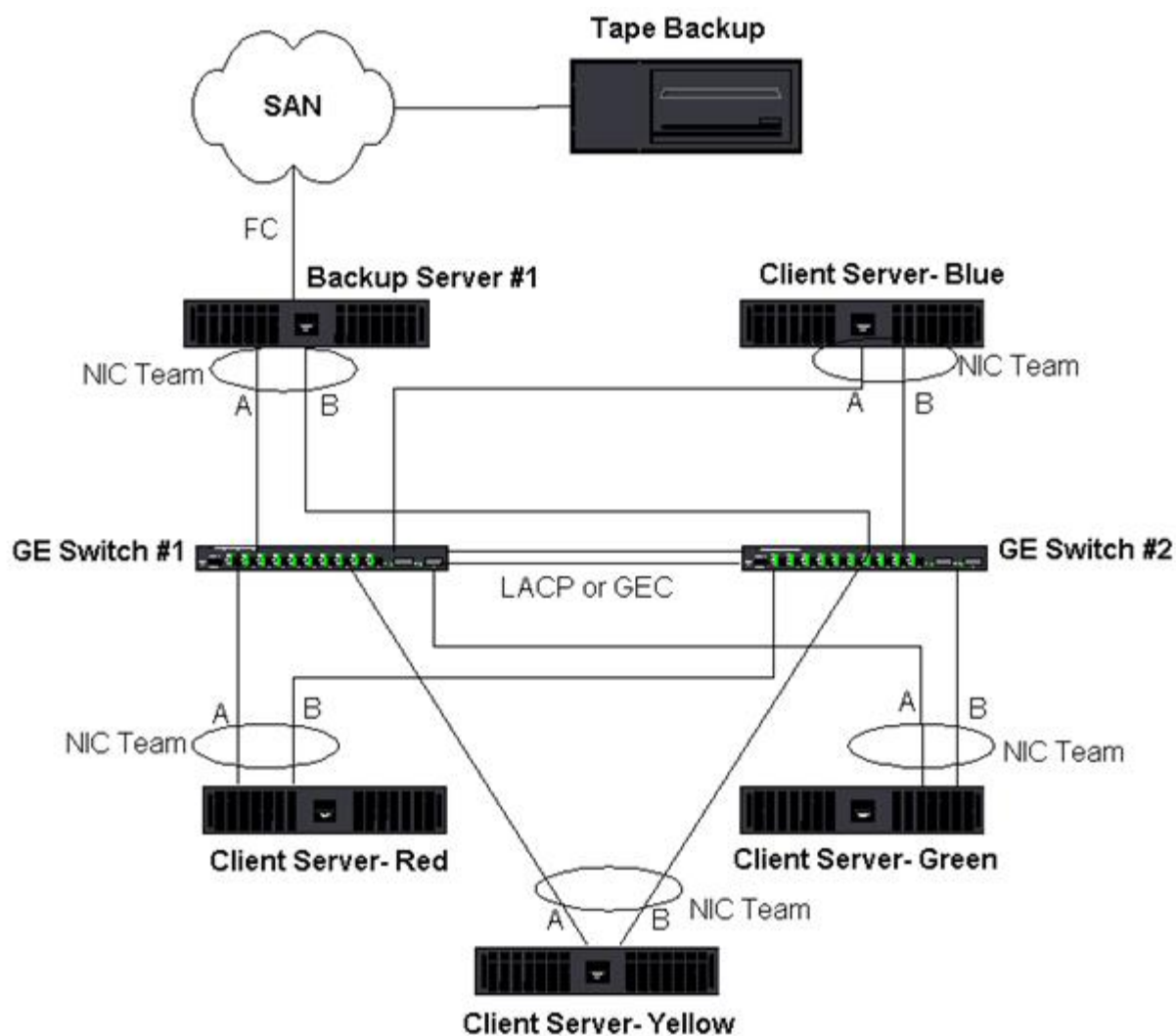

Troubleshooting Teaming Problems

- [Teaming Configuration Tips](#)
- [Troubleshooting Guidelines](#)

When running a protocol analyzer over a virtual adapter teamed interface, the MAC address shown in the transmitted frames may not be correct. The analyzer does not show the frames as constructed by BASP and shows the MAC address of the team and not the MAC address of the interface transmitting the frame. It is suggested to use the following process to monitor a team:

- Mirror all uplink ports from the team at the switch.
- If the team spans two switches, mirror the interlink trunk as well.
- Sample all mirror ports independently.
- On the analyzer, use an adapter and driver that does not filter QoS and VLAN information.

Teaming Configuration Tips

When troubleshooting network connectivity or teaming functionality issues, ensure that the following information is true for your configuration.

1. Although mixed-speed SLB teaming is supported by Dell, it is recommended that all adapters in a team be the same speed (either all Gigabit Ethernet or all Fast Ethernet). For speeds of 10 Gbps, it is highly recommended that all adapters in a team be the same speed.
2. If LiveLink is not enabled, disable Spanning Tree Protocol or enable an STP mode that bypasses the initial phases (for

- example, Port Fast, Edge Port) for the switch ports connected to a team.
3. All switches that the team is directly connected to must have the same hardware revision, firmware revision, and software revision to be supported.
 4. To be teamed, adapters should be members of the same VLAN. In the event that multiple teams are configured, each team should be on a separate network.
 5. Do not assign a Locally Administered Address on any physical adapter that is a member of a team.
 6. Verify that power management is disabled on all physical members of any team.
 7. Remove any static IP address from the individual physical team members before the team is built.
 8. A team that requires maximum throughput should use LACP or GEC\FEC. In these cases, the intermediate driver is only responsible for the outbound load balancing while the switch performs the inbound load balancing.
 9. Aggregated teams (802.3ad \ LACP and GEC\FEC) must be connected to only a single switch that supports IEEE 802.3a, LACP or GEC/FEC.
 10. It is not recommended to connect any team to a hub, as hubs only support half duplex. Hubs should be connected to a team for troubleshooting purposes only. Disabling the device driver of a network adapter participating in an LACP or GEC/FEC team may have adverse affects with network connectivity. Broadcom recommends that the adapter first be physically disconnected from the switch before disabling the device driver in order to avoid a network connection loss.
 11. Verify the base (Miniport) and team (intermediate) drivers are from the same release package. Dell does not test or support mixing base and teaming drivers from different releases.
 12. Test the connectivity to each physical adapter prior to teaming.
 13. Test the failover and fallback behavior of the team before placing into a production environment.
 14. When moving from a nonproduction network to a production network, it is strongly recommended to test again for failover and fallback.
 15. Test the performance behavior of the team before placing into a production environment.
 16. Network teaming is not supported when running iSCSI traffic via Microsoft iSCSI initiator or iSCSI offload. MPIO should be used instead of Broadcom network teaming for these ports.
 17. For information on iSCSI boot and iSCSI offload restrictions, see [iSCSI Protocol](#).

Troubleshooting Guidelines

Before you call Dell support, make sure you have completed the following steps for troubleshooting network connectivity problems when the server is using adapter teaming.

1. Make sure the link light is ON for every adapter and all the cables are attached.
2. Check that the matching base and intermediate drivers belong to the same Dell release and are loaded correctly.
3. Check for a valid IP Address using the Windows ipconfig command.
4. Check that STP is disabled or Edge Port/Port Fast is enabled on the switch ports connected to the team or that LiveLink is being used.
5. Check that the adapters and the switch are configured identically for link speed and duplex.
6. If possible, break the team and check for connectivity to each adapter independently to confirm that the problem is directly associated with teaming.
7. Check that all switch ports connected to the team are on the same VLAN.
8. Check that the switch ports are configured properly for Generic Trunking (FEC/GEC)/802.3ad-Draft Static type of teaming and that it matches the adapter teaming type. If the system is configured for an SLB type of team, make sure the corresponding switch ports *are not* configured for Generic Trunking (FEC/GEC)/802.3ad-Draft Static types of teams.

Frequently Asked Questions

Question: Under what circumstances is traffic not load balanced? Why is all traffic not load balanced evenly across the team members?

Answer: The bulk of traffic does not use IP/TCP/UDP or the bulk of the clients are in a different network. The receive load balancing is not a function of traffic load, but a function of the number of clients that are connected to the server.

Question: What network protocols are load balanced when in a team?

Answer: Broadcom's teaming software only supports IP/TCP/UDP traffic. All other traffic is forwarded to the primary adapter.

Question: Which protocols are load balanced with SLB and which ones are not?

Answer: Only IP/TCP/UDP protocols are load balanced in both directions: send and receive. IPX is load balanced on the transmit traffic only.

Question: Can I team a port running at 100 Mbps with a port running at 1000 Mbps?

Answer: Mixing link speeds within a team is only supported for Smart Load Balancing™ teams and 802.3ad teams.

Question: Can I team a fiber adapter with a copper Gigabit Ethernet adapter?

Answer: Yes with SLB, and yes if the switch allows for it in FEC/GEC and 802.3ad.

Question: What is the difference between adapter load balancing and Microsoft's Network Load Balancing (NLB)?

Answer: Adapter load balancing is done at a network session level, whereas NLB is done at the server application level.

Question: Can I connect the teamed adapters to a hub?

Answer: Teamed ports can be connected to a hub for troubleshooting purposes only. However, this practice is not recommended for normal operation because the performance would be degraded due to hub limitations. Connect the teamed ports to a switch instead.

Question: Can I connect the teamed adapters to ports in a router?

Answer: No. All ports in a team must be on the same network; in a router, however, each port is a separate network by definition. All teaming modes require that the link partner be a Layer 2 switch.

Question: Can I use teaming with Microsoft Cluster Services?

Answer: Yes. Teaming is supported on the public network only, not on the private network used for the heartbeat link.

Question: Can PXE work over a virtual adapter (team)?

Answer: A PXE client operates in an environment before the operating system is loaded; as a result, virtual adapters have not been enabled yet. If the physical adapter supports PXE, then it can be used as a PXE client, whether or not it is part of a virtual adapter when the operating system loads. PXE servers may operate over a virtual adapter.

Question: Can WOL work over a virtual adapter (team)?

Answer: Wake-on-LAN functionality operates in an environment before the operating system is loaded. WOL occurs when the system is off or in standby, so no team is configured.

Question: What is the maximum number of ports that can be teamed together?

Answer: Up to eight ports can be assigned to a team.

Question: What is the maximum number of teams that can be configured on the same server?

Answer: Up to 16 teams can be configured on the same server.

Question: Why does my team lose connectivity for the first 30 to 50 seconds after the Primary adapter is restored (fallback)?

Answer: Because Spanning Tree Protocol is bringing the port from blocking to forwarding. You must enable Port Fast or Edge Port on the switch ports connected to the team or use LiveLink to account for the STP delay.

Question: Can I connect a team across multiple switches?

Answer: Smart Load Balancing can be used with multiple switches because each physical adapter in the system uses a unique Ethernet MAC address. Link Aggregation and Generic Trunking cannot operate across switches because they require all physical adapters to share the same Ethernet MAC address.

Question: How do I upgrade the intermediate driver (BASP)?

Answer: The intermediate driver cannot be upgraded through the Local Area Connection Properties. It must be upgraded using the Setup installer.

Question: How can I determine the performance statistics on a virtual adapter (team)?

Answer: In Broadcom Advanced Control Suite, click the Statistics tab for the virtual adapter.

Question: Can I configure NLB and teaming concurrently?

Answer: Yes, but only when running NLB in a multicast mode (NLB is not supported with MS Cluster Services).

Question: Should both the backup server and client servers that are backed up be teamed?

Answer: Because the backup server is under the most data load, it should always be teamed for link aggregation and failover. A fully redundant network, however, requires that both the switches and the backup clients be teamed for fault tolerance and link aggregation.

Question: During backup operations, does the adapter teaming algorithm load balance data at a byte-level or a session-level?

Answer: When using adapter teaming, data is only load balanced at a session level and not a byte level to prevent out-of-

order frames. Adapter teaming load balancing does not work the same way as other storage load balancing mechanisms such as EMC PowerPath.

Question: Is there any special configuration required in the tape backup software or hardware to work with adapter teaming?

Answer: No special configuration is required in the tape software to work with teaming. Teaming is transparent to tape backup applications.

Question: How do I know what driver I am currently using?

Answer: In all operating systems, the most accurate method for checking the driver revision is to physically locate the driver file and check the properties.

Question: Can SLB detect a switch failure in a Switch Fault Tolerance configuration?

Answer: No. SLB can only detect the loss of link between the teamed port and its immediate link partner. SLB cannot detect link failures on other ports.

Question: Where can I get the latest supported drivers?

Answer: Go to Dell support at <http://support.dell.com> for driver package updates or support documents.

Question: Why does my team lose connectivity for the first 30 to 50 seconds after the primary adapter is restored (fall-back after a failover)?

Answer: During a fall-back event, link is restored causing Spanning Tree Protocol to configure the port for blocking until it determines that it can move to the forwarding state. You must enable Port Fast or Edge Port on the switch ports connected to the team to prevent the loss of communications caused by STP.

Question: Where do I monitor real time statistics for an adapter team in a Windows server?

Answer: Use the Broadcom Advanced Control Suite (BACS) to monitor general, IEEE 802.3 and custom counters.

Question: What features are not supported on a multivendor team?

Answer: TOE, VLAN tagging, and RSS are not supported on a multivendor team.

Appendix A: Event Log Messages

- [Windows System Event Log Messages](#)
- [Base Driver \(Physical Adapter/Miniport\)](#)
- [Intermediate Driver \(Virtual Adapter/Team\)](#)
- [Virtual Bus Driver \(VBD\)](#)

Windows System Event Log Messages

The known base and intermediate Windows System Event Log status messages for the Broadcom NetXtreme II adapters are listed in [Table 8](#) and [Table 9](#). As a Broadcom adapter driver loads, Windows places a status code in the system event viewer. There may be up to two classes of entries for these event codes depending on whether both drivers are loaded (one set for the base or miniport driver and one set for the intermediate or teaming driver).

Base Driver (Physical Adapter/Miniport)

The base driver is identified by source **L2ND**. [Table 8](#) lists the event log messages supported by the base driver, explains the cause for the message, and provides the recommended action.

 Note: In [Table 8](#), message numbers 1 through 17 apply to both NDIS 5.x and NDIS 6.x drivers, message numbers 18 through 23 apply only to the NDIS 6.x driver.

Table 8: Base Driver Event Log Messages

Message Number	Severity	Message	Cause	Corrective Action
1	Error	Failed to allocate memory for the device block. Check system memory resource	The driver cannot allocate memory from the operating system.	Close running applications to free memory.

		usage.		
2	Error	Failed to allocate map registers.	The driver cannot allocate map registers from the operating system.	Unload other drivers that may allocate map registers.
3	Error	Failed to access configuration information. Reinstall the network driver.	The driver cannot access PCI configuration space registers on the adapter.	For add-in adapters: reseat the adapter in the slot, move the adapter to another PCI slot, or replace the adapter.
4	Warning	The network link is down. Check to make sure the network cable is properly connected.	The adapter has lost its connection with its link partner.	Check that the network cable is connected, verify that the network cable is the right type, and verify that the link partner (for example, switch or hub) is working correctly.
5	Informational	The network link is up.	The adapter has established a link.	No action is required.
6	Informational	Network controller configured for 10Mb half-duplex link.	The adapter has been manually configured for the selected line speed and duplex settings.	No action is required.
7	Informational	Network controller configured for 10Mb full-duplex link.	The adapter has been manually configured for the selected line speed and duplex settings.	No action is required.
8	Informational	Network controller configured for 100Mb half-duplex link.	The adapter has been manually configured for the selected line speed and duplex settings.	No action is required.
9	Informational	Network controller configured for 100Mb full-duplex link.	The adapter has been manually configured for the selected line speed and duplex settings.	No action is required.
10	Informational	Network controller configured for 1Gb half-duplex link.	The adapter has been manually configured for the selected line speed and duplex settings.	No action is required.
11	Informational	Network controller configured for 1Gb full-duplex link.	The adapter has been manually configured for the selected line speed and duplex settings.	No action is required.
12	Informational	Network controller configured for 2.5Gb full-duplex link.	The adapter has been manually configured for the selected line speed and duplex settings.	No action is required.
13	Error	Medium not supported.	The operating system does not support the IEEE 802.3 medium.	Reboot the operating system, run a virus check, run a disk check (chkdsk), and reinstall the operating system.
14	Error	Unable to register the interrupt service routine.	The device driver cannot install the interrupt handler.	Reboot the operating system; remove other device drivers that may be sharing the same IRQ.
15	Error	Unable to map IO space.	The device driver cannot allocate memory-mapped I/O to access driver registers.	Remove other adapters from the system, reduce the amount of physical memory installed, and replace the adapter.
16	Informational	Driver initialized successfully.	The driver has successfully loaded.	No action is required.
17	Informational	NDIS is resetting the miniport driver.	The NDIS layer has detected a problem sending/receiving packets and is resetting the driver to resolve the problem.	Run Broadcom Advanced Control Suite diagnostics; check that the network cable is good.
18	Error	Unknown PHY detected. Using a default PHY initialization routine.	The driver could not read the PHY ID.	Replace the adapter.

19	Error	This driver does not support this device. Upgrade to the latest driver.	The driver does not recognize the installed adapter.	Upgrade to a driver version that supports this adapter.
20	Error	Driver initialization failed.	Unspecified failure during driver initialization.	Reinstall the driver, update to a newer driver, run Broadcom Advanced Control Suite diagnostics, or replace the adapter.
21	Informational	Network controller configured for 10Gb full-duplex link.	The adapter has been manually configured for the selected line speed and duplex settings.	No action is required.
22	Error	Network controller failed initialization because it cannot allocate system memory.	Insufficient system memory prevented the initialization of the driver.	Increase system memory.
23	Error	Network controller failed to exchange the interface with the bus driver.	The driver and the bus driver are not compatible.	Update to the latest driver set, ensuring the major and minor versions for both NDIS and the bus driver are the same.

Intermediate Driver (Virtual Adapter/Team)

The intermediate driver is identified by source **BLFM**, regardless of the base driver revision. [Table 9](#) lists the event log messages supported by the intermediate driver, explains the cause for the message, and provides the recommended action.

Table 9: Intermediate Driver Event Log Messages

System Event Message Number	Severity	Message	Cause	Corrective Action
1	Informational	Event logging enabled for Broadcom Advanced Server Program driver.	–	No action is required.
2	Error	Unable to register with NDIS.	The driver cannot register with the NDIS interface.	Unload other NDIS drivers.
3	Error	Unable to instantiate the management interface.	The driver cannot create a device instance.	Reboot the operating system.
4	Error	Unable to create symbolic link for the management interface.	Another driver has created a conflicting device name.	Unload the conflicting device driver that uses the name <i>BIf</i> .
5	Informational	Broadcom Advanced Server Program Driver has started.	The driver has started.	No action is required.
6	Informational	Broadcom Advanced Server Program Driver has stopped.	The driver has stopped.	No action is required.
7	Error	Could not allocate memory for internal data structures.	The driver cannot allocate memory from the operating system.	Close running applications to free memory.
8	Warning	Could not bind to adapter.	The driver could not open one of the team physical adapters.	Unload and reload the physical adapter driver, install an updated physical adapter driver, or replace the physical adapter.
9	Informational	Successfully bind to adapter.	The driver successfully opened the physical adapter.	No action is required.
10	Warning	Network adapter is disconnected.	The physical adapter is not connected to the network (it has not established link).	Check that the network cable is connected, verify that the network cable is the right type, and verify that the link partner (switch or hub) is working correctly.

11	Informational	Network adapter is connected.	The physical adapter is connected to the network (it has established link).	No action is required.
12	Error	Broadcom Advanced Program Features Driver is not designed to run on this version of Operating System.	The driver does not support the operating system on which it is installed.	Consult the driver release notes and install the driver on a supported operating system or update the driver.
13	Informational	Hot-standby adapter is selected as the primary adapter for a team without a load balancing adapter.	A standby adapter has been activated.	Replace the failed physical adapter.
14	Informational	Network adapter does not support Advanced Failover.	The physical adapter does not support the Broadcom NIC Extension (NICE).	Replace the adapter with one that does support NICE.
15	Informational	Network adapter is enabled via management interface.	The driver has successfully enabled a physical adapter through the management interface.	No action is required.
16	Warning	Network adapter is disabled via management interface.	The driver has successfully disabled a physical adapter through the management interface.	No action is required.
17	Informational	Network adapter is activated and is participating in network traffic.	A physical adapter has been added to or activated in a team.	No action is required.
18	Informational	Network adapter is de-activated and is no longer participating in network traffic.	The driver does not recognize the installed adapter.	No action is required.
19	Informational	The LiveLink feature in BASP connected the link for the network adapter.	The connection with the remote target(s) for the LiveLink-enabled team member has been established or restored	No action is required.
20	Informational	The LiveLink feature in BASP disconnected the link for the network adapter.	The LiveLink-enabled team member is unable to connect with the remote target(s).	No action is required.

Virtual Bus Driver (VBD)

Table 10: Virtual Bus Driver (VBD) Event Log Messages

Message Number	Severity	Message	Cause	Corrective Action
1	Error	Failed to allocate memory for the device block. Check system memory resource usage.	The driver cannot allocate memory from the operating system.	Close running applications to free memory.
2	Informational	The network link is down. Check to make sure the network cable is properly connected.	The adapter has lost its connection with its link partner.	Check that the network cable is connected, verify that the network cable is the right type, and verify that the link partner (for example, switch or hub) is working correctly.
3	Informational	The network link is up.	The adapter has established a link.	No action is required.
4	Informational	Network controller configured for 10Mb half-duplex link.	The adapter has been manually configured for the selected line speed and duplex settings.	No action is required.
		Network controller	The adapter has been	

5	Informational	configured for 10Mb full-duplex link.	manually configured for the selected line speed and duplex settings.	No action is required.
6	Informational	Network controller configured for 100Mb half-duplex link.	The adapter has been manually configured for the selected line speed and duplex settings.	No action is required.
7	Informational	Network controller configured for 100Mb full-duplex link.	The adapter has been manually configured for the selected line speed and duplex settings.	No action is required.
8	Informational	Network controller configured for 1Gb half-duplex link.	The adapter has been manually configured for the selected line speed and duplex settings.	No action is required.
9	Informational	Network controller configured for 1Gb full-duplex link.	The adapter has been manually configured for the selected line speed and duplex settings.	No action is required.
10	Error	Unable to register the interrupt service routine.	The device driver cannot install the interrupt handler.	Reboot the operating system; remove other device drivers that may be sharing the same IRQ.
11	Error	Unable to map IO space.	The device driver cannot allocate memory-mapped I/O to access driver registers.	Remove other adapters from the system, reduce the amount of physical memory installed, and replace the adapter.
12	Informational	Driver initialized successfully.	The driver has successfully loaded.	No action is required.
13	Error	Driver initialization failed.	Unspecified failure during driver initialization.	Reinstall the driver, update to a newer driver, run Broadcom Advanced Control Suite diagnostics, or replace the adapter.
14	Error	This driver does not support this device. Upgrade to the latest driver.	The driver does not recognize the installed adapter.	Upgrade to a driver version that supports this adapter.
15	Error	This driver fails initialization because the system is running out of memory.	Insufficient system memory prevented the initialization of the driver.	Increase system memory.

Please read all [Restrictions and Disclaimers](#).

[Back to Contents Page](#)

[Back to Contents Page](#)

NIC Partitioning: Broadcom NetXtreme II® Network Adapter User Guide

- [Overview](#)
- [Configuring for NIC Partitioning](#)

Overview

NIC partitioning (NPAR) divides a Broadcom NetXtreme II 10 Gigabit Ethernet NIC into multiple virtual NICs by having multiple PCI physical functions per port. Each PCI function is associated with a different virtual NIC. To the OS and the network, each physical function appears as a separate NIC port.

 NOTE: Link speed cannot be configured for 1 Gbps when NPAR is enabled.

The number of partitions for each port is from one to four; thus, making a dual-port NIC capable of a maximum of eight partitions. Each partition behaves as if it is an independent NIC port.

 NOTE: On dual-port adapters:

- The 1G ports do not support NPAR.
- On 10G ports, only two functions per port are supported.

Benefits of a partitioned 10G NIC include:

- Reduced cabling and ports when used to replace many 1G NICs.
- Server segmentation with separate subnets/VLANs.
- High server availability with NIC failover and NIC link bandwidth aggregation.
- Server I/O virtualization with a virtual OS and monolithic OS support.
- Changes to the OS is not required.
- SLB type teaming is supported.

Supported Operating Systems for NIC Partitioning

The Broadcom NetXtreme II 10 Gigabit Ethernet adapters support NIC partitioning on the following operating systems:

- Windows Server 2008 family
- Windows Server 2012 family
- Linux 64-bit, RHEL 5.5 and later, SLES11 SP1 and later
- VMware ESX, ESXi 4.1, ESXi 5.0, and ESXi 5.1.

 NOTE: 32-bit Linux operating systems have a limited amount of memory space available for Kernel data structures. Therefore, it is recommended that only 64-bit Linux be used when configuring NPAR.

Configuring for NIC Partitioning

When NIC partitioning is enabled on an adapter, by default, only TCP Offload Engine (TOE) offloads are configured on each physical function (PF). You must explicitly configure storage offloads on a PF to use FCoE and iSCSI offload functionality on an adapter.

NIC partitioning can be configured using Broadcom's Comprehensive Configuration Management (CCM) utility. Some vendors provide a proprietary utility to configure NPAR. If this is the case, refer to the vendor-provided documentation for information on configuring NPAR on Broadcom NetXtreme II-10 Gigabit Ethernet adapters.

 **NOTE:** In NPAR mode, SR-IOV cannot be enabled on any PF on which storage offload (FCoE or iSCSI) is configured. This does not apply to adapters in Single Function (SF) mode.

To configure a NIC for partitioning using the CCM utility

1. Select the NIC from **Device List**.
2. From the **Main Menu**, select **Device Hardware Configuration**.
3. Change the **Multi-Function Mode** to **NPAR**.
4. Configure the NIC parameters for your configuration based on the options shown in [Table 1](#).

[Table 1](#) lists the configuration parameters available from the **NIC Partitioning Configuration** screen.

Table 1: Configuration Options

Parameter	Description	Options
Flow Control	Configures the Flow Control mode for this port.	<ul style="list-style-type: none"> • Auto • TX Flow Control • RX Flow Control • TX/RX Flow Control • None
PF#0, PF#2, PF#4, PF#6	Displays the physical function (PF) information regarding the partition(s) on port 0. Select to configure.	See Table 2 for configuration options.
PF#1, PF#3, PF#5, PF#7	Displays the physical function (PF) information regarding the partition(s) on port 1. Select to configure.	See Table 2 for configuration options.
Reset Configuration to Default	Resets the NIC partition configuration to the factory default settings.	

[Table 2](#) describes the functions available from the **PF# X** screen.

Table 2: Function Description

Function	Description	Option
Ethernet Protocol	Enables/disables Ethernet protocol.	<ul style="list-style-type: none"> • Enable • Disable
iSCSI Offload Protocol	Enables/disables iSCSI protocol.	<ul style="list-style-type: none"> • Enable • Disable
FCoE Offload protocol	Enables/disables FCoE protocol.	<ul style="list-style-type: none"> • Enable • Disable
Bandwidth Weight	Configures the weight or importance of a particular function. There are four functions per port and the weight is used to arbitrate between the functions in case of congestion.	The sum of all weights for the four functions are either 0 or 100.
Maximum Bandwidth	Configures the maximum bandwidth (in percentage) of the physical port link.	
Network MAC Address	Displays the network MAC address.	
iSCSI MAC Address	Displays the iSCSI MAC address.	
FCoE FIP MAC Address	Displays the FCoE MAC address.	

FCoE WWPN	FCoE World Wide Port Name.	
FCoE WWNN	FCoE World Wide Node Name.	
Note: Ensure that the Network MAC Address and the iSCSI MAC Address are not the same.		

Configuring equal **Bandwidth Weight** values for all functions has different effects depending on the actual values used for configuration. For example, when all functions are configured as "0" or "25", offloads configured on these functions exhibit different bandwidth settings even though, logically, they would be expected to have the same effect. Consider the following example:

Assume that four functions are configured with total six offloads, as follows.

Function 0

- Ethernet
- FCoE

Function 1

- Ethernet

Function 2

- Ethernet

Function 3

- Ethernet
- iSCSI
- If **Bandwidth Weight** is configured as "0" for all four PFs, then all six offloads will share the bandwidth equally. In this case, each offload will be assigned roughly 16.67% of the total bandwidth.
- If **Bandwidth Weight** is configured as "25" for all four PFs, then Ethernet & FCoE offloads on function 0 and Ethernet & iSCSI offloads on function 3 will be assigned roughly 12.5% of the total bandwidth. Ethernet offloads on function 1 and function 2, on the other hand, will be assigned roughly 25% of the total bandwidth.

 NOTE: Some vendors put restriction on minimum Bandwidth Weight that can be configured for each function. Please refer vendor specific documentation for details.

Please read all [Restrictions and Disclaimers](#).

[Back to Contents Page](#)

[Back to Contents Page](#)

Fibre Channel Over Ethernet: Broadcom NetXtreme II® Network Adapter User Guide

- [Overview](#)
- [FCoE Boot from SAN](#)
- [Configuring FCoE](#)

Overview

In today's data center, multiple networks, including network attached storage (NAS), management, IPC, and storage, are used to achieve the desired performance and versatility. In addition to iSCSI for storage solutions, Fibre Channel over Ethernet (FCoE) can now be used with capable Broadcom C-NICs. FCoE is a standard that allows Fibre Channel protocol to be transferred over Ethernet by preserving existing Fibre Channel infrastructures and capital investments by classifying received FCoE and FCoE Initialization Protocol (FIP) frames.

The following FCoE features are supported:

- Receiver classification of FCoE and FIP frames. FIP is the FCoE Initialization Protocol used to establish and maintain connections.
- Receiver CRC offload
- Transmitter CRC offload
- Dedicated queue set for Fibre Channel traffic
- Data Center Bridging (DCB) provides lossless behavior with Priority Flow Control (PFC)
- DCB allocates a share of link bandwidth to FCoE traffic with Enhanced Transmission Selection (ETS)

DCB supports storage, management, computing, and communications fabrics onto a single physical fabric that is simpler to deploy, upgrade, and maintain than in standard Ethernet networks. DCB technology allows the capable Broadcom C-NICs to provide lossless data delivery, lower latency, and standards-based bandwidth sharing of data center physical links. The DCB supports FCoE, iSCSI, Network-Attached Storage (NAS), Management, and IPC traffic flows. For more information on DCB, see [Using Data Center Bridging \(DCB\)](#).

FCoE Boot from SAN

This section describes the install and boot procedures for the Windows, Linux, ESX, and Solaris operating systems.

 **NOTE:** FCoE Boot from SAN is not supported on ESXi 5.0. ESX Boot from SAN is supported on ESXi 5.1 and above.

The following section details the BIOS setup and configuration of the boot environment prior to the OS install.

Preparing System BIOS for FCoE Build and Boot

Modify System Boot Order

The Broadcom initiator must be the first entry in the system boot order. The second entry must be the OS installation media. It is important that the boot order be set correctly or else the installation will not proceed correctly. Either the desired boot LUN will not be discovered or it will be discovered but marked offline.

Specify BIOS Boot Protocol (if required)

On some platforms, the The boot protocol must be configured through system BIOS configuration. On all other systems the boot protocol is specified through the Broadcom Comprehensive Configuration Management (CCM), and for those systems this step is not required.

Prepare Broadcom Multiple Boot Agent for FCoE Boot

1. During POST, press **CTRL+S** at the Broadcom NetXtreme Ethernet Boot Agent banner to invoke the CCM utility.

```

Press Ctrl-S to Configure Device (MAC Address - A4BADB4FF178)

All of the disks from your previous configuration are gone.  If this is
an unexpected message, then please power off your system and check your cables
to ensure all disks are present.
Press any key to continue, or 'C' to load the configuration utility.

0 Virtual Drive(s) found on the host adapter.

0 Virtual Drive(s) handled by BIOS

Broadcom NetXtreme Ethernet Boot Agent
Copyright (C) 2000-2010 Broadcom Corporation
All rights reserved.
Press Ctrl-S to enter Configuration Menu

```

2. Select the device through which boot is to be configured.

 NOTE: IMPORTANT: When running in NIC Partitioning (NPAR) mode, FCoE boot is supported only when the first function on each port is assigned an FCoE personality. FCoE boot is not supported when the FCoE personality is assigned to any other function.

```

Comprehensive Configuration Management v6.4.21
Copyright (C) 2000-2011 Broadcom Corporation
All rights reserved.

```

Device List

```

<01:00:00> BCM5709C - 00:26:B9:32:94:40 MBA:BIOS Built-in
<01:00:01> BCM5709C - 00:26:B9:32:94:42 MBA:BIOS Built-in
<02:00:00> BCM5709C - 00:26:B9:32:94:44 MBA:BIOS Built-in
<02:00:01> BCM5709C - 00:26:B9:32:94:46 MBA:BIOS Built-in
<07:00:00> BCM57712 - 00:10:18:6F:D5:0C MBA:v6.4.19 CCM:v6.4.21
<07:00:01> BCM57712 - 00:10:18:6F:D5:0E MBA:v6.4.19 CCM:v6.4.21

```

```

Select Device to Configure
[Enter]:Enter; [↑↓]:Next Entry; [ESC]:Quit Menu

```

3. Ensure DCB/DCBX is enabled on the device. FCoE boot is only supported on DCBX capable configurations. As such, DCB/DCBX must be enabled, and the directly attached link peer must also be DCBX capable with parameters that allow for full DCBX synchronization.

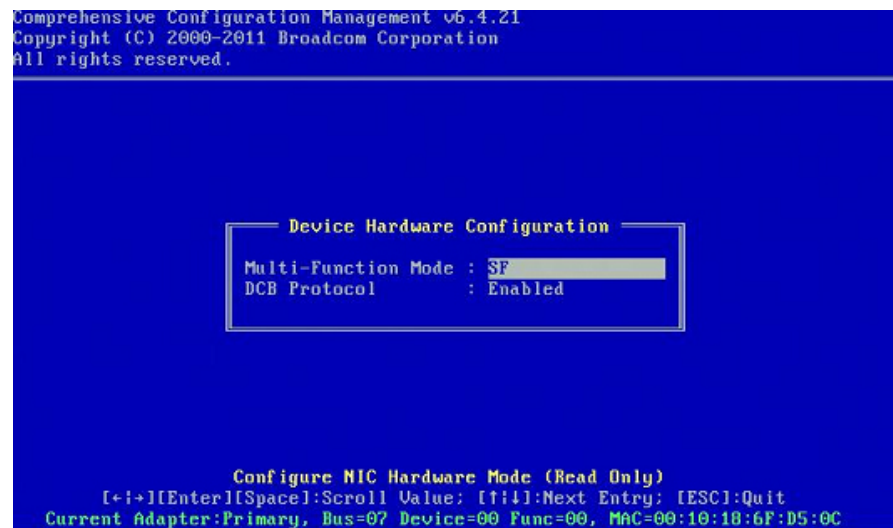

- On some platforms, you may need to set the boot protocol through system BIOS configuration in the integrated devices pane as described above.

For all other devices, set the **Boot Protocol** field to **FCoE** in the MBA Configuration Menu through CCM.

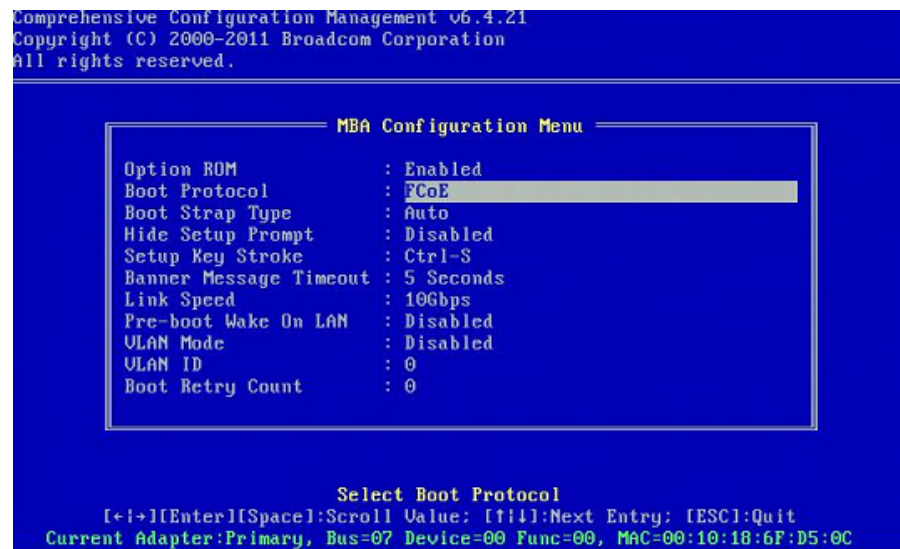

- Configure the desired boot target and LUN. From the Target Information Menu, select the first available path.

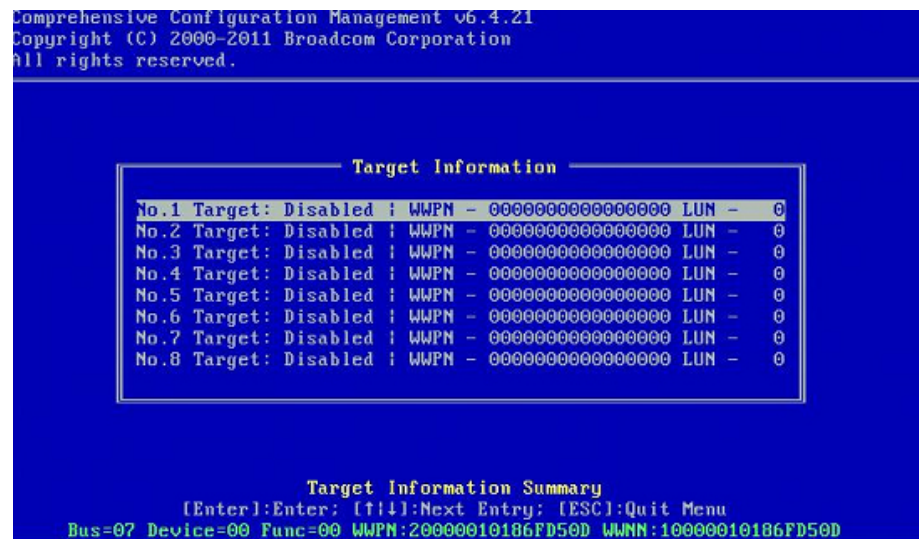

6. Enable the **Connect** field. Enter the target WWPN and Boot LUN information for the target to be used for boot.

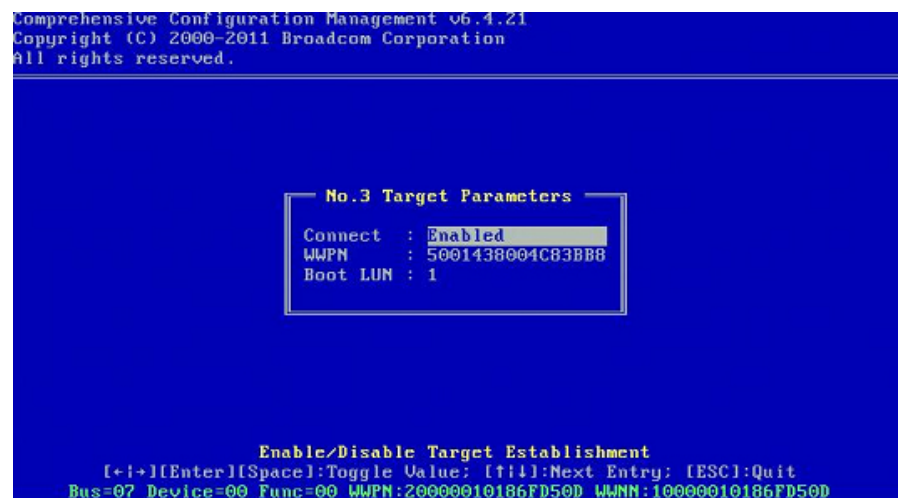

```
Comprehensive Configuration Management 06.4.21
Copyright (C) 2000-2011 Broadcom Corporation
All rights reserved.
```

```

===== Target Information =====
No.1 Target: Enabled | WWPN - 5001438004c83bb8 LUN - 1
No.2 Target: Enabled | WWPN - 5001438004c83bbd LUN - 1
No.3 Target: Disabled | WWPN - 0000000000000000 LUN - 0
No.4 Target: Disabled | WWPN - 0000000000000000 LUN - 0
No.5 Target: Disabled | WWPN - 0000000000000000 LUN - 0
No.6 Target: Disabled | WWPN - 0000000000000000 LUN - 0
No.7 Target: Disabled | WWPN - 0000000000000000 LUN - 0
No.8 Target: Disabled | WWPN - 0000000000000000 LUN - 0

Target Information Summary
[Enter]:Enter; [F4]:Next Entry; [ESC]:Quit Menu
Bus=07 Device=00 Func=00 WWPN:20000010186FD50D WWNN:10000010186FD50D

```

- Press **ESC** until prompted to exit and save changes.
- Proceed to OS installation once storage access has been provisioned in the SAN.

Provisioning Storage Access in the SAN

Storage access consists of zone provisioning and storage selective LUN presentation, each of which is commonly provisioned per initiator WWPN. Two main paths are available for approaching storage access:

- [Pre-Provisioning](#)
- [CTRL+R Method](#)

Pre-Provisioning

With pre-provisioning, note the initiator WWPN and manually modify fabric zoning and storage selective LUN presentation to allow the appropriate access for the initiator.

The initiator WWPN can be seen at the bottom of the screen in the FCoE boot target configuration window.

The initiator WWPN can also be directly inferred from the FIP MAC address associated with the interface(s) planned for boot. Two MAC addresses are printed on stickers attached to the SFP+ cage on your adapter. The FIP MAC ends in an odd digit. The WWPN is 20:00: + <FIP MAC>. For example, if the FIP MAC is 00:10:18:11:22:33, then the WWPN will be 20:00:00:10:18:11:22:33.

 NOTE: The default WWPN is 20:00: + <FIP MAC>. The default WWNN is 10:00: + <FIP MAC>.

 NOTE: In Dell FlexAddress configurations, the SAN/FIP MAC may be overridden by the blade chassis management system.

CTRL+R Method

The **CTRL+R** method allows you to use the boot initiator to bring up the link and login into all available fabrics and targets. Using this method, you can ensure that the initiator is logged into the fabric/target before making provisioning changes, and as such, can provision without manually typing in WWPNs.

- Configure at least one boot target through CCM as described above.
- Allow the system to attempt to boot through the selected initiator.
- Once the initiator boot starts, it will commence with DCBX sync, FIP Discovery, Fabric Login, Target Login, and LUN readiness checks. As each of these phases completes, if the initiator is unable to proceed to the next phase, MBA will present the option to press **CTRL+R**.
- Once **CTRL+R** has been activated, the boot initiator will maintain a link in whatever phase has most recently succeeded and allow you time to make the necessary provisioning corrections to proceed to the next phase.

5. If the initiator logs into the fabric, but is unable to log into the target, a **CTRL+R** will pause the boot process and allow you to configure fabric zoning.
6. Once zoning is complete, the initiator will automatically log into all visible targets. If the initiator is unable to discover the designated LUN on the designated target as provisioned in step 1, **CTRL+R** will pause the boot process and allow you to configure selective LUN presentation.
7. The boot initiator will periodically poll the LUN for readiness, and once the user has provisioned access to the LUN, the boot process will automatically proceed.

 NOTE: This does not preclude the need to put the boot initiator into one-time disabled mode as described in [One-Time Disabled](#).

One-Time Disabled

Broadcom's FCoE ROM is implemented as Boot Entry Vector (BEV). In this implementation, the Option ROM only connects to the target once it has been selected by BIOS as the chosen boot device. This is different from other implementations that will connect to the boot device even if another device has been selected by the system BIOS. For OS installation over the FCoE path, it is necessary to instruct the Option ROM to bypass FCoE and skip to CD/DVD installation media. As instructed earlier, the boot order must be configured with Broadcom boot first and installation media second. Furthermore, during OS installation, it is required to bypass the FCoE boot and pass through to the installation media for boot. It is required to do this by one-time disabling the FCoE boot ROM from booting, and not by simply allowing the FCoE ROM to attempt to boot and allowing the BIOS to fail through and boot the installation media. Finally, it is required that the FCoE ROM successfully discover and test the readiness of the desired boot LUN in order for installation to proceed successfully. Failure to allow the boot ROM to discover the LUN and do a coordinated bypass will result in a failure to properly install the O/S to the LUN. In order to affect this coordinated bypass, there are two choices:

- Once the FCoE boot ROM discovers a ready target LUN, it will prompt you to press **CTRL+D** within 4 seconds to **Stop booting from the target**. Press **CTRL+D**, and proceed to boot from the installation media.
- From CCM, set the **Option ROM** setting under MBA settings to **One Time Disabled**. With this setting, the FCoE ROM will load once and automatically bypass once the ready LUN is discovered. On the subsequent reboot after installation, the option ROM will automatically revert to **Enabled**.

Wait through all option ROM banners. Once FCoE Boot is invoked, it will connect to the target, and provide a 4 second window to press **CTRL+D** to invoke the bypass. Press **CTRL+D** to proceed to installation.

```
Copyright (C) 2000-2011 Broadcom Corporation
FCoE Boot v6.4.20

Starting DCBX process with interface (00:10:18:6F:D5:0F) ... Succeeded
Discovering FC Fabric with interface (00:10:18:6F:D5:0F) ... Succeeded

World Wide Node Name : 10:00:00:10:18:6F:D5:0F
World Wide Port Name : 20:00:00:10:18:6F:D5:0F
Fabric Name          : 10:00:00:05:1E:B0:38:80
FCF MAC Address      : 00:05:1E:B0:38:95
FP MAC Address       : 0E:FC:00:01:1D:01
VLAN ID              : 1003

Fabric Login via interface (00:10:18:6F:D5:0F) ... Succeeded
Login to target [5001438004C83BBD:600000:LUN=0011] ... Succeeded

FC Target Drive: HP          HSU300          (Rev: 0005)

Press <Ctrl-D> within 4s to stop booting from the target ... _
```

Windows Server 2008 R2 and Windows Server 2008 SP2 FCoE Boot Installation

Ensure that no USB flash drive is attached before starting the OS installer. The EVBD and OFC/BXFOE drivers need to be loaded during installation. Go through the normal procedures for OS installation. When no disk devices are found, Windows will prompt you to load additional drivers. At this point, connect a USB flash drive containing the full contents of the provided EVBD and OFC boot driver folders. After all appropriate drivers are loaded, the setup show the target disk(s). Disconnect the USB flash drive before selecting the disk for installation.

1. Load the EVBD driver first.

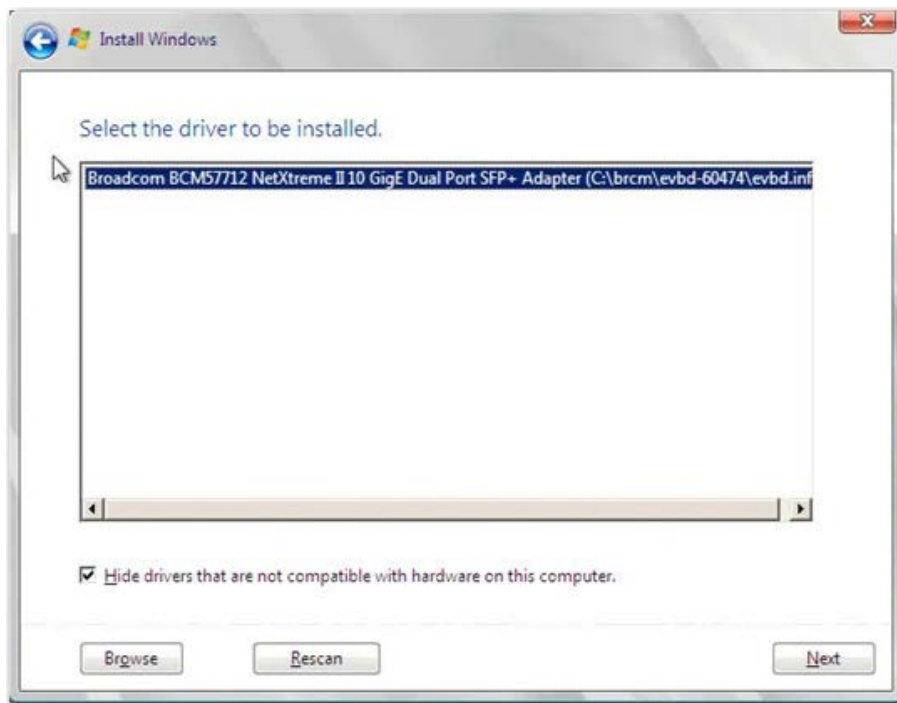

2. Then load the bxfcoe (OFC) driver.

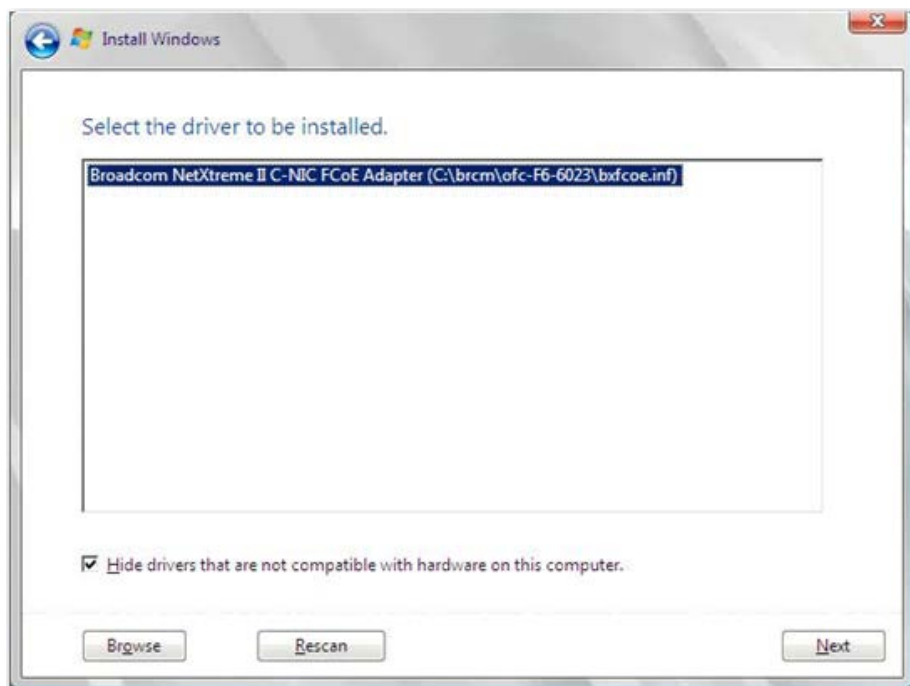

3. Select the boot LUN to be installed:

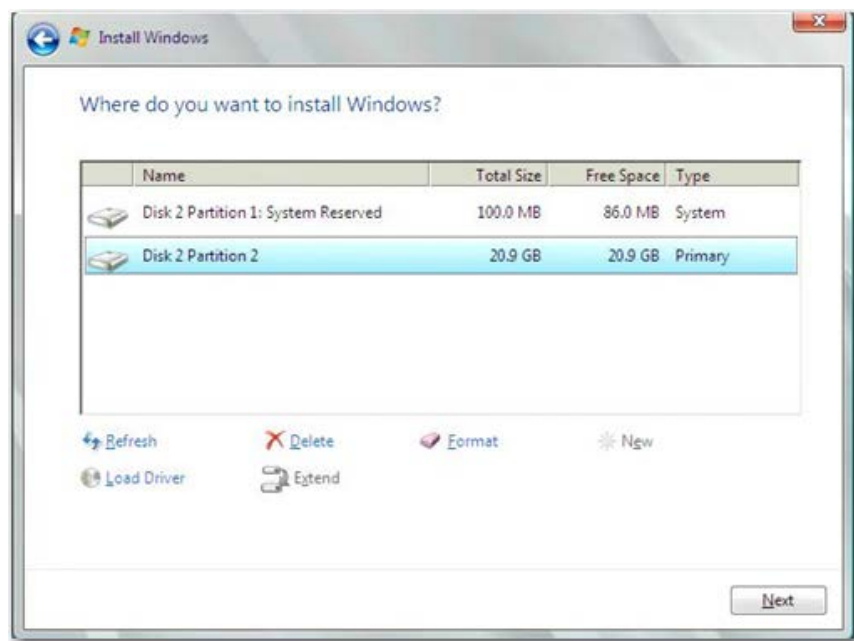

4. Continue with the rest of the installation. After installation is complete and booted to SAN, execute the provided Windows driver installer and reboot. Installation is now complete.

NOTE: The boot initiator must be configured to point at the desired installation LUN, and the boot initiator must have successfully logged and determined the readiness of the LUN prior to starting installation. If these requirements are not met, the devices will still show up in the drive list above, but upon proceeding with installation Read/Write errors will occur.

Windows Server 2012 FCoE Boot Installation

For Windows Server 2012 Boot from SAN installation, Broadcom requires the use of a "slipstream" DVD or iso image with the latest Broadcom drivers injected. See [Injecting \(Slipstreaming\) Broadcom Drivers into Windows Image Files](#) in the iSCSI chapter. Also, refer to the Microsoft Knowledge Base topic KB974072 at support.microsoft.com, which is helpful for Windows Server 2012 FCoE Boot from SAN also. Microsoft's procedure injects only the eVBD and NDIS drivers. Broadcom strongly recommends that all drivers, especially those bolded, are injected:

- **eVBD**
- VBD
- BXND
- OIS
- **FCoE**
- NetXtreme I NDIS

Once you have a properly slipstreamed iso, you can use that iso for normal Windows Server 2012 installation, without needing USB-provided drivers.

NOTE: Refer to the *silent.txt* file for the specific driver installer application for instructions on how to extract the individual Windows NetXtreme II drivers.

Linux FCoE Boot Installation

Configure the adapter boot parameters and Target Information (press **CTRL+S** and enter the CCM utility) as detailed in [Preparing System BIOS for FCoE Build and Boot](#). Then, use the guidelines in the following sections for FCoE boot installation with the appropriate Linux version.

- [SLES11 SP2 Installation](#)
- [RHEL6 Installation](#)

SLES11 SP2 Installation

1. Boot from the SLES11 SP2 installation medium and on the installation splash screen press **F6** for driver update disk. Select **Yes**. In boot options, type `withfcoe=1`. Select **Installation** to proceed.



2. Follow the on screen instructions to choose the Driver Update medium and load drivers.

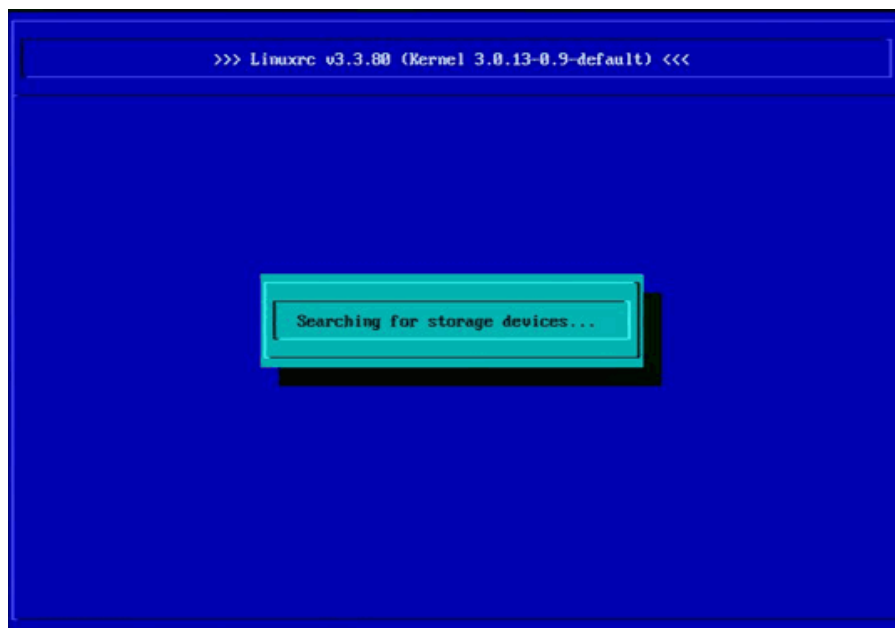
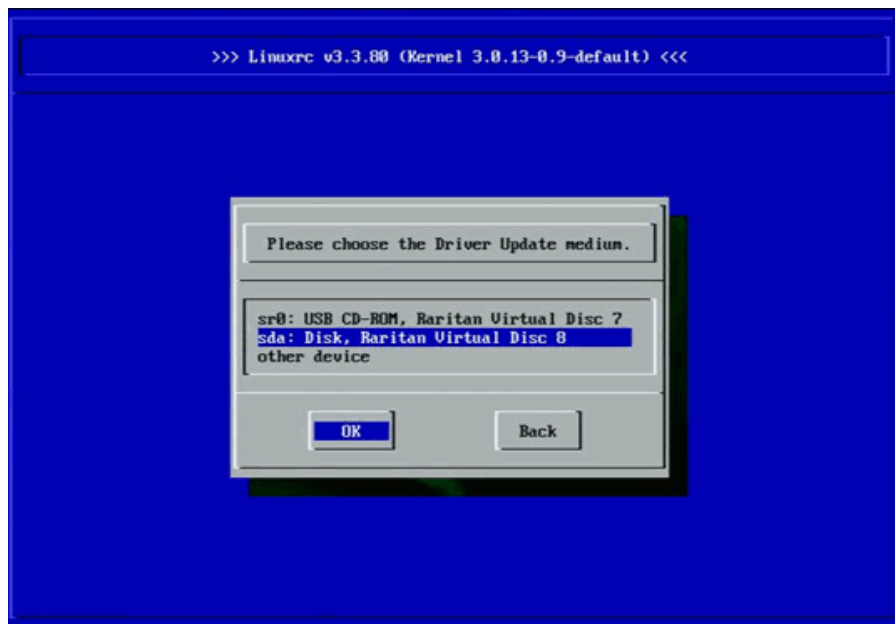

3. Once the driver update is complete, select **Next** to continue with OS installation.
4. When requested, click **Configure FCoE Interfaces**.

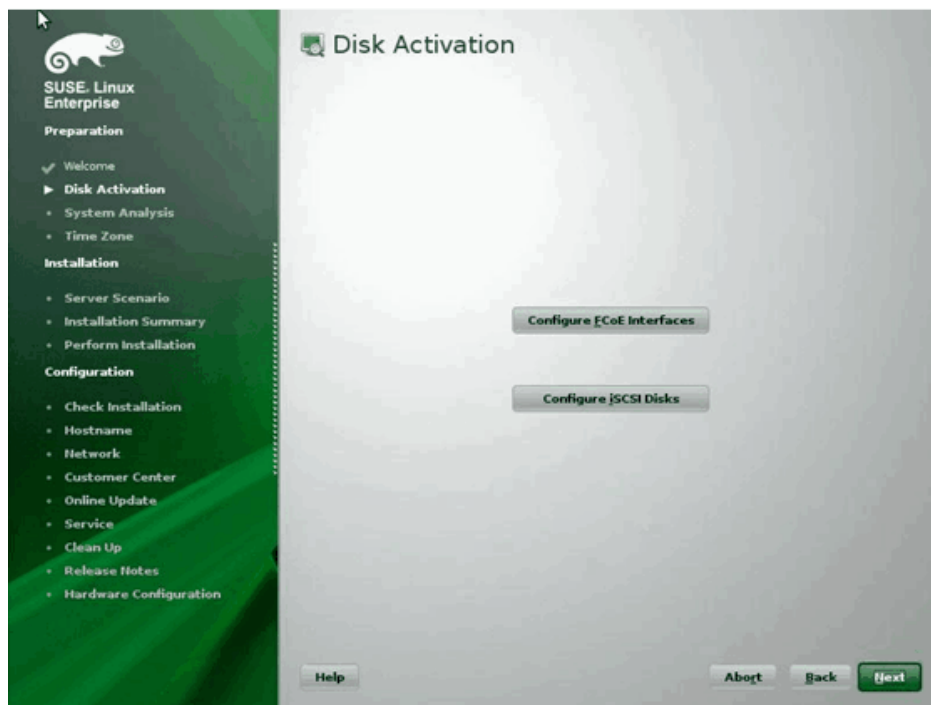

5. Ensure **FCoE Enable** is set to **yes** on the 10GbE Broadcom initiator ports you wish to use as the SAN boot path(s).

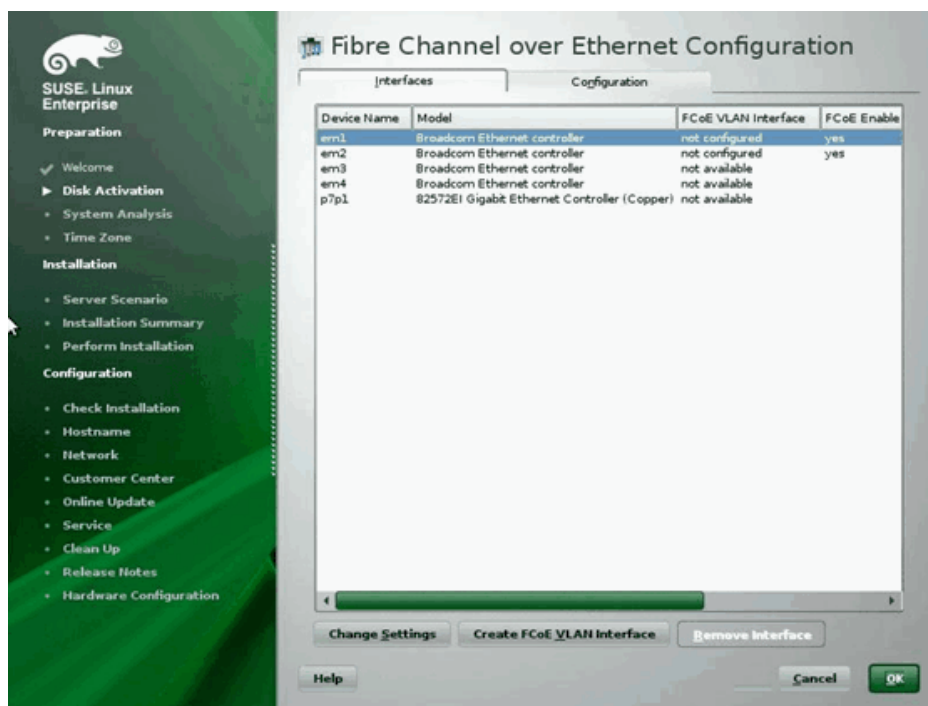

6. For each interface to be enabled for FCoE boot, click **Change Settings** and ensure **FCoE Enable** and **AUTO_VLAN** are set to **yes** and **DCB required** is set to **no**.

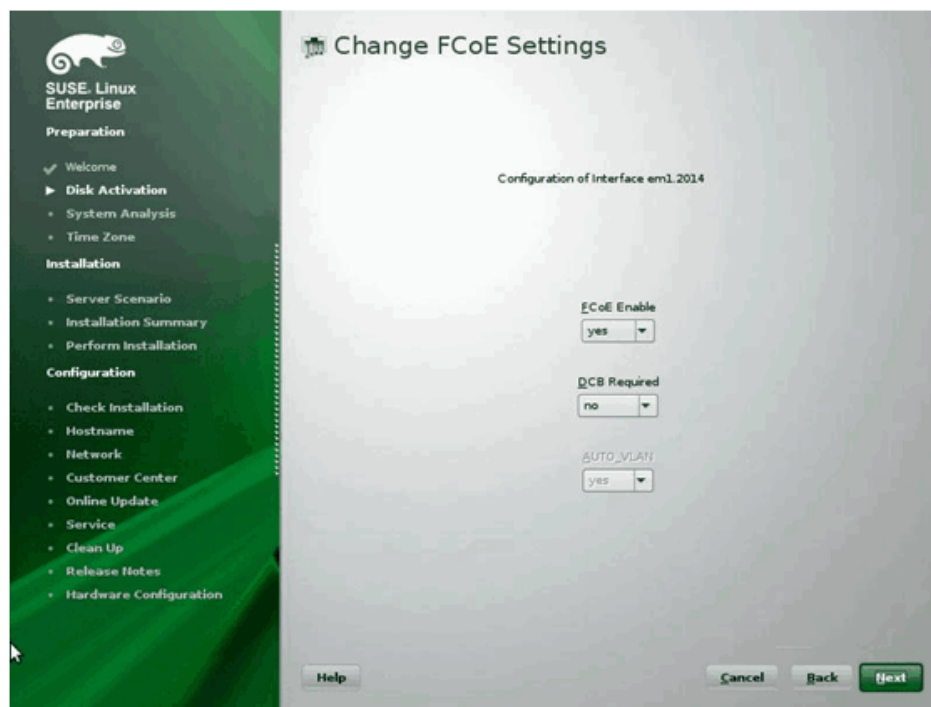

7. For each interface to be enabled for FCoE boot, click on **Create FCoE VLAN Interface**. The VLAN interface creation dialog will launch. Click **Yes** to confirm. This will trigger automatic FIP VLAN discovery. If successful, the VLAN will be displayed under **FCoE VLAN Interface**. If no VLAN is visible, check your connectivity and switch configuration.
8. Once complete with configuration of all interface, click **OK** to proceed.

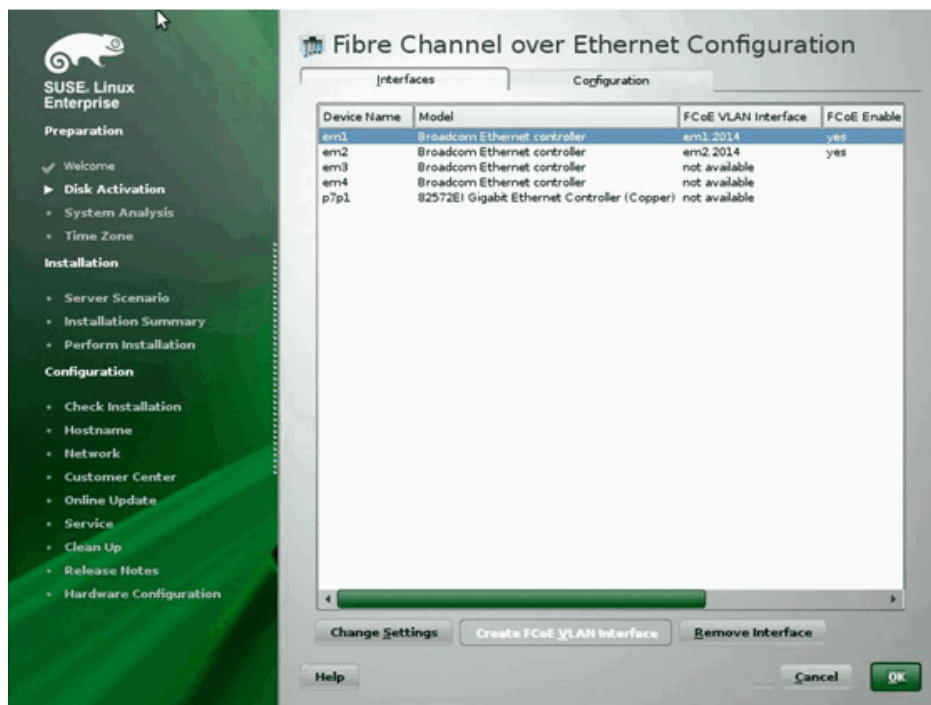

9. Click **Next** to continue installation. YaST2 will prompt to activate multipath. Answer as appropriate.



10. Continue installation as usual.
11. Under the **Expert** tab on the Installation Settings screen, select **Booting**.

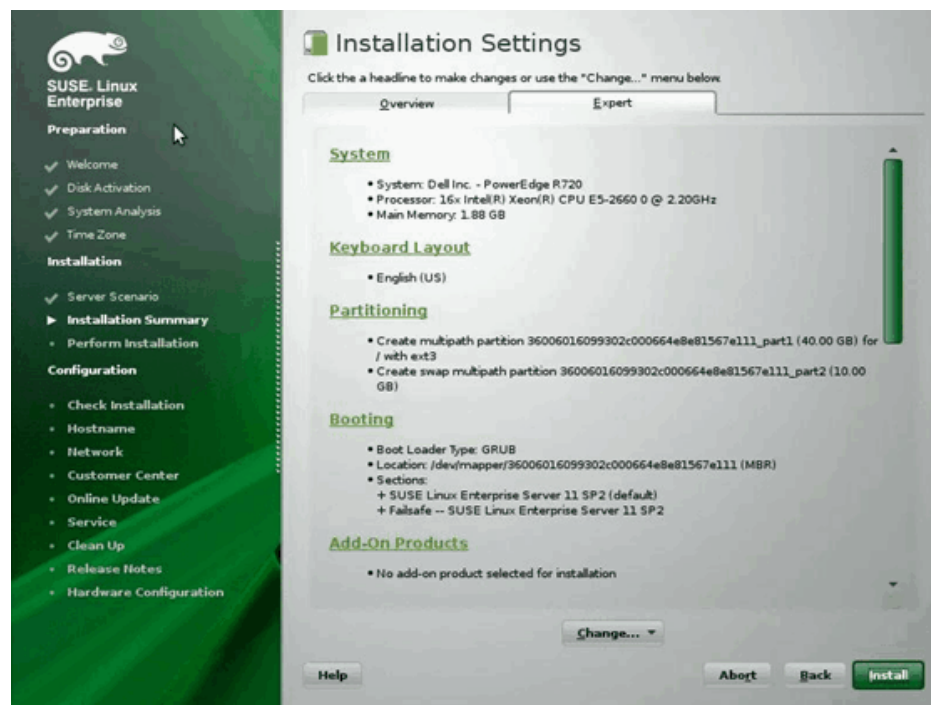

12. Select the **Boot Loader Installation** tab and then select **Boot Loader Installation Details**, make sure you have one boot loader entry here. Delete all redundant entries.

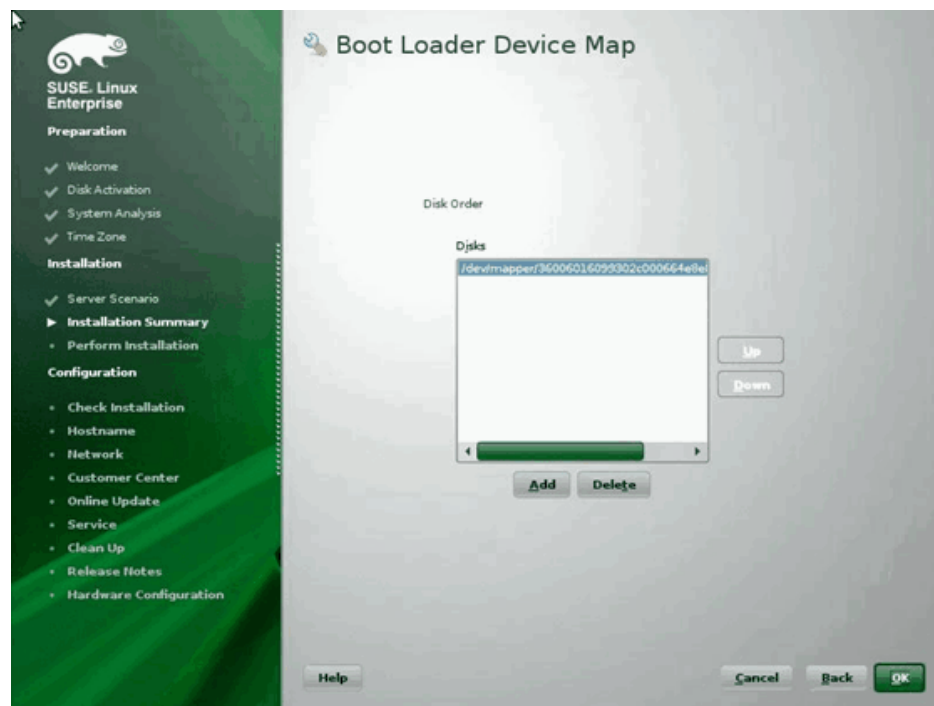

13. Click **OK** to proceed and complete installation.

RHEL6 Installation

1. Boot from the installation medium.
2. For RHEL6.3, an updated Anaconda image is required for FCoE BFS. That updated image is provided by Red Hat at the following URL <http://rvykydal.fedorapeople.org/updates.823086-fcoe.img>.
3. For RHEL6.3, on the installation splash screen, press **Tab** and add the options **dd updates=<URL_TO_ANACONDA_UPDATE_IMAGE>** to the boot command line. Please refer to the RedHat Installation Guide Section 28.1.3 (http://docs.redhat.com/docs/en-US/Red_Hat_Enterprise_Linux/6/html/Installation_Guide/ap-admin-options.html#sn-boot-options-update) for details about installing the Anaconda update image. Press **Enter** to proceed.
4. For RHEL6.4 and above, no updated Anaconda is required. On the installation splash screen press **Tab** and add the option **dd** to the boot command line, as shown in the following screen. Press **Enter** to proceed.



5. When prompted **Do you have a driver disk**, enter **Yes**. Note: RHEL does not allow driver update media to be loaded via the network when installing driver updates for network devices. Use local media.

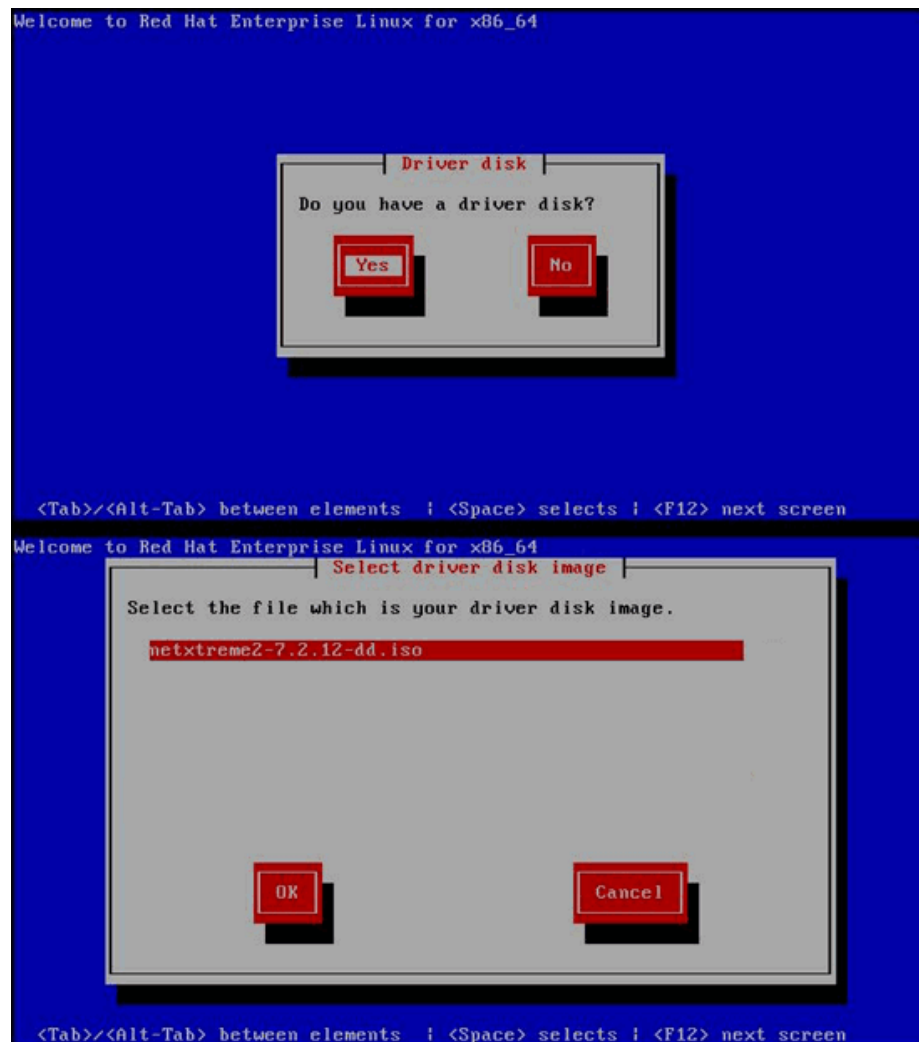

6. Once drivers are loaded, proceed with installation.
7. Select **Specialized Storage Devices** when prompted.



8. Click **Add Advanced Target**.



9. Select **Add FCoE SAN**, and select **Add drive**.

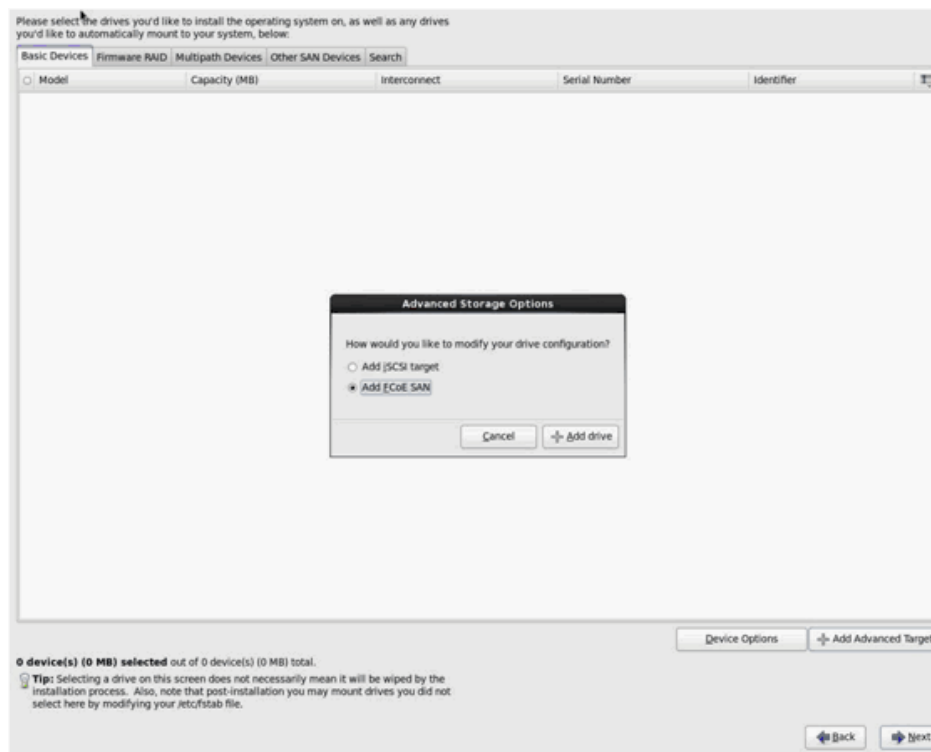

10. For each interface intended for FCoE boot, select the interface, deselect **Use DCB**, select **Use auto vlan**, and then click **Add FCoE Disk(s)**.

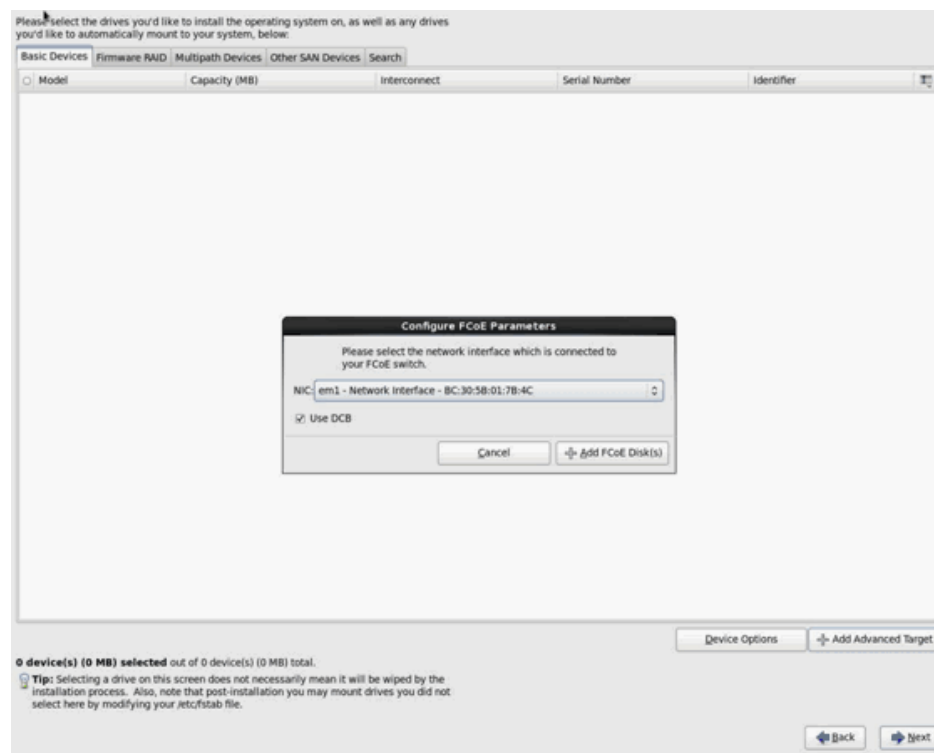

11. Repeat steps 8 through 10 for all initiator ports.
12. Confirm all FCoE visible disks are visible under **Multipath Devices** and/or **Other SAN Devices**.

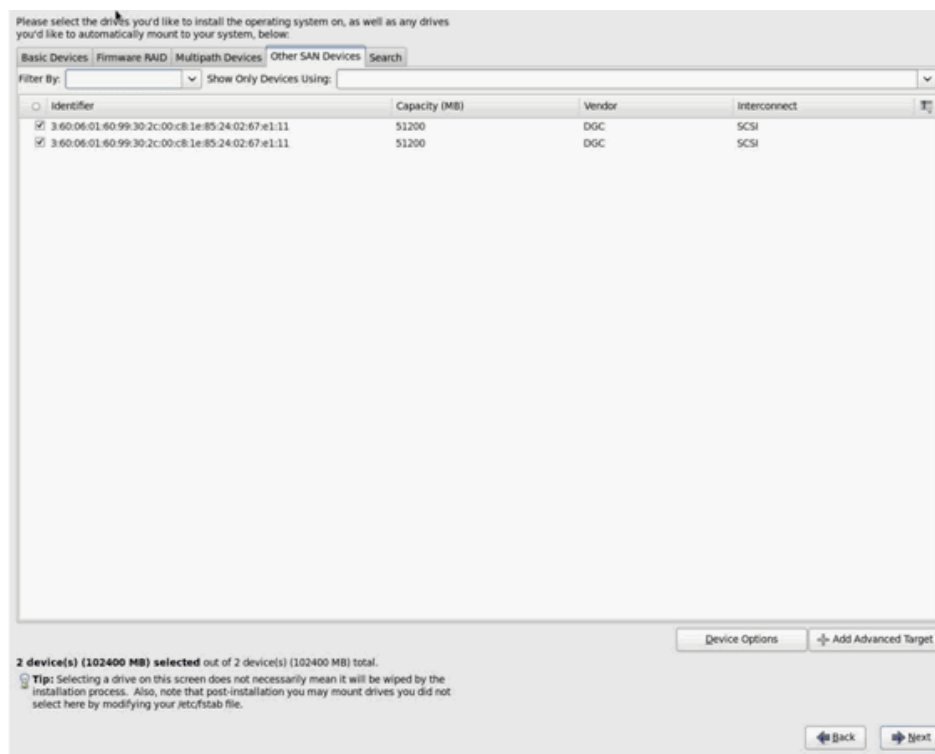

13. Click **Next** to proceed.
14. Click **Next** and complete installation as usual.

Upon completion of installation, the system will reboot.

15. Once booted, ensure all boot path devices are set to start on boot. Set `onboot=yes` under each network interface config file in `/etc/sysconfig/network-scripts`.
16. **On RHEL 6.4 only**, edit `/boot/grub/menu.lst`.
 - a. Delete all "`fcoe=<INTERFACE>:nodcb`" parameters from the "`kernel /vmlinuz ...`" line. There should be as many `fcoe=` parameters as there were FCoE interfaces configured during installation.
 - b. Insert "`fcoe=edd:nodcb`" to the "`kernel /vmlinuz ...`" line.

Linux: Adding Additional Boot Paths

Both RHEL and SLES require updates to the network configuration when adding new boot through an FCoE initiator that was not configured during installation. The following sections describe this procedure for each supported operating system.

RHEL6.2 and Above

On RHEL6.2 and above, if the system is configured to boot through an initiator port that has not previously been configured in the OS, the system automatically boots successfully, but will encounter problems during shutdown. All new boot path initiator ports must be configured in the OS before updating pre-boot FCoE boot parameters.

1. Identify the network interface names for the newly added interfaces through `ifconfig -a`.
2. Edit `/boot/grub/menu.lst`.
 - a. Add `ifname=<INTERFACE>:<MAC_ADDRESS>` to the line `kernel /vmlinuz ...` for each new interface. The MAC address must be all lower case and separated by a colon. (e.g., `ifname=em1:00:00:00:00:00:00`)
3. Create a `/etc/fcoe/cfg-<INTERFACE>` file for each new FCoE initiator by duplicating the `/etc/fcoe/cfg-<INTERFACE>` file that was already configured during initial installation.

4. Execute `nm-connection-editor`.
 - a. Open **Network Connection** and choose each new interface.
 - b. Configure each interface as desired, including DHCP settings.
 - c. Click **Apply** to save.
5. For each new interface, edit `/etc/sysconfig/network-scripts/ifcfg-<INTERFACE>` to add the line `NM_CONTROLLED="no"`. Modifying these files automatically causes a restart to the network service. This may cause the system to appear to hang briefly. It is best to ensure that redundant multipath paths are available before performing this operation.

SLES 11 SP2 and Above

On SLES11 SP2, if the system boots through an initiator that has not been configured as an FCoE interface during installation, the system will fail to boot. To add new boot paths, the system must boot up through the configured FCoE interface.

1. Configure a new FCoE interface that will be added as a new path so it can discover the boot LUN.
 - a. Create a `/etc/fcoe/cfg-<INTERFACE>` file for each new FCoE initiator by duplicating the `/etc/fcoe/cfg-<INTERFACE>` file that was already configured during initial installation.
 - b. Bring up the new interfaces:

```
# ifconfig <INTERFACE> up
```
 - c. Restart FCoE service:



```
# rcfcoe restart
```
2. Run `multipath -l` to make sure the system has a correct number of multipaths to the boot LUN, including new paths.
3. Create a `/etc/sysconfig/network/ifcfg-<INTERFACE>` file for each new interface by duplicating the `/etc/sysconfig/network/ifcfg-<INTERFACE>` file that was already configured during initial installation.
4. Create a new ramdisk to update changes:

```
# mkinitrd
```

VMware ESXi 5.1 FCoE Boot Installation

FCoE Boot from SAN requires that the latest Broadcom NetXtreme II async drivers be included into the ESXi 5.1 install image. Refer to *Image_builder_doc.pdf* from VMware on how to slipstream drivers.

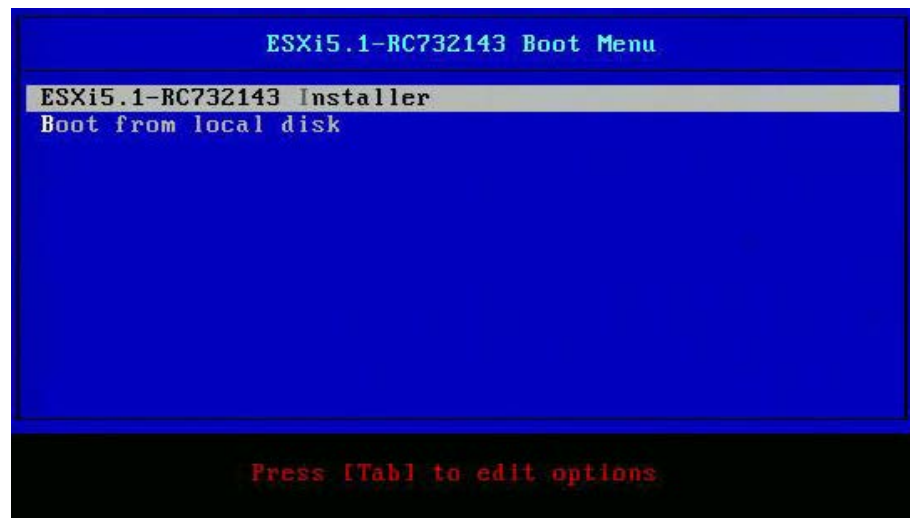
1. Boot from the updated ESXi 5.1 installation image and select **ESXi 5.1 installer** when prompted.



2. Press **Enter** to continue.

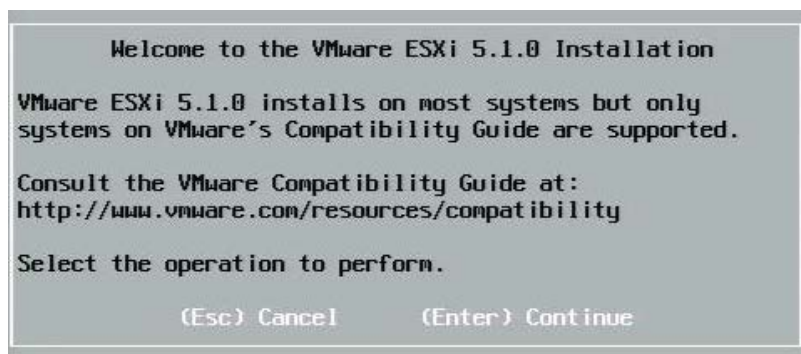

3. Press **F11** to accept the agreement and continue.

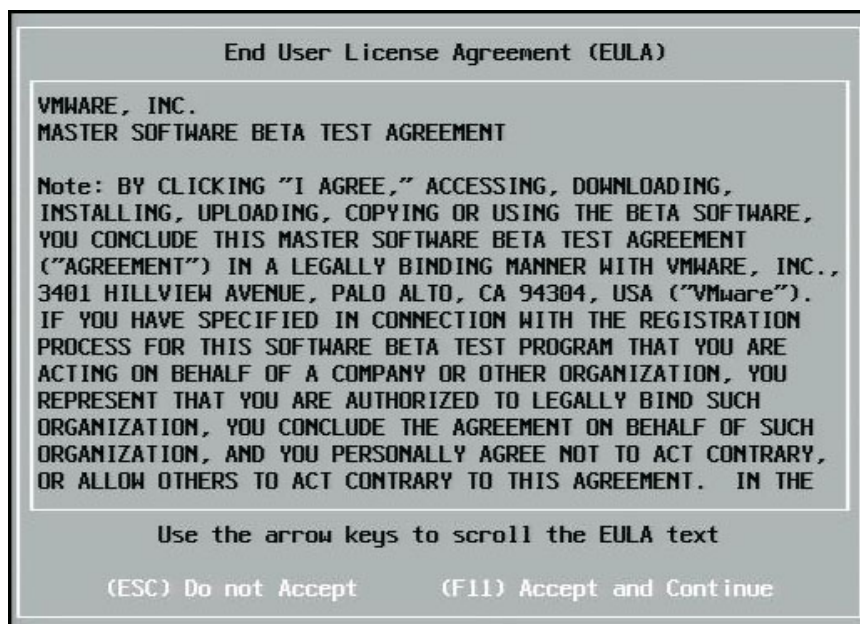

4. Select the boot LUN for installation and press **Enter** to continue.



5. Select the desired installation method.

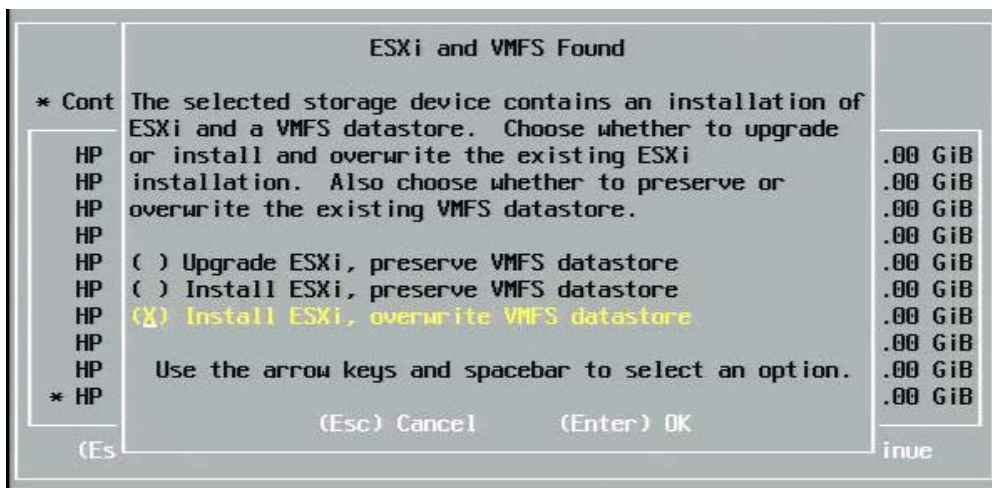

6. Select the keyboard layout.



7. Enter a password.

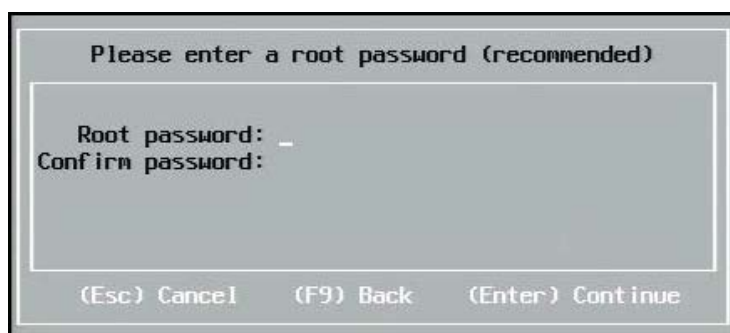

8. Press **F11** to confirm the install.



9. Press **Enter** to reboot after installation.

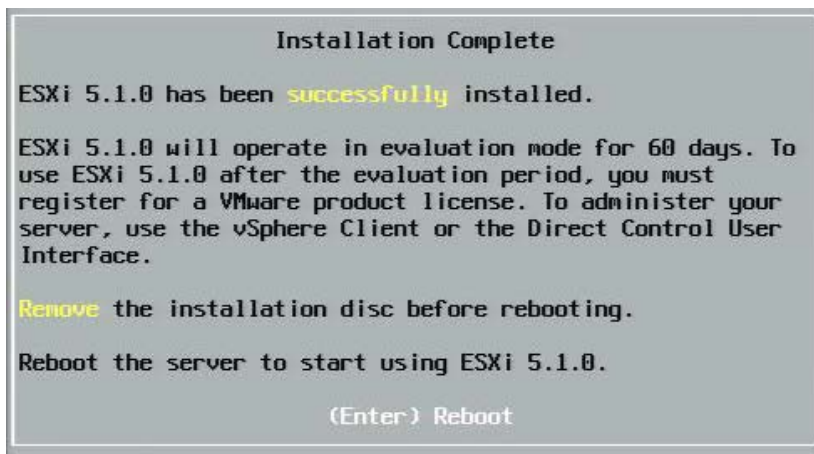

10. On 57800 and 57810 boards, the management network is not vmnic0. After booting, open the GUI console and display the **configure management network > network adapters** screen to select the NIC to be used as the management network device.

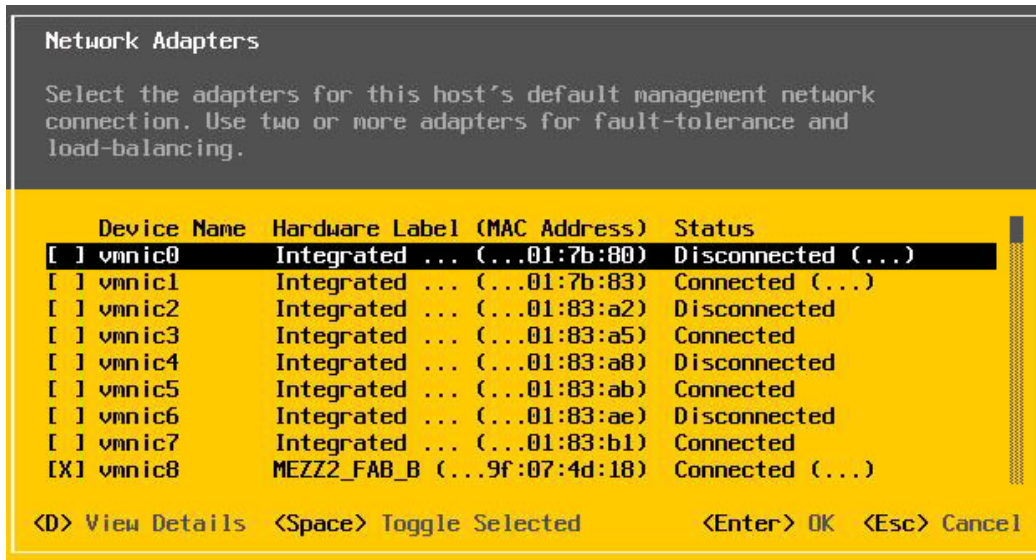

11. For BCM57800 and BCM57810 boards, the FCoE boot devices need to have a separate vSwitch other than vSwitch0. This allows DHCP to assign the IP address to the management network rather than to the FCoE boot device. To create a vSwitch for the FCoE boot devices, add the boot device vmnics in vSphere Client under Networking.

Hardware

Processors
Memory
Storage
▶ Networking
Storage Adapters
Network Adapters
Advanced Settings
Power Management

Software

Licensed Features
Time Configuration
DNS and Routing
Authentication Services
Power Management
Virtual Machine Startup/Shutdown
Virtual Machine Swapfile Location
Security Profile
Host Cache Configuration
System Resource Allocation
Agent VM Settings
Advanced Settings

View: vSphere Standard Switch vSphere Distributed Switch

Networking

Refresh Add Networking... Properties...

Standard Switch: vSwitch0

Remove... Properties...

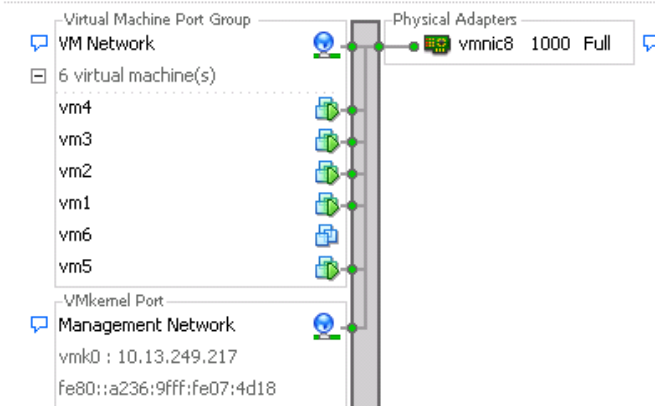

Standard Switch: vSwitch1

Remove... Properties...



 NOTE: ESXi 5.1 has a limitation in that a VLAN ID change for a boot device is not possible. It works only for non-boot devices.

Configuring FCoE Boot from SAN on VMware

Note that each host must have access only to its own boot LUN — not to the boot LUNs of other hosts. Use storage system software to ensure that the host accesses only the designated LUNs.

Booting from SAN After Installation

Now that boot configuration and OS installation are complete, you can reboot and test the installation. On this and all future reboots, no other user interactivity is required. Ignore the **CTRL+D** prompt and allow the system to boot through to the FCoE SAN LUN.

At this time, if additional redundant failover paths are desired, you can configure those paths through CCM, and the MBA will automatically failover to secondary paths if the first path is not available. Further, the redundant boot paths will yield redundant paths visible through host MPIO software allowing for a fault tolerant configuration.

```

Copyright (C) 2000-2011 Broadcom Corporation
FCoE Boot v6.4.20

Starting DCBX process with interface (00:10:18:6F:D5:0F) ... Succeeded
Discovering FC Fabric with interface (00:10:18:6F:D5:0F) ... Succeeded

World Wide Node Name : 10:00:00:10:18:6F:D5:0F
World Wide Port Name : 20:00:00:10:18:6F:D5:0F
Fabric Name          : 10:00:00:05:1E:B0:38:80
FCF MAC Address      : 00:05:1E:B0:38:95
FP MAC Address       : 0E:FC:00:01:1D:01
VLAN ID              : 1003

Fabric Login via interface (00:10:18:6F:D5:0F) ... Succeeded
Login to target [5001438004C83BBD:600000:LUN=001] ... Succeeded

FC Target Drive: HP          HSU300          (Rev: 0005)

Press <Ctrl-D> within 4s to stop booting from the target ... _

```

Driver Upgrade on Linux Boot From SAN Systems

1. Remove the existing installed NetXtreme II package. Log in as root. Query for the existing NetXtreme II package and remove it using the following commands:

```
# rpm -e <NetXtreme II package name>
```

For example:

```
rpm -e netxtreme2
```

or:

```
rpm -e netxtreme2-x.y.z-1.x86_64
```

2. Install the binary RPM containing the new driver version. Refer to the linux-nx2 package README for instructions on how to prepare a binary driver RPM.
3. Use the following command to update the ramdisk:
 - o On RHEL 6.x systems, execute: `dracut -force`
 - o On SLES11spX systems, execute: `mkinitrd`
4. If you are using different name for the initrd under /boot, be sure to overwrite it with the default, as dracut/mkinitrd updates the ramdisk with the default original name.

Also, verify that your appropriate entry for the boot from SAN setup uses the correct or updated intrd name in /boot/grub/menu.lst.
5. To complete your driver upgrade, reboot the system and select the modified grub boot entry that contains the updated initrd.

Errors During Windows FCoE Boot From SAN Installation

If any USB flash drive is connected while Windows setup is loading files for installation, an error message will appear when you provide the drivers and then select the SAN disk for the installation. The most common error message that Windows OS installer reports is "We couldn't create a new partition or locate an existing one. For more information, see the Setup log files."

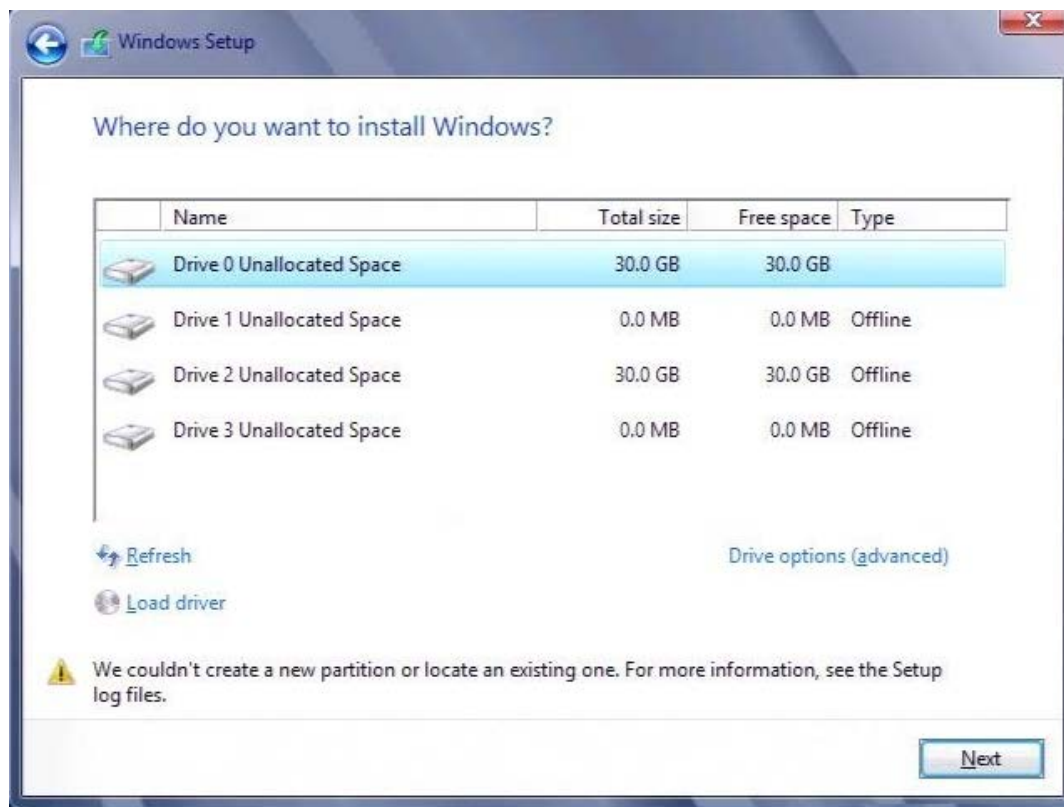

In other cases, the error message may indicate a need to ensure that the disk's controller is enabled in the computer's BIOS menu.

To avoid any of the above error messages, it is necessary to ensure that there is no USB flash drive attached until the setup asks for the drivers. Once you load the drivers and see your SAN disk(s), detach or disconnect the USB flash drive immediately before selecting the disk for further installation.

Configuring FCoE

By default, DCB is enabled on Broadcom NetXtreme II FCoE-, DCB-compatible C-NICs. Broadcom NetXtreme II FCoE requires a DCB-enabled interface. For Windows operating systems, use either Broadcom Advanced Control Suite (BACS) or Broadcom's Comprehensive Configuration Management (CCM) utility to configure the DCB parameters. See [Using Broadcom Advanced Control Suite](#) for more information on BACS.

Please read all [Restrictions and Disclaimers](#).

[Back to Contents Page](#)

[Back to Contents Page](#)

Data Center Bridging (DCB): Broadcom NetXtreme II® Network Adapter User Guide

- Overview
- DCB Capabilities
- Configuring DCB
- DCB Conditions
- Data Center Bridging in Windows Server 2012

Overview

Data Center Bridging (DCB) is a collection of IEEE specified standard extensions to Ethernet to provide lossless data delivery, low latency, and standards-based bandwidth sharing of data center physical links. DCB supports storage, management, computing, and communications fabrics onto a single physical fabric that is simpler to deploy, upgrade, and maintain than in standard Ethernet networks. DCB has a standards-based bandwidth sharing at its core, allowing multiple fabrics to coexist on the same physical fabric. The various capabilities of DCB allow for LAN traffic (large number of flows and not latency-sensitive), SAN traffic (large packet sizes and requires lossless performance), and IPC (latency-sensitive messages) to bandwidth share the same physical converged connection and achieve the desired individual traffic performance.

DCB includes the following capabilities:

- Enhanced Transmission Selection (ETS)
- Priority-based Flow Control (PFC)
- Data Center Bridging Capability eXchange Protocol (DCBX)

DCB Capabilities

Enhanced Transmission Selection (ETS)

Enhanced Transmission Selection (ETS) provides a common management framework for assignment of bandwidth to traffic classes. Each traffic class or priority can be grouped in a Priority Group (PG), and it can be considered as a virtual link or virtual interface queue. The transmission scheduler in the peer is responsible for maintaining the allocated bandwidth for each PG. For example, a user can configure FCoE traffic to be in PG 0 and iSCSI traffic in PG 1. The user can then allocate each group a certain bandwidth. For example, 60% to FCoE and 40% to iSCSI. The transmission scheduler in the peer will ensure that in the event of congestion, the FCoE traffic will be able to use at least 60% of the link bandwidth and iSCSI to use 40%. See additional references at <http://www.ieee802.org/1/pages/802.1az.html>.

Priority Flow Control (PFC)

Priority Flow Control (PFC) provides a link-level flow control mechanism that can be controlled independently for each traffic type. The goal of this mechanism is to ensure zero loss due to congestion in DCB networks. Traditional IEEE 802.3 Ethernet does not guarantee that a packet transmitted on the network will reach its intended destination. Upper-level protocols are responsible to maintain the reliability by way of acknowledgement and retransmission. In a network with multiple traffic classes, it becomes very difficult to maintain the reliability of traffic in the absence of feedback. This is traditionally tackled with the help of link-level Flow Control.

When PFC is used in a network with multiple traffic types, each traffic type can be encoded with a different priority value and a pause frame can refer to this priority value while instructing the transmitter to stop and restart the traffic. The value range for the priority field is from 0 to 7, allowing eight distinct types of traffic that can be individually stopped and started. See additional references at <http://www.ieee802.org/1/pages/802.1bb.html>.

Data Center Bridging eXchange (DCBX)

Data Center Bridging eXchange (DCBX) is a discovery and capability exchange protocol that is used for conveying capabilities and configuration of ETS and PFC between link partners to ensure consistent configuration across the network fabric. In order for two devices to exchange information, one device must be willing to adopt network configuration from the other device. For example, if a C-NIC is configured to willingly adopt ETS and PFC configuration information from a connected switch, and the switch acknowledges the C-NIC's willingness, then the switch will send the C-NIC the recommended ETS and PFC parameter settings. The DCBX protocol uses the Link Level Discovery Protocol (LLDP) to exchange PFC and ETS configurations between link partners.

Configuring DCB

By default, DCB is enabled on Broadcom NetXtreme II DCB-compatible C-NICs. DCB configuration is rarely required, as the default configuration should satisfy most scenarios. DCB parameters can be configured through BACS. See [Using Broadcom Advanced Control Suite](#) for more information on BACS.

 **NOTE:** FCoE operation depends on successful VLAN discovery. All switches that support FCoE support VLAN discovery, but some switches may require specific configuration. Refer to the switch configuration guides for information on how to configure a port for successful VLAN discovery.

DCB Conditions

The following is a list of conditions that allow DCB technology to function on the network.

- If DCB is enabled on the interface, DCBX is automatically enabled and carried out automatically once a link is established.
- If DCBX fails to synchronize with a compatible peer, the adapter will automatically fall back to default NIC behavior (no priority tagging, no PFC, no ETS).
- By default, the port will advertise itself as willing, and as such, will accept all DCB settings as advertised by the switch.
- If PFC is operational, PFC settings supersede link level flow control settings. If PFC is not operational, link level flow control settings prevail
- In NIC Partitioned enabled configurations, ETS (if operational) overrides the Bandwidth Weights assigned to each function. Transmission selection weights are per protocol per ETS settings instead. Maximum bandwidths per function are still honored in the presence of ETS.
- In the absence of an iSCSI or FCoE application TLV advertised through the DCBX peer, the adapter will use the settings taken from the local Admin MIB.

Data Center Bridging in Windows Server 2012

Windows Server 2012 introduces a new way of managing Quality Of Service (QoS) at the OS level. There are two main aspects of Windows QoS:

- A vendor-independent method for managing DCB settings on NICs, both individually and across an entire domain. The management interface is provided by Windows PowerShell Cmdlets.
- The ability to tag specific types of L2 networking traffic, such as SMB traffic, so that hardware bandwidth can be managed using ETS.

All Broadcom Converged Network Adapters that support DCB are capable of interoperating with Windows QoS.

To enable the QoS Windows feature, ensure that the Broadcom device is DCB-capable. Using either CCM or BACS4:

1. Enable Data Center Bridging.
2. Select the NDIS driver, display **Advanced** properties, and enable the **Quality of Service** property.

When QoS is enabled, administrative control over DCB-related settings is relinquished to the operating system (that is, BACS4 can no longer be used for administrative control of the DCB). You can use PowerShell to configure and manage the QoS feature. Using PowerShell Cmdlets, you can configure various QoS-related parameters, such as traffic classification, priority flow control, and traffic class throughput scheduling.

For more information on using PowerShell Cmdlets, see the "[DCB Windows PowerShell User Scripting Guide](#)" in the Microsoft Technet Library.

To revert to standard BACS control over the Broadcom DCB feature set, uninstall the Microsoft QOS feature or disable Quality

of Service in the NDIS advance properties page.

 NOTE: Broadcom recommends that you do not install the DCB feature if SR-IOV will be used. If you install the DCB feature, be aware that selecting **Enable single-root I/O virtualization (SR-IOV)** in Virtual Switch Manager will force the underlying adapter into a DCB state in which OS DCB configuration will be ignored, and DCB configuration from BACS will be in effect with the exception that the user-configured **Networking Priority** value (non-zero) will not take effect, even though it appears that it is from BACS.

Please read all [Restrictions and Disclaimers](#).

[Back to Contents Page](#)

[Back to Contents Page](#)

SR-IOV: Broadcom NetXtreme II® Network Adapter User Guide

[Overview](#)[Enabling SR-IOV](#)

Overview

Virtualization of network controllers allows users to consolidate their networking hardware resources and run multiple virtual machines concurrently on consolidated hardware. Virtualization also provides the user a rich set of features such as I/O sharing, consolidation, isolation and migration, and simplified management with provisions for teaming and failover.

Virtualization can come at the cost of reduced performance due to hypervisor overhead. The PCI-SIG introduced the Single-Root I/O Virtualization (SR-IOV) specification to address these performance issues by creating a virtual function (VF), a lightweight PCIe function that can be directly assigned to a virtual machine (VM), bypassing the hypervisor layer for the main data movement.

Not all Broadcom adapters support SR-IOV; refer to your product documentation for details.

Enabling SR-IOV

Before attempting to enable SR-IOV, ensure that:

- The adapter hardware supports SR-IOV.
- SR-IOV is supported and enabled in the system BIOS.

To enable SR-IOV:

1. Enable the feature on the adapter:

In If using BACS:

- a. Select the network adapter in the **Explorer View** pane. Select the **Configuration** tab and select **SR-IOV Global Enable**.
- b. In the **SR-IOV VFs per PF** field, configure the number of SRIOV Virtual Functions (VFs) that the adapter can support per physical function, from 0 to 64 in increments of 8 (default = 16).
- c. In the **SR-IOV Max Chains per VF** field, configure the maximum number of transmit and receive queues (such as receive side scaling (RSS) queues) that can be used for each virtual function. The maximum is 16.

If using CCM:

- d. Select the SR-IOV-capable adapter from the Device List. On the Main Menu, select **Device Hardware Configuration**, then select **SR-IOV Enabled**.
- e. To configure the number of VFs that the adapter can support:

If **Multi-Function Mode** is set to **SF** (Single Function), then the "Number of VFs per PF" field displays, which you can set from 0 to 64 in increments of 8 (default = 16).

If **Multi-Function Mode** is set to **NPAR**, then display the Main Menu and select **NIC Partition Configuration**. Then, select the NPAR Function to configure and enter the appropriate value in the **Number of VFs per PF** field.

2. In Virtual Switch Manager, create a virtual NIC. Ensure that **Allow Management operating system to share the network adapter** is selected as you create the NIC.
3. In Virtual Switch Manager, select the virtual adapter and select **Hardware Acceleration** in the navigation pane. In the Single-root I/O virtualization section, select **Enable SR-IOV**.
4. Install the Broadcom drivers for the adapters detected in the VM. Use the latest drivers available from your vendor for the host OS (do not use the inbox drivers). The same driver version must be installed on the host and the VM.

To verify that SR-IOV is operational

1. Start the VM.
2. In Hyper-V Manager, select the adapter and select the VM in the Virtual Machines list.
3. Select the Networking tab at the bottom of the window and view the adapter status.

SR-IOV and Storage Functionality

Storage functionality (FCoE or iSCSI) can be enabled on an SR-IOV-enabled adapter. However, if storage is used on an NPAR-enabled physical function (PF), then the number of virtual functions for that PF is set to zero; therefore, SR-IOV is disabled on that PF.

This limitation applies only when the adapter is configured in NPAR mode. It is not relevant when the adapter is configured in single-function mode.

SR-IOV and Jumbo Packets

If SR-IOV is enabled on a virtual function (VF) on the adapter, ensure that the same jumbo packet settings is configured on both the VF and the Microsoft synthetic adapter. You can configure these values using Windows Device Manager > Advanced properties.

If there is a mismatch in the values, the SRIOV function will be shown the the Degraded state in Hyper-V > Networking Status.

[Back to Contents Page](#)

[Back to Contents Page](#)

Using Broadcom Advanced Control Suite 4: Broadcom NetXtreme II® Network Adapter User Guide

- [Broadcom Advanced Control Suite Overview](#)
- [Managing Ethernet Controller \(Port\)](#)
- [Starting Broadcom Advanced Control Suite](#)
- [Analyzing Cables in Windows](#)
- [BACS Interface](#)
- [Managing the LAN Device](#)
- [Configuring Preferences in Windows](#)
- [Viewing Resource Information](#)
- [Connecting to a Host](#)
- [Configuring Teaming](#)
- [Managing the Host](#)
- [Configuring With the Command Line Interface Utility](#)
- [Managing the Network Adapter](#)
- [Troubleshooting BACS](#)

Broadcom Advanced Control Suite Overview

Broadcom Advanced Control Suite (BACS) is an integrated utility that provides useful information about each network adapter that is installed in your system. BACS also enables you to perform detailed tests, diagnostics, and analyses on each adapter, as well as to view and modify property values and view traffic statistics for network objects. BACS operates on Windows and Linux operating systems.

Broadcom Advanced Server Program (BASP), which runs within Broadcom Advanced Control Suite, is used to configure teams for load balancing, fault tolerance, and virtual local area networks (VLANs). BASP functionality is available only on systems that use at least one Broadcom network adapter. BASP operates on Windows operating systems only.

 **NOTE:** Some features of BACS are relevant only to particular adapters or adapter families, such as NetXtreme I or NetXtreme II adapters. Because a single instance of BACS can be used to communicate with multiple hosts and adapter types, this document describes all BACS features.

The BACS application includes a graphical user interface and a command line interface (BACSCLI). BACS GUI and BACS CLI can operate on the following operating system families:

- Windows Server
- Linux Server

For information on the latest supported OS versions, refer to the release documentation provided with your software distribution.

Starting Broadcom Advanced Control Suite

In Control Panel, click **Broadcom Control Suite 4**, or click the BACS icon in the taskbar located at the bottom of the Windows or Windows Server desktop.

On Linux systems, you can double-click the BACS4 desktop icon, or access the BACS program from the task bar under **System Tools**. (If you are having difficulty launching BACS on a Linux system, see the related topic in [Troubleshooting BACS](#).)

BACS Interface

The BACS interface is comprised of the following regions:

- Explorer View pane
- Context View selector
- Context View pane
- Menu bar
- Description pane

By default, the Explorer View pane is docked and pinned on the left side of the main window, the Context View pane on the right, the

Context View selector below the menu bar, and the Description pane below the Context View pane. Drag the splitter between any two panes to vary the size of the panes.

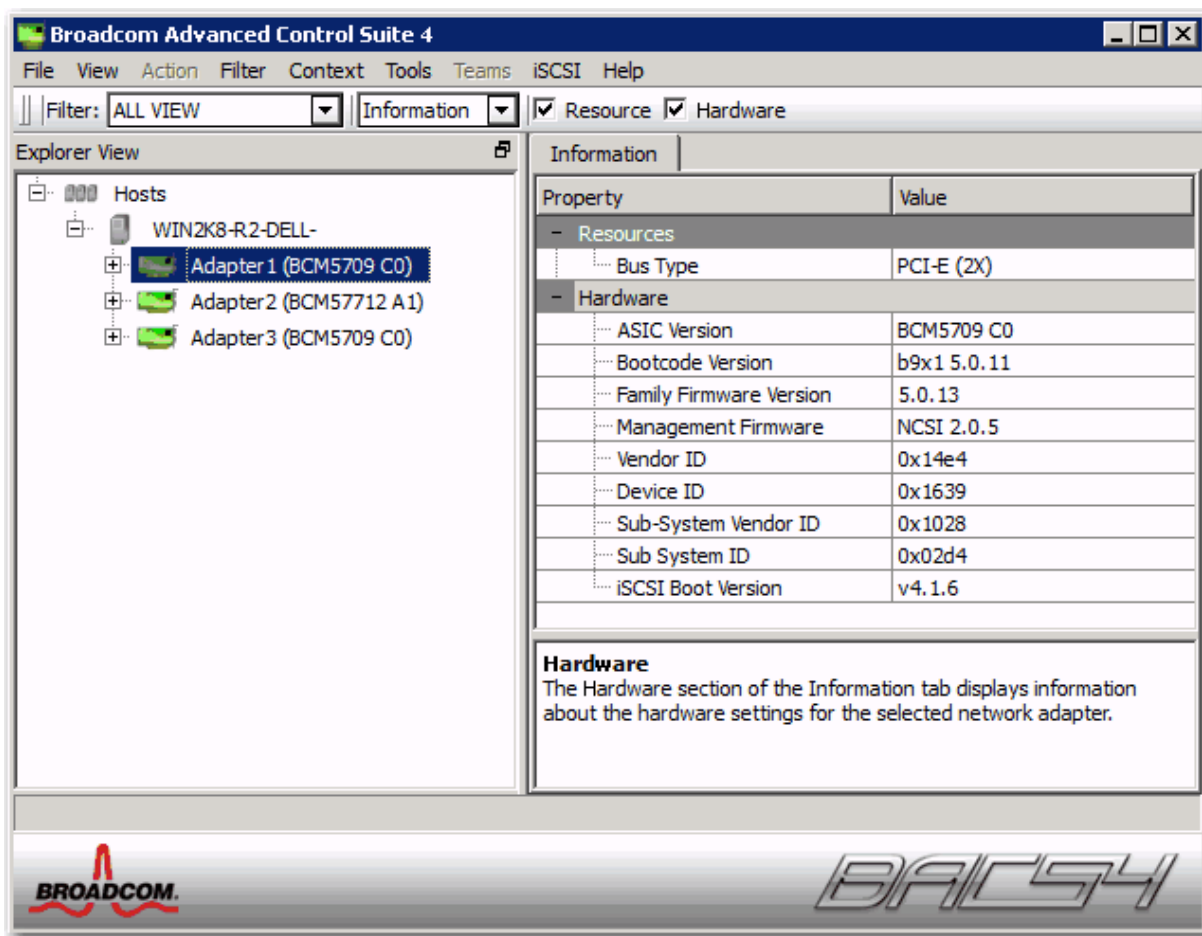

Explorer View Pane

You can dock and pin the Explorer View pane on the left side, right side, top, or bottom of the main window.

The Explorer View pane lists the objects that can be viewed, analyzed, tested, or configured by BACS. When an item is selected in the Explorer View pane, the tabs showing the information and options that are available for the item appear in the Context View pane.

The organization of this panel is designed to present the manageable objects in the same hierarchical manner as drivers and its subcomponents. This simplifies the management of various elements of the converged network interface controller (C-NIC). The top level of the hierarchy is the Host container, which lists all hosts managed by BACS. Below the hosts are the installed network adapters, with the manageable elements, such as physical port, VBD, NDIS, FCoE, and iSCSI below the adapters.

The icon next to each device in the Explorer View pane shows its status. An icon next to a device name that appears normal means the device is connected and working.

- **X.** A red "X" that appears on the device's icon indicates the device is currently not connected to the network.
- **Greyed out.** A device icon that appears greyed out indicates the device is currently disabled.

Context View Selector

The Context View selector appears below the menu bar and includes the filter and tab categories. Although you can expand and collapse the categories that appear on tabs in the Context View pane, you can alternatively display a category by selecting the box next to the category name.

Filter View

In a multiple-host environment using several C-NICs, there can be a large number of manageable elements per adapter that can be difficult and cumbersome to view, configure, and manage all elements. Use the filter to select a particular device function. Possible filter views include:

- All
- Team view
- NDIS view
- iSCSI view
- FCoE view
- iSCSI Target view
- FCoE Target view

Context View Pane

The Context View pane displays all the parameters that you can view for the object selected in the Explorer View pane. The parameters are grouped by tabs and categories, depending on the parameter type. The available tabs are Information, Configuration, Diagnostics, and Statistics. Because the BACS interface is context-sensitive, only the parameters that apply to the selected object can be viewed or configured in the Context View pane.

Menu Bar

The following appear on the menu bar, but because the menu items are context-sensitive, not all items will be available at all times:

File menu

- Team Save As: Saves the current team configurations to a file.
- Team Restore: Restores any saved team configuration from a file.

Action menu

- Remove Host: Removes the selected host.
- Refresh Host: Refreshes the selected host.

View menu

- Explorer View: Displays/hides the Explorer View pane.
- Tool Bar: Displays/hides the tool bar.
- Status Bar: Displays/hides the status bar.
- Broadcom Logo: Displays/hides the Broadcom Logo on BACS to optimize the maximum viewable space.

Tools menu

- Options: Used for configuring BACS preferences.

Teams (Windows only)

- Create Teams: Creates new teams with either the Teaming Wizard or in Advanced mode.
- Manage Teams: Manages existing teams with either the Teaming Wizard or in Advanced mode.

iSCSI menu

- Discovery Wizard: Locates targets and helps to configure the HBA.
- Manage Targets Wizard: Manages targets.
- Manage iSNS Servers: Manages Internet Storage Name Service (iSNS) servers to allow discovery, management, and configuration of iSCSI devices.
- Manage Discovery Portals: Manages iSCSI discovery portals.

Discovery Wizard

The Discovery Wizard is available from the iSCSI menu. Follow the prompts in the wizard to discover iSCSI targets via the SendTargets method or the Internet Storage Name Service (iSNS) server.

Manage Targets Wizard

The Manage Targets Wizard is available from the iSCSI menu. Follow the prompts in the wizard to add and remove targets, and to login or logout of a target.

Manage iSNS Servers

The Manage iSNS Servers window is available from the iSCSI menu. From this window, you can add or remove Internet Storage Name Service (iSNS) servers.

Manage Discovery Portals

The Manage Discovery Portals window is available from the iSCSI menu. From this window, you can add or remove iSCSI discovery portals.

Boot Configuration Wizard

The Boot Configuration Wizard is available by right-clicking a port. Follow the prompts in the wizard to configure the iSCSI boot parameters.

Hardware and Resource Configuration Wizard

The Hardware and Resource Configuration Wizard is used to configure properties for hardware resources. Follow the prompts in the wizard to configure hardware resources. You can preview the configuration before committing the changes.

Description Pane

The Description pane provides information, configuration instructions, and options for the selected parameter in the Context View pane.

Configuring Preferences in Windows

To enable or disable the BACS tray icon in Windows

On Windows systems, BACS places an icon in the Windows taskbar when the program is installed. Use the Options window to turn this icon on or off.

1. From the **Tools** menu, select **Options**.
2. Select or clear **Enable BACSTray** (the option is enabled by default).
3. Click **OK**.

Setting the teaming mode in Windows

1. From the **Tools** menu, select **Options**.
2. Select **Expert Mode** if you do not need the assistance of the teaming wizard to create teams; otherwise, select **Wizard Mode**.
3. Click **OK**.

Setting the Explorer View refresh time in Windows

1. From the **Tools** menu, select **Options**.
2. Select **Auto** to set the Explorer View refresh time to 5 seconds. Otherwise, select Custom and select a time, in seconds.
3. Click **OK**.

Connecting to a Host

You can add one or more Windows or Linux hosts to manage from BACS.

To add a local host

1. From the **Action** menu, click **Add Host**.
2. For both Windows and Linux hosts, do not change the default settings. The **User name** and **Password** are not required while connecting to the local host.
3. Select **Persist** if you want BACS to save the information for this host.
4. Click **OK**. BACS can now be used to view information and manage the host.

To add a remote host

1. From the **Action** menu, click **Add Host**.
2. Type the remote host's name or IP address in the **Host** box.
3. Select the protocol from the **Protocol** list. The protocol options for Windows are **WMI**, **WSMan**, or **Try All**. The protocol options for Linux are **CimXML**, **WSMan**, or **Try All**. The **Try All** option forces the GUI client to try all options.
4. Select the **HTTP** scheme, or the **HTTPS** scheme for added security.
5. Type the **Port Number** value you used to configure the host, if it is different than the default value of **5985**.
6. Type the **User name** and **Password**.
7. Select **Persist** if you want BACS to save the information for this host. The host will appear in the Explorer Pane whenever you reopen BACS, and you will not need to enter the host IP address or host name when connecting to the host. For security reasons, you must enter the **User name** and **Password** every time.
8. Click **OK**.

Managing the Host

At the host level, you can view host information and configure parameters from the following tabs:

- Information
- Configuration

To view host information

Select the host in the **Explorer View** pane, and then select the **Information** tab to view host-level information.

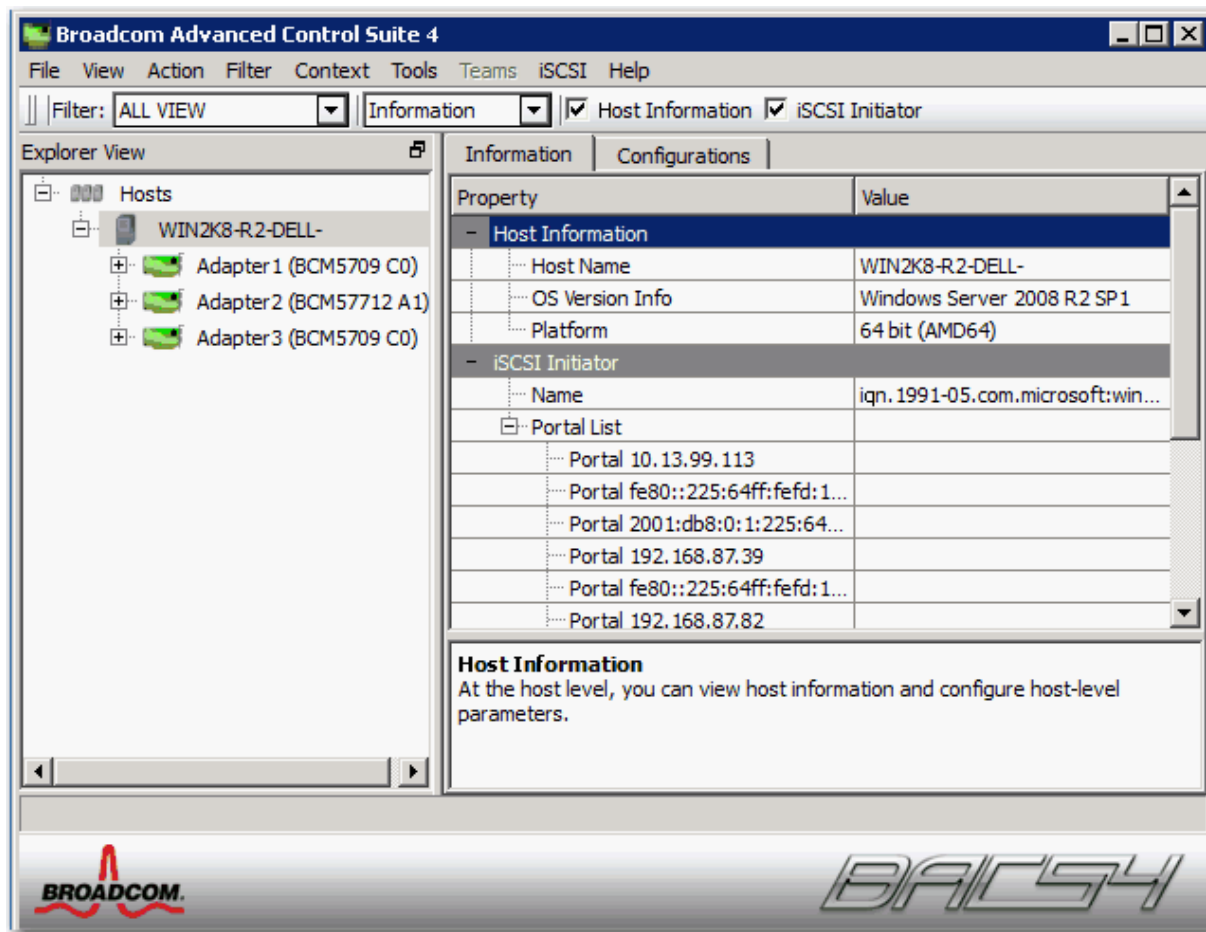

Information Tab: Host Information

Host Name

Displays the name of the host.

OS Version Info

Displays the operating system, including the version.

Platform

Displays the hardware architecture platform (for example, 32-bit or 64-bit)

Information Tab: iSCSI Initiator

The iSCSI Initiator section of the Information tab is available if iSCSI is enabled on the host.

Name

Displays the iSCSI initiator name in IQN format.

Portal List

Displays all iSCSI portal IP addresses configured on the selected host.

 **NOTE:** Some information may not be available for all Broadcom network adapters.

To configure the host

Select the host in the **Explorer View** pane, and then select the **Configuration** tab to configure host-level parameters.

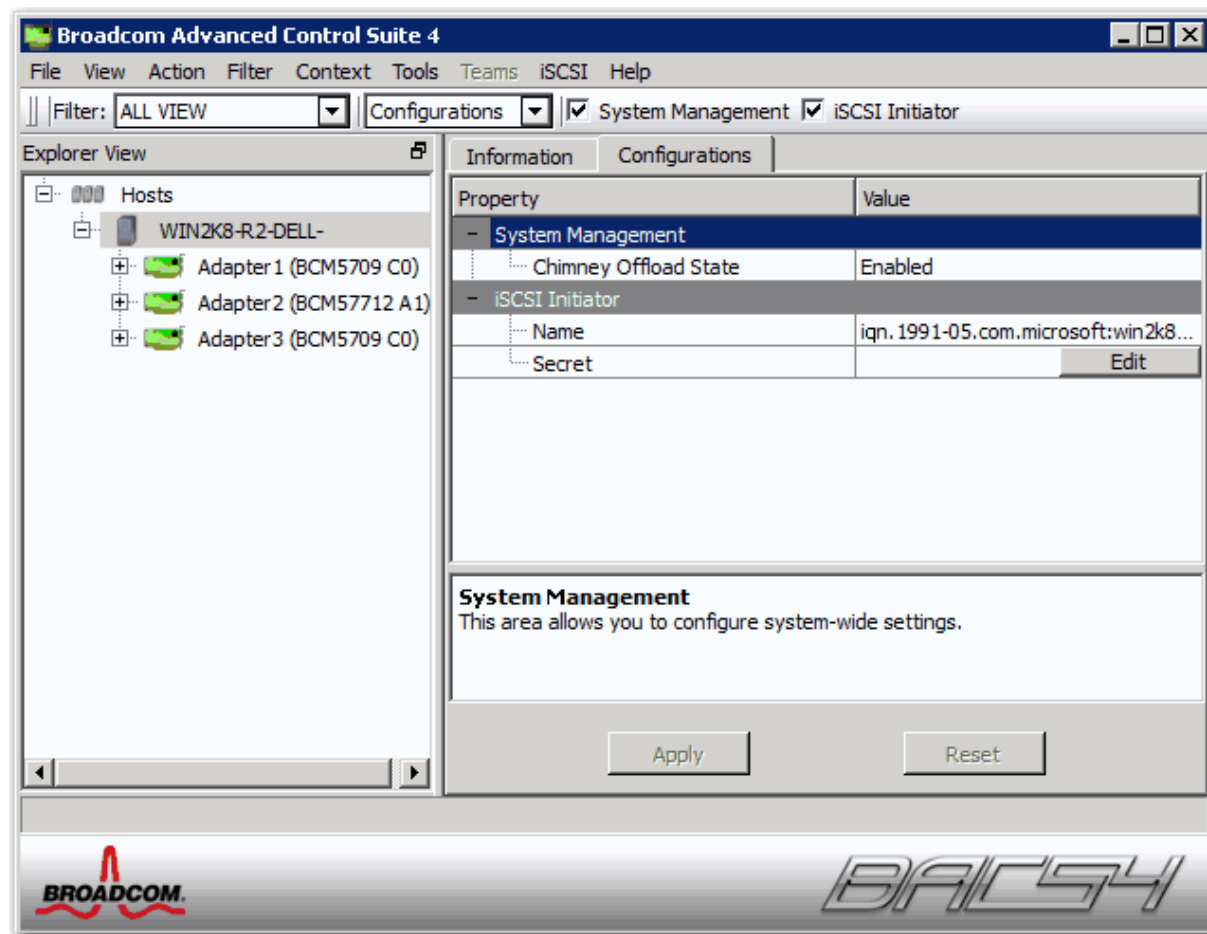

Configuration Tab: System Management

Chimney Offload State

Enable or disable chimney offload at the host level, rather than at the device level, and then click **Apply**.

Configuration Tab: iSCSI Initiator

Name

The current IQN name is displayed. Click the IQN name to modify the host's iSCSI initiator name, and then click **Apply**.

Managing the Network Adapter

The installed network adapters appear one level below the host in the hierarchical tree in the Explorer View pane. At the adapter level, you can view information and configure parameters from the following tabs:

- Information
- Configuration

Viewing Adapter Information

Select the network adapter in the **Explorer View** pane, and then select the **Information** tab to view adapter-level information.

The screenshot displays the Broadcom Advanced Control Suite 4 application window. The Explorer View pane on the left shows a hierarchical tree with 'Hosts' expanded to 'WIN2K8-R2-DELL-', which contains three network adapters: 'Adapter 1 (BCM5709 C0)', 'Adapter 2 (BCM57712 A1)', and 'Adapter 3 (BCM5709 C0)'. The 'Information' tab is selected, showing a table of properties and values for the selected adapter. Below the table, there is a 'Resource' section with a descriptive text.

Property	Value
Resources	
Bus Type	PCI-E (8X)
Slot Number	5
Hardware	
ASIC Version	BCM57712 A1
Bootcode Version	MFW1 6.4.17
Family Firmware Version	A1213GT6421.0
Vendor ID	0x14e4
Device ID	0x1662
Sub-System Vendor ID	0x14e4
Sub-System ID	0x1203
iSCSI Boot Version	v6.4.2
External Phy Firmware Vers...	aa0.511

Resource
The Resources section of the Information tab displays information about connections and other essential functions for the selected network adapter.

Viewing Resource Information

The **Resources** section of the **Information** tab displays information about connections and other essential functions for the selected network adapter.

NOTE: Some information may not be available for all Broadcom network adapters.

Information Tab: Resources

Bus Type

The type of input/output (I/O) interconnect used by the adapter.

Bridge

The bridge type, which is the PCI-E to PCI-X bridge. This information is only available for Broadcom NetXtreme II adapters.

Bridge Lanes

The number of PCI-E lanes connected to the bridge. This information is only available for Broadcom NetXtreme II adapters.

Bridge Speed

The clock speed on PCI-E bus. This information is only available for Broadcom NetXtreme II adapters.

Slot Number

The slot number on the system board occupied by the adapter. This item is not available for PCI Express type adapters.

Bus Speed

The bus clock signal frequency used by the adapter. This item is not available for PCI Express type adapters.

Bus Width

The number of bits that the bus can transfer at a single time to and from the adapter. This item is not available for PCI Express type adapters.

Bus Number

Indicates the number of the bus where the adapter is installed.

Device Number

The number assigned to the adapter by the operating system.

Function Number

The port number of the adapter. For a single-port adapter, the function number is 0. For a two-port adapter, the function number for the first port is 0, and the function number for the second port is 1.

Interrupt Request

The interrupt line number that is associated with the adapter. Valid numbers range from 2 to 25.

Memory Address

The memory mapped address that is assigned to the adapter. This value can never be 0.

MSI Version

This is the Message Signaled Interrupts (MSI) version being used. The option MSI corresponds to the PCI 2.2 specification that supports 32 messages and a single MSI address value. The option MSI-X corresponds to the PCI 3.0 specification that supports 2,048 messages and an independent message address for each message.

Viewing Hardware Information

The Hardware section of the **Information tab** displays information about the hardware settings for the selected network adapter.



NOTE: Some information may not be available for all Broadcom network adapters.

Information Tab: Hardware

ASIC Version

The chip version of the Broadcom adapter (this information is not available for adapters made by others).

Firmware Version

The firmware version of the Broadcom adapter (this information is not available for adapters made by others). This information is only available for Broadcom NetXtreme adapters.

Bootcode Version

The version of the boot code. This information is only available for Broadcom NetXtreme II adapters.

Family Firmware Version

The global firmware version that represents all firmware on the device.

Management Firmware

The firmware version installed on the system.

Vendor ID

The vendor ID.

Device ID

The adapter ID.

Subsystem Vendor ID

The subsystem vendor ID.

Subsystem ID

The subsystem ID.

iSCSI Boot Version

The version of the iSCSI Boot software initiator.

External PHY Firmware Version

The external PHY firmware version.

Configuring Adapter Parameters

Select the network adapter in the **Explorer View** pane, and then select the **Configuration** tab to configure adapter-level parameters.

Hardware and Resource Configuration Wizard: Port Configuration

Select a port to configure and then click **Next**.

Flow Control

The possible values are Auto, Tx Pause, Rx Pause, Tx/Rx pause, and Disable. The configuration is done at the port level and applies to all functions under the port. The flow control value is a default value for the port. The effective configuration can be different based on the switch port configuration and whether or not DCB/DCBX is enabled.

Link Speed

Configure the link speed. The default speed is 1Gb for 1Gb adapters and 10Gb for 10Gb adapters.

Managing Ethernet Controller (Port)

From BACS, you can group various traffic classes in to priority group and allocate bandwidth to each priority group.

When the Ethernet controller is selected in the Object Explorer panel, following four tabs will be displayed in the context view panel:

- Information Tab
- Configuration tab
- Statistics Tab
- Diagnostic Tab

Viewing Port Level Information

Selecting Ethernet controller in the object explorer will allow user to view various types of information at the port level.

1. Select PortX (where X is either 0 or 1) below Adapter in the object explorer.
2. Various components of the port will be displayed below port in the object explorer. You can click on the "+" icon near Port to expand or collapse the tree below.
3. Select Information tab in the context view panel on the right side.

Viewing Vital Signs

The **Vital Signs** section of the **Information** tab has useful information about the network adapters that are installed in your system, such as the link status of the adapter and general network connectivity.

To view Vital Signs information for any installed network adapter, select the name of the adapter listed in the Explorer View pane, then click the **Information** tab.



NOTES:

- Information about Broadcom network adapters may be more comprehensive than information about network adapters made by others.
- Some information may not be available for all Broadcom network adapters.

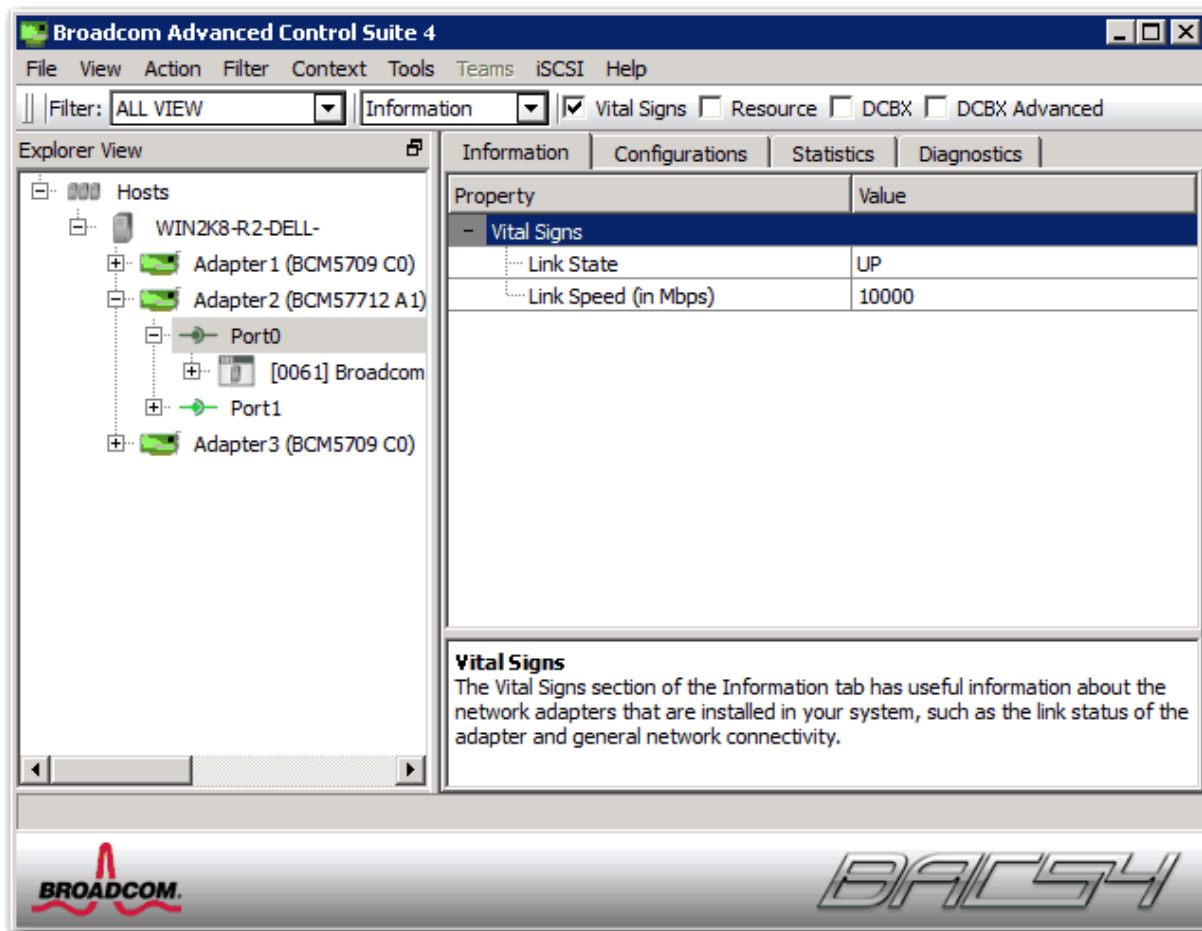

MAC Address

A physical MAC (media access control) address that is assigned to the adapter by the manufacturer. The physical address is never all 0s.

Permanent MAC Address

The unique hardware address assigned to the network adapter.

iSCSI MAC Address

If an iSCSI network adapter is loaded onto the system, this parameter will display the iSCSI MAC address.

IPv4 DHCP

The IP address is from a DHCP server if the value is Enable.

IP Address

The network address associated with the adapter. If the IP address is all 0s, the associated driver has not been bound with Internet Protocol (IP).

IPv6 DHCP

The IP address is from a DHCP server if the value is Enable.

IPv6 IP Address

The IPv6 network address associated with the adapter.

IPv6 Scope Id

Since local-use addresses can be reused, the Scope ID for link-local addresses specifies the link where the destination is located. The Scope ID for site-local addresses specifies the site where the destination is located. The Scope ID is relative to the sending host.

IPv6 Flow Info

The non-zero Flow Info is used to classify traffic flows. If Flow Info equals zero, then the packets are not a part of any flow.

Default Gateway

The default gateway value is the network address of the gateway that will be used by the management firmware for packets destined for hosts external to the local network segment.

Link Status

The status of the network link.

- **Up.** A link is established.
- **Down.** A link is not established.

Duplex

The adapter is operating in the indicated duplex mode.

Speed

The link speed of the adapter, in megabits per second.

Offload Capabilities

The offload capabilities supported by the adapter. This information is only available for Broadcom NetXtreme II adapters.

- **TOE.** TCP Offload Engine (TOE) allows simultaneous operation of up to 1024 fully offloaded TCP connections for 1-Gbps network adapters and 1880 fully offloaded TCP connections for 10-Gbps network adapters to the hardware.
- **iSCSI.** iSCSI offload for block-level transfer of data.
- **LSO.** Large Send Offload (LSO) prevents an upper level protocol such as TCP from breaking a large data packet into a series of smaller packets with headers appended to them.
- **CO.** Checksum Offload (CO) allows the TCP/IP/UDP checksums for send and receive traffic to be calculated by the adapter hardware rather than by the host CPU.

LiveLink IP Address

The network address of the LiveLink enabled adapter.

Local Connection

Identifies the module to which the blade server is attached.

- **Chassis SW.** Chassis switch module

- **Chassis PHY.** Pass-through module
- **None.** No modules attached

BASP State

Information about the status of the BASP application. This information is displayed only when there is a team (see [Configuring Teaming](#)).

Viewing NIC Partitioning Information

The NIC partitioning feature is available on Broadcom NetXtreme II adapters only.

The NIC Partitioning section of the **Information tab** displays information about the partitions for the selected network adapter.

To view NIC Partitioning for any installed network adapter, click the name of the adapter listed in the Explorer View pane, then click the Information tab.

 **NOTE:** Some information may not be available for all Broadcom network adapters.

NIC partitioning divides a Broadcom NetXtreme II 10 Gigabit Ethernet NIC into multiple virtual NICs by having multiple PCI physical functions per port. Each PCI function is associated with a different virtual NIC. To the OS and the network, each physical function appears as a separate NIC port. For more information, see the NIC Partitioning topic in the *Broadcom NetXtreme II Network Adapter User Guide*.

Number of Partitions

The number of partitions for the port. Each port can have from one to four partitions with each partition behaving as if it is an independent NIC port.

Network MAC Address

The MAC address of the port.

iSCSI MAC Address

If an iSCSI adapter is loaded onto the system, the iSCSI MAC address will appear.

Flow Control

The flow control setting of the port.

Physical Link Speed

The physical link speed of the port, either 1G or 10G.

Relative Bandwidth Weight (%)

- The relative bandwidth setting represents a weight or importance of a particular function. There are up to four functions per port. The weight is used to arbitrate between the functions in the event of congestion.
- The sum of all weights for the functions on a single port is either **0** or **100**.
- A value of **0** for all functions means that each function will be able to transmit at 25% of the physical link speed, not to exceed the **Maximum Bandwidth** setting.
- A value for a function between 1 and 100 represent a percentage of the physical link speed and is used by an internal arbitration logic as a input value (weight). A higher value will cause this function to transmit relatively more data, compared to a function (on the same port) that has defined a lower value.

Maximum Bandwidth (%)

- The maximum bandwidth setting defines an upper threshold value, ensuring that this limit will not be exceeded during transmission. The valid range for this value is between 1 and 100. The maximum bandwidth value is defined as a percentage of the physical link speed.
- It is possible for the sum of all maximum bandwidth values across the four functions of a single port to exceed the physical link speed value of either 10 Gbps or 1 Gbps. This case is considered as oversubscription. In a case where oversubscription congestion occurs on transmit, the **Relative Bandwidth Weight** value comes into effect.
- The **Maximum Bandwidth** setting is only valid in the context of Tx, but not Rx.

Testing the Network

The **Network Test** option on the **Diagnostics** tab lets you verify IP network connectivity. This test verifies if the driver is installed correctly and tests connectivity to a gateway or other specified IP address on the same subnet.

The network test uses TCP/IP to send ICMP packets to remote systems, then waits for a response. If a gateway is configured, the test automatically sends packets to that system. If a gateway is not configured or if the gateway is unreachable, the test prompts for a destination IP address.

NOTES:

- The network test option is not available on adapters that are grouped into a team (see [Configuring Teaming](#)).
- This feature can be used with Windows Server managed hosts only. It is not available for hosts operating on Linux or other OSes. You can, however use BACS on a Linux client to connect to a Windows Server host and run the network test utility.

To run the network test using the BACS GUI

1. Click the name of the adapter to test in the Explorer View pane.
2. From the **Select a test to run** list, select **Network Test**.
3. To change the destination IP address, select **IP address to ping**, then click the browse button (...). In the Network Test window, enter a Destination IP address, then click **OK**.
4. Click **Run**.

The results of the network test are displayed in the **Status** field.

To run the network test using the BACS CLI

You can use the following CLI command to perform a network diagnostic test for the specified target. This command is available for NDIS and virtual adapters.

```
BACSccli -t <target type> -f <target format> -i <target ID> networkdiag [-p <IP address>]
```

Examples:

1. The following command runs the network test for the current selected NDIS adapter.

```
BACSccli -t NDIS -f mac -i 0010181a1b1c "networkdiag -p 192.168.1.5"
```

2. The following command runs the network test for the current selected virtual adapter. Since there is no IP address specified, BACSccli will use gateway address for the test.

```
BACSccli -t VNIC -f mac -i 0010181a1b1c "networkdiag"
```

In Interactive mode, use the `list <view>` and `select <idx>` commands to select the desired target device. Use `networkdiag [-p <IP address>]` to run the network diagnostics test for the selected target.

Examples:

1. The following command runs the network test for the currently selected NDIS adapter.

```
networkdiag -p 192.168.1.5
```

2. The following command runs the network test for the current selected virtual adapter.

```
networkdiag
```

Running Diagnostic Tests in Windows

The **Diagnostic Tests** option on the **Diagnostics** tab lets you check the state of the physical components on a Broadcom network adapter. You can trigger the tests manually, or choose to have BACS continuously perform them. If the test are performed continuously, then the number of passes and fails in the **Result** field for each test increments every time the tests are performed. For example, if a test is performed four times and there are no fails, the value in the **Result** field for that test is 4/0. However, if there were 3 passes and 1 fail, the value in the **Result** field is 3/1.

NOTES:

- This feature can be used with Windows Server managed hosts only. It is not available for hosts operating on Linux or

other OSes. You can, however use BACS on a Linux client to connect to a Windows Server host and run the diagnostic test utility.

- You must have administrator privileges to run diagnostic tests.
- The network connection is temporarily lost while these tests are running.
- Some tests are not supported on all Broadcom adapters.

To run the diagnostic tests once using the BACS GUI

1. Click the name of the adapter to test in the Explorer View pane and select the Diagnostics tab.
2. From the **Select a test to run** list, select **Diagnostic Tests**.
3. Select the diagnostic tests you want to run. Click **Select All** to select all tests or **Clear All** to clear all test selections.
4. Select the number of times to run the tests from **Number of loops**.
5. Click **Run test(s)**.
6. In the error message window that warns of the network connection being temporarily interrupted, click **Yes**. The results are displayed in the **Result** field for each test.

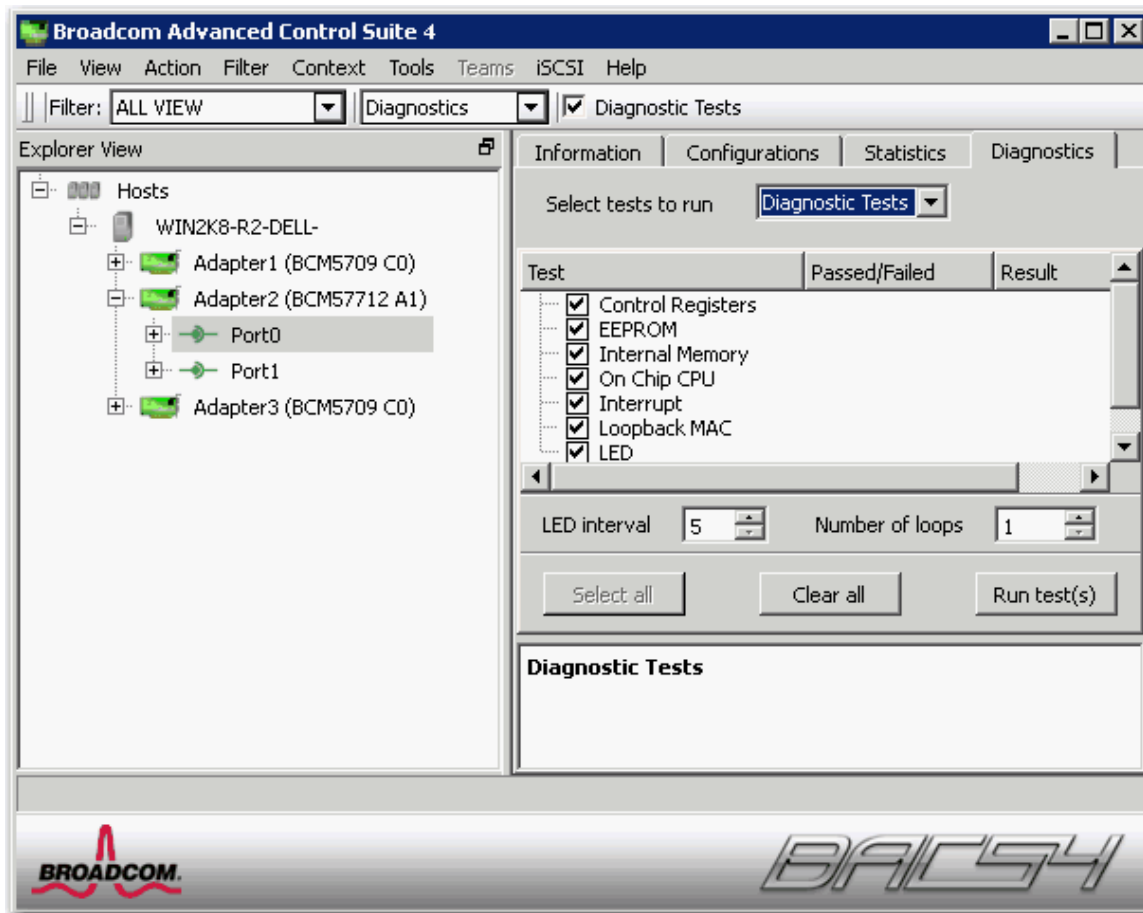

Control Registers

This test verifies the read and write capabilities of the network adapter registers by writing various values to the registers and verifying the results. The adapter driver uses these registers to perform network functions such as sending and receiving information. A test failure indicates that the adapter may not be working properly.

MII Registers

This test verifies the read and write capabilities of the registers of the physical layer (PHY). The physical layer is used to control the electrical signals on the wire and to configure network speeds such as 1000 Mbit/s.

EEPROM

This test verifies the content of the electrically erasable programmable read-only memory (EEPROM) by reading a portion of the EEPROM and computing the checksum. The test fails if the computed checksum is different from the checksum stored in the EEPROM.

An EEPROM image upgrade does not require a code change for this test.

Internal Memory

This test verifies that the internal memory of the adapter is functioning properly. The test writes patterned values to the memory and reads back the results. The test fails if an erroneous value is read back. The adapter cannot function if its internal memory is not functioning properly.

On-Chip CPU

This test verifies the operation of the internal CPUs in the adapter.

Interrupt

This test verifies that the Network Device Driver Interface Specification (NDIS) driver is able to receive interrupts from the adapter.

Loopback MAC and Loopback PHY

These tests verify that the NDIS driver is able to send packets to and receive packets from the adapter.

Test LED

This test causes all of the port LEDs to blink 5 times for the purpose of identifying the adapter.

To run the diagnostic tests using the BACS CLI

You can use the following CLI command to run diagnostics tests on a specified target. This command is available for physical device ports only:

```
BACSccli -t <target type> -f <target format> -i <target ID> "diag {[-c REG ] [-c MII ] [-c EEPROM] [-c MEM] [-c CPU] [-c INT] [-c MACLB ] [-c PHYLB] [-c LED] | [-c ALL]} [-l <cnt> ] [ -v <LEDIntv> ]"
```

Examples:

1. The following command displays all the diagnostics tests available for the current selected target.

```
BACSccli -t PHYPORTS -f bdf -i 01:00.00 "diag"
```

2. The following command runs the MII and LED tests for the selected target:

```
BACSccli -t PHYPORTS -f bdf -i 01:00.00 "diag -c MII -c LED"
```

3. The following command runs all the tests five times with an LED test interval of 8 ms for the selected target:

```
BACSccli -t PHYPORTS -f bdf -i 01:00.00 "diag -c all -l 5 -v 8"
```

In Interactive mode, use the `list <view>` and `select <idx>` commands to select the desired target device. Use the following command to run diagnostic tests for the selected target:

```
diag {[-c REG ] [-c MII ] [-c EEPROM] [-c MEM] [-c CPU] [-c INT] [-c MACLB ] [-c PHYLB] [-c LED] | [-c ALL]} [-l <cnt> ] [ -v <LEDIntv> ]
```

Examples:

1. The following command displays all the diagnostics tests available for the current selected target.

```
diag
```

2. The following command runs the MII and LED test for the selected target.

```
diag -c MII -c LED
```

3. The following command runs all the tests five times, with an LED test interval of 8 ms for the selected target.

```
diag -c all -l 5 -v 8
```

Analyzing Cables in Windows

The **Cable Analysis option** on the **Diagnostics** tab lets you monitor the conditions of each wire pair in an Ethernet Category 5 cable connection within an Ethernet network. The analysis measures the cable quality and compares it against the IEEE 802.3ab specification for compliance.

 NOTES:

- This feature can be used with Windows Server managed hosts only. It is not available for hosts operating on Linux or other OSes. You can, however use BACS on a Linux client to connect to a Windows Server host and run the cable analysis utility.
- You must have administrator privileges to run the cable analysis test.
- The network connection is temporarily lost during an analysis.
- This option is not available for NetXtreme II 10 GbE network adapters.
- This option is not available for all Broadcom network adapters.
- This option is available for Broadcom NetXtreme II VBD drivers.

To run a cable analysis using BACS GUI

1. Connect the cable to a port on a switch where the port is set to **Auto** and the Speed & Duplex driver settings are also set to **Auto**.
2. Click the name of the adapter to test in the Explorer View pane.

 NOTE: For Broadcom NetXtreme II adapters, select a VBD driver; for other adapters, select an NDIS driver.

3. From the **Select a test to run** list, select **Cable Analysis**.
4. Click **Run**.
5. In the error message window that warns of the network connection being temporarily interrupted, click **Yes**.

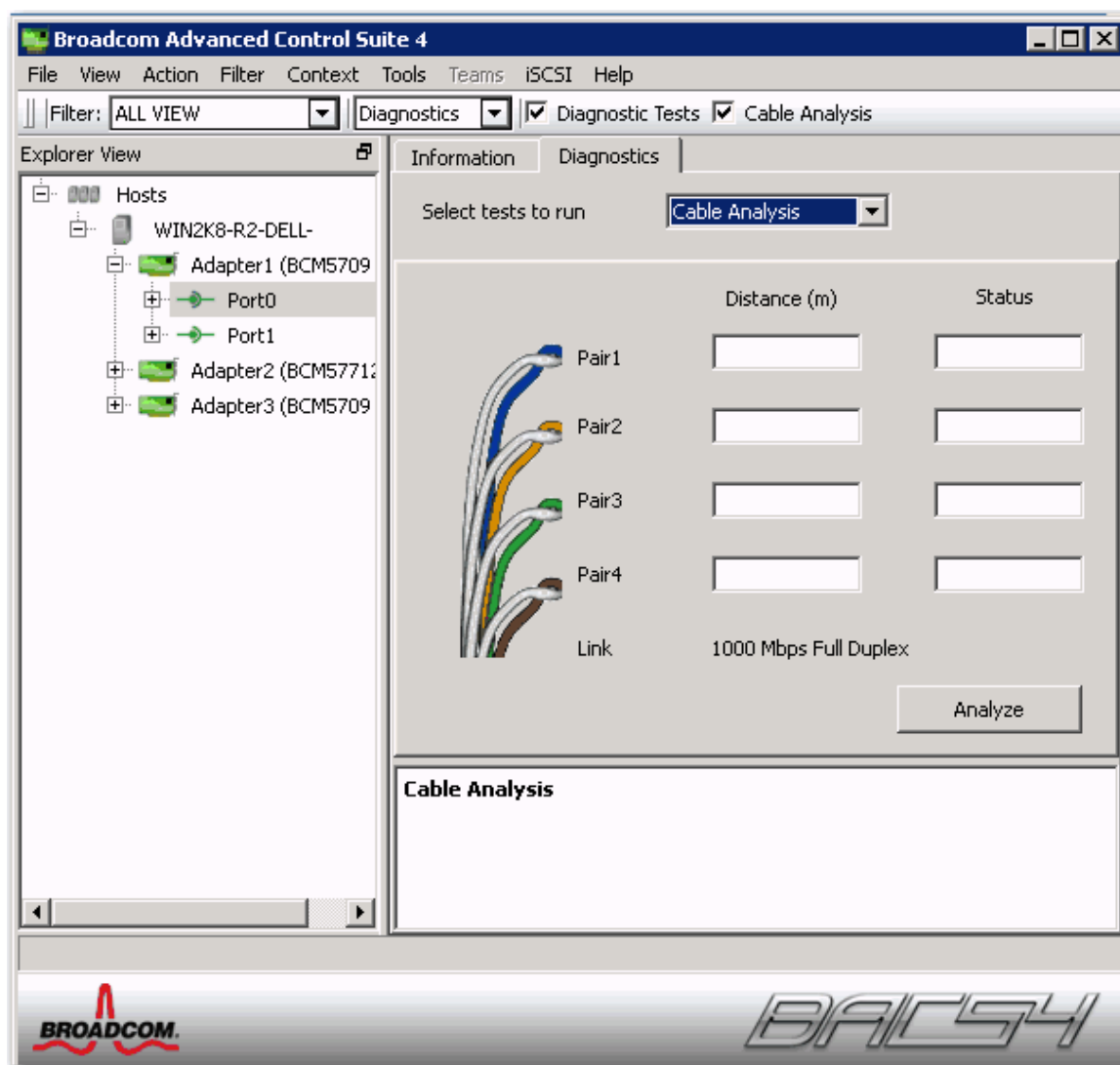

Distance

The valid cable length in meters (except when the **Noise** result is returned).

Status

The result of the analysis for the indicated pair.

- **Good.** Good cable/PCB signal paths, but no gigabit link.
- **Crossed.** Pin short or crosstalk along two or more cable/PCB signal paths.
- **Open.** One or both pins are open for a twisted pair.
- **Short.** Two pins from the same twisted pair are shorted together.
- **Noise.** Persistent noise present (most likely caused by Forced 10/100).
- **GB Link.** Gigabit link is up and running.
- **N/A.** Algorithm failed to reach a conclusion.

Link

The link connection speed and mode.

Status

The status after the test is run, either completed or failed.

There are several factors that could have an effect on the test results:

- **Link partner.** Various switch and hub manufacturers implement different PHYs. Some PHYs are not IEEE compliant.
- **Cable quality.** Category 3, 4, 5, and 6 may affect the test results.
- **Electrical interference.** The testing environment may affect the test results.

To run a cable analysis using BACS CLI

You can use the following CLI commands to run cable analysis for the specified target. This command is available for physical device ports only.

```
BACSccli -t <target type> -f <target format> -i <target ID> cablediag
```

Example:

1. The following command runs the cable diagnostics test for the current selected target.

```
BACSccli -t PHYPORTS -f bdf -i 01:00.00 "cablediag"
```

In Interactive mode, use the `list <view>` and `select <idx>` commands to select the desired target device. Use the `cablediag` command to run the cable analysis test for the selected target.

Example:

1. The following command runs the cable diagnostics test for the currently selected NDIS adapter.

```
cablediag
```

Managing the LAN Device

The LAN function represents the Ethernet (NDIS) functionality available under the PCI Function. User can view current values of various NDIS driver parameters, configure NDIS driver parameters, view attached FCoE targets and LUN information by selecting FCoE object in object explorer panel.

The available tabs for the NDIS function are as follows:

At the NDIS level, you can view parameters, configure parameters, and run tests from the following tabs:

- Information
- Configuration
- Diagnostics
- Statistics

Viewing NDIS Information

Select the NDIS driver in the **Explorer View** pane, and then select the **Information** tab to view NDIS-level information.

NOTES:

- Information about Broadcom network adapters may be more comprehensive than information about network adapters made by others.
- Some information may not be available for all Broadcom network adapters.

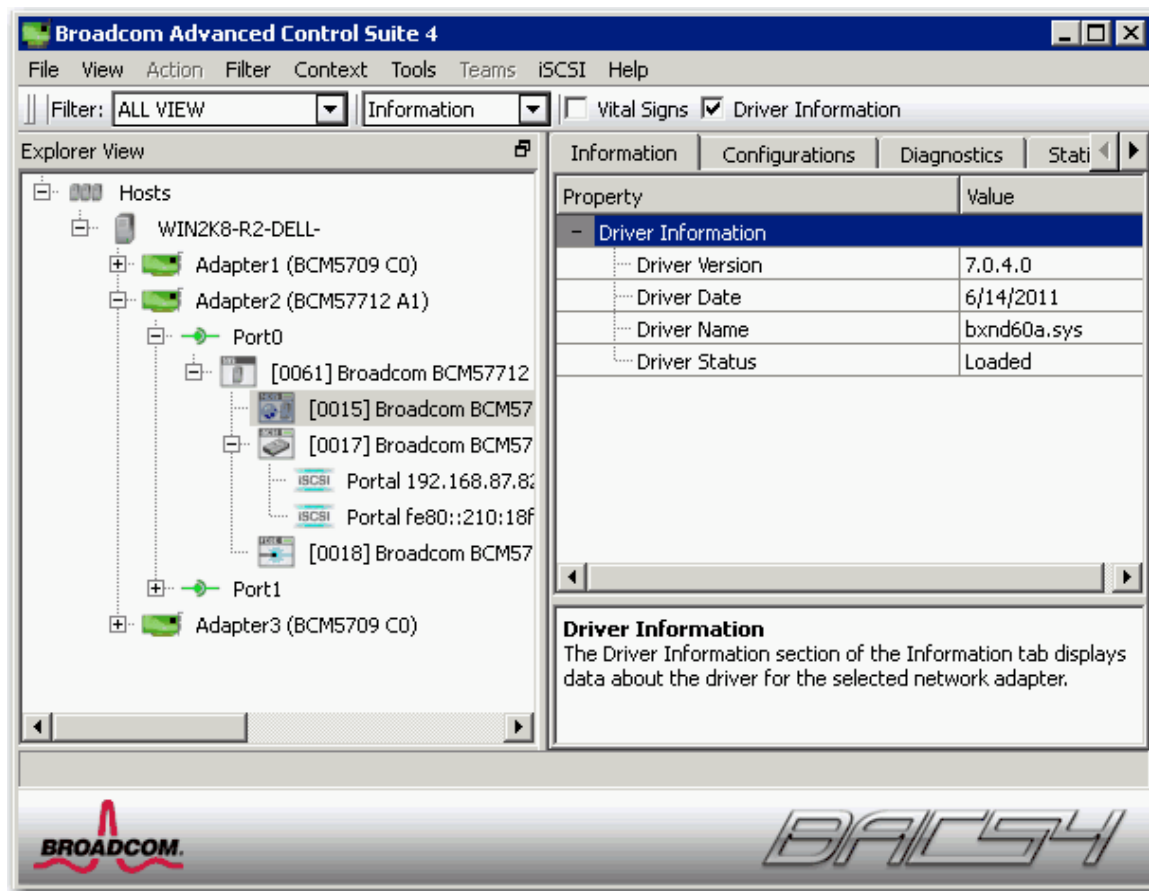

Viewing Driver Information

Information Tab: Driver Information

Driver Status

The status of the adapter driver.

- Loaded.** Normal operating mode. The adapter driver has been loaded by the OS and is functioning.
- Not Loaded.** The driver associated with the adapter has not been loaded by the OS.
- Information Not Available.** The value is not obtainable from the driver that is associated with the adapter.

Driver Name

The file name of the adapter driver.

Driver Version

The current version of the adapter driver.

Driver Date

The creation date of the adapter driver.

Information Tab: Vital Signs

IP Address

The network address associated with the adapter. If the IP address is all 0s, the associated driver has not been bound with Internet Protocol (IP).

IPv6 IP Address

The IPv6 network address associated with the adapter.

MAC Address

A physical MAC (media access control) address that is assigned to the adapter by the manufacturer. The physical address is never all 0s.

Permanent MAC Address

The unique hardware address assigned to the network adapter.

Offload Capabilities

The offload capabilities supported by the adapter. This information is only available for Broadcom NetXtreme II adapters.

- **TOE**. TCP Offload Engine (TOE) allows simultaneous operation of up to 1024 fully offloaded TCP connections for 1-Gbps network adapters and 1880 fully offloaded TCP connections for 10-Gbps network adapters to the hardware.
- **iSCSI**. iSCSI offload for block-level transfer of data.
- **LSO**. Large Send Offload (LSO) prevents an upper level protocol such as TCP from breaking a large data packet into a series of smaller packets with headers appended to them.
- **CO**. Checksum Offload (CO) allows the TCP/IP/UDP checksums for send and receive traffic to be calculated by the adapter hardware rather than by the host CPU.

Information Tab: SR-IOV Switch Information

Number of HW Available

Configure the number of available HW.

Number of Available VFs

Configure the number of available Virtual Functions (VF).

Max VF Chains Per VFs

Enter the number of maximum chains per Virtual Function (VF).

VF Chains Pool Size

Enter the pool size of Virtual Function (VF) chains.

Switch Friendly Name

Enter the switch-friendly name.

Configuring the NDIS Driver

Select the NDIS driver in the **Explorer View** pane, and then select the **Configuration** tab to configure NDIS-level parameters. After making changes, click **Apply** to confirm the changes to all properties. Click **Reset** to return the properties to their original values. Click **Defaults** to restore all settings to their default values.

NOTES:

- Clicking **Reset** after clicking **Defaults**, but before clicking **Apply**, will purge all values.
- **Apply** must be clicked to make changes go into effect.
- Any changes to existing settings will be lost upon clicking **Defaults**.

 NOTES:

- You must have administrator privileges to change the values for a property.
- The list of available properties for your particular adapter may be different.
- Some properties may not be available for all Broadcom network adapters.
- If an adapter is included as a member of a team and you change any advanced property, then you must rebuild the team to ensure that the team's advanced properties are properly set.

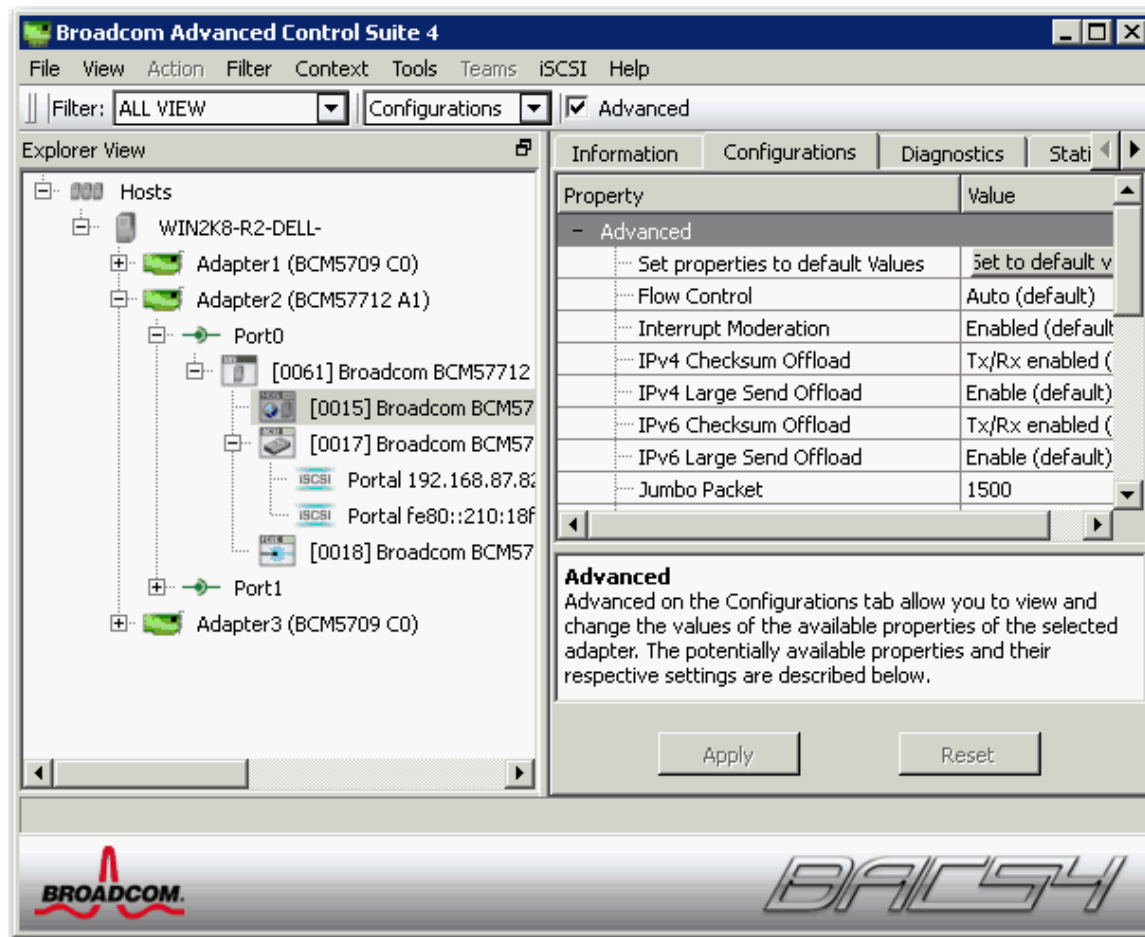

Configuration Tab: Advanced

Ethernet@Wirespeed

Enables a Gigabit Ethernet adapter to establish a link at a lower speed when only two pairs of wires are available in the cabling plant. The default setting for this property is Enabled.

Flow Control

Enables or disables the receipt or transmission of PAUSE frames. PAUSE frames allow the network adapter and a switch to control the transmit rate. The side that is receiving the PAUSE frame momentarily stops transmitting. By enabling TOE, network performance improves, but with the increased performance, TOE performance is more susceptible to packet loss when flow control is disabled. Enable flow control to reduce the number of packets lost.

 NOTE: If **Jumbo Packet** is set to 5000 bytes or greater on network adapters that support 10 Gbps link speed, ensure that **Flow Control** is set to **Auto** to prevent the system performance from performing at less than optimal levels. This limitation exists on a per-port basis.

- **Auto** (default). Receive and transmit PAUSE frame functionality are optimized. This option indicates that the adapter automatically adjusts the flow control settings for optimal performance, and its purpose is not enabling auto negotiation of the flow control parameters.
- **Disable**. Receive and transmit PAUSE frame functionality are disabled.
- **Rx Enabled**. Receive PAUSE frame is enabled.

- **Rx & Tx Enabled.** Receive and transmit PAUSE frame are enabled.
- **Tx Enabled.** Transmit PAUSE frame is enabled.

IPv4 Checksum Offload

Normally, the checksum function is computed by the protocol stack. When you select one of the Checksum Offload property values (other than None), the checksum can be computed by the network adapter.

- **Rx Enabled.** Enables receive TCP/IP/UDP checksum offload.
- **Tx Enabled.** Enables transmit TCP/IP/UDP checksum offload.
- **Tx/Rx Enabled** (default). Enables transmit and receive TCP/IP/UDP checksum offload.
- **None.** Disables checksum offload.

IPv4 Large Send Offload

Normally, the TCP segmentation is done by the protocol stack. When you enable the Large Send Offload property, the TCP segmentation can be done by the network adapter. The default setting for this property is Enabled. This property is only available for Broadcom NetXtreme II adapters.

IPv6 Checksum Offload

Normally, the checksum function is computed by the protocol stack. When you select one of the Checksum Offload property values (other than None), the checksum can be computed by the network adapter.

- **Rx Enabled.** Enables receive TCP/IP/UDP checksum offload.
- **Tx Enabled.** Enables transmit TCP/IP/UDP checksum offload.
- **Tx/Rx Enabled** (default). Enables transmit and receive TCP/IP/UDP checksum offload.
- **None.** Disables checksum offload.

IPv6 Large Send Offload

Normally, the TCP segmentation is done by the protocol stack. When you enable the Large Send Offload property, the TCP segmentation can be done by the network adapter. The default setting for this property is Enabled. This property is only available for Broadcom NetXtreme II adapters.

Jumbo Packet

Enables the network adapter to transmit and receive oversized Ethernet frames that are greater than 1514 bytes, but less than or equal to 9000 bytes in length (9600 bytes for network adapters that operate at 10 Gbps). This property requires the presence of a switch that is able to process jumbo frames. This property is only available for Broadcom NetXtreme II adapters.

Frame size is set at 1500 bytes by default. To increase the size of the received frames, raise the byte quantity in 500-byte increments.

 **NOTE:** If **Jumbo Packet** is set to 5000 bytes or greater on network adapters that support 10 Gbps link speed, ensure that **Flow Control** is set to **Auto** to prevent the system performance from performing at less than optimal levels. This limitation exists on a per-port basis.

 **NOTE:** If SR-IOV is enabled on a virtual function (VF) on the adapter, ensure that the same jumbo packet settings is configured on both the VF and the Microsoft synthetic adapter. You can configure these values using Windows Device Manager > Advanced properties.

If there is a mismatch in the values, the SRIOV function will be shown the the Degraded state in Hyper-V > Networking Status.

LSO & Jumbo Frames

Enables the network adapter to transmit and receive oversized Ethernet frames that are greater than 1514 bytes, but less than 9000 bytes in length. This property requires the presence of a switch that is able to process Jumbo frames. This information is available for some Broadcom NetXtreme adapters and is not available for all Broadcom NetXtreme II adapters.

Frame size is set at 1500 bytes by default by selecting the **LSO Enabled, Jumbo Off** option.

 **NOTE:** Jumbo Frames and Large Send Offload (LSO) are mutually-exclusive properties.

Normally, the TCP segmentation is done by the protocol stack. When you enable the Large Send Offload (LSO) property, the TCP segmentation can be done by the network adapter.

- **Both Disabled**. LSO & Jumbo frames are both disabled.
- **LSO Enabled, Jumbo Off** (default). LSO enabled and jumbo frames disabled.
- **LSO Off, Jumbo 3000**. Frame size of 3000 bytes and LSO off.
- **LSO Off, Jumbo 4500**. Frame size of 4500 bytes and LSO off.
- **LSO Off, Jumbo 6000**. Frame size of 6000 bytes and LSO off.
- **LSO Off, Jumbo 7500**. Frame size of 7500 bytes and LSO off.
- **LSO Off, Jumbo 9000**. Frame size of 9000 bytes and LSO off.

Locally Administered Address

The Locally Administered Address is a user-defined MAC address that is used in place of the MAC address originally assigned to the network adapter. Every adapter in the network must have its own unique MAC address. This locally administered address consists of a 12-digit hexadecimal number.

- **Value**. Assigns a unique node address for the adapter.
- **Not Present** (default). Uses the factory-assigned node address on the adapter.

The appropriate assigned ranges and exceptions for the locally administered address include the following:

- The range is 00:00:00:00:00:01 to FF:FF:FF:FF:FF:FD.
- Do not use a multicast address (least significant bit of the high byte = 1).
- Do not use all 0s or all Fs.
- Do not assign a Locally Administered Address on any physical adapter that is a member of a team.
- Do not assign a Locally Administered Address on any iSCSI boot-enabled device.

 **NOTE:** In some cases, network devices will allow a different combination of hexadecimal and alphanumeric characters than what is entered, which could result in an invalid MAC address. If you assign an address, confirm the assigned address using the ipconfig utility at the DOS prompt.

Receive Side Scaling

Allows configuring network load balancing across multiple CPUs. The default setting for this property is Enabled.

Switch Configuration.

Allows configuring of the connected switch for the network adapters.

 **NOTE:** Switch Configuration only applies to blade configurations.

- **SW_Config_10G** (default). Sets the switch speed to 10 Gbit/s.
- **SW_Config_1G**. Sets the switch speed to 1 Gbit/s.

Speed & Duplex

The Speed & Duplex property sets the connection speed and mode to that of the network. Note that Full-Duplex mode allows the adapter to transmit and receive network data simultaneously.

- **10 Mb Full**. Sets the speed at 10 Mbit/s and the mode to Full-Duplex.
- **10 Mb Half**. Sets the speed at 10 Mbit/s and the mode to Half-Duplex.
- **100 Mb Full**. Sets the speed at 100 Mbit/s and the mode to Full-Duplex.
- **100 Mb Half**. Sets the speed at 100 Mbit/s and the mode to Half-Duplex.
- **1 Gb Full**. Sets the speed at 1000 Mb Full-Duplex mode only. Not available for 1 Gb ports.
- **10 GB Full**. Sets the speed to 10 Gbit/s and the mode to Full-Duplex. Not available for 1 Gb ports.
- **Auto** (default). Sets the speed and mode for optimum network connection (recommended).

NOTES:

- Auto is the recommended setting. This setting allows the network adapter to dynamically detect the line speed of the network. Whenever the network capability changes, the network adapter automatically detects and adjusts to the new line speed and duplex mode. A speed of 1 Gbit/s is enabled by selecting Auto, when that speed is supported.
- 1 Gb Full Auto must be attached to a link partner that is also capable of a 1 Gb connection. Since the connection is

limited to a 1 Gb connection only, the Ethernet@Wirespeed feature will be disabled. If the link partner supports a 1 Gb connection only, the Wake on LAN feature may not work. Additionally, management traffic (IPMI or UMP) in the absence of an operating system may also be affected.

- 10 Mb Half and 100 Mb Half settings force the network adapter to connect to the network in Half-Duplex mode. Note that the network adapter may not function if the network is not configured to operate at the same mode.
- 10 Mb Full and 100 Mb Full settings force the network adapter to connect to the network in Full-Duplex mode. The network adapter may not function if the network is not configured to operate at the same mode.
- 1 Gb copper ports cannot be forced to 1 Gb.

Speed & Duplex (SerDes)

- **1 Gb Full**. Forces the speed to 1 Gb Full based on a matching setting for its link partner.
- **Auto** (default). Sets the speed to auto-negotiate with its link partner at the highest matching speed.
- **Auto with 1Gb Fallback Full**. Sets the speed to auto-negotiate with its link partner, but if the attached link partner is forced at 1 Gbit/s, it will fall back to this mode.
- **Hardware Default**. Sets the speed to negotiate according to the setting specified by the manufacturer (see manufacturer documentation for more information).

Wake Up Capabilities

Enables the network adapter to wake up from a low-power mode when it receives a network wake-up frame. Two types of wake-up frames are possible: Magic Packet™ and Wake Up Frame. This property is only available for Broadcom NetXtreme adapters.

- **Both** (default). Selects both Magic Packet and Wake Up Frame as wake-up frames.
- **Magic Packet**. Selects Magic Packet as the wake-up frame.
- **None**. Selects no wake-up frame.
- **Wake Up Frame**. Selects Wake Up Frame as the wake-up frame and allows the network adapter to wake the system when an event such as a ping or an Address Resolution Protocol (ARP) request is received. This option works in conjunction with the operating system power mode saving and does not work if the Power Save setting does not enable WOL.

WOL Speed

Sets the speed at which the network adapter connects to the network while the network adapter is in Wake on LAN mode. By default, the WOL Speed property is set to Auto. This property is only available for Broadcom NetXtreme adapters.

- **10 Mb**. Sets the speed to 10 Mbit/s. This is the network speed when the system is in a standby mode awaiting a wake-up frame.
- **100 Mb**. Sets the speed to 100 Mbit/s.
- **Auto** (default). Sets the speed for optimum network connection.

NOTES:

- Wake on LAN is supported at 10 Mbit/s or 100 Mbit/s.
- Wake on LAN is supported on only one adapter in the system at a time.

Priority & VLAN

Allows enabling both the prioritization of network traffic and VLAN tagging. VLAN tagging only occurs when the VLAN ID setting is configured with a value other than 0 (zero).

- **Priority & VLAN Enabled (default)**. Allows for packet prioritization and VLAN tagging.
- **Priority & VLAN Disabled**. Prevents packet prioritization and VLAN tagging.
- **Priority Enabled**. Allows packet prioritization only.
- **VLAN Enabled**. Allows VLAN tagging only.

 NOTE: If an intermediate driver is managing the network adapter for VLAN tagging, the **Priority & VLAN Disabled** and **Priority Enabled** settings should not be used. Use the **Priority & VLAN Enabled** setting and change the **VLAN ID** to 0 (zero).

VLAN ID

Enables VLAN tagging and configures the VLAN ID when **Priority & VLAN Enabled** is selected as the **Priority & VLAN** setting. The range for the VLAN ID is 1 to 4094 and must match the VLAN tag value on the connected switch. A value of 0 (default) in this field

disables VLAN tagging.

Risk Assessment of VLAN Tagging through the NDIS Miniport Driver

Broadcom's NDIS 6.0 miniport driver provides the means to allow a system containing a Broadcom adapter to connect to a tagged VLAN. On Windows XP systems, this support was only provided through the use of an intermediate driver (e.g., Broadcom Advanced Server Program - BASP). Unlike BASP, however, the NDIS 6 driver's support for VLAN participation is only for a single VLAN ID.

Also unlike BASP, the NDIS 6.0 driver only provides VLAN tagging of the outbound packet, but does not provide filtering of incoming packets based on VLAN ID membership. This is the default behavior of all miniport drivers. While the lack of filtering packets based on VLAN membership may present a security issue, the following provides a risk assessment based on this driver limitation for an IPv4 network:

A properly configured network that has multiple VLANs should maintain separate IP segments for each VLAN. This is necessary since outbound traffic relies on the routing table to identify which adapter (virtual or physical) to pass traffic through and does not determine which adapter based on VLAN membership.

Since support for VLAN tagging on Broadcom's NDIS 6.0 driver is limited to transmit (Tx) traffic only, there is a risk of inbound traffic (Rx) from a different VLAN being passed up to the operating system. However, based on the premise of a properly configured network above, the IP segmentation and/or the switch VLAN configuration may provide additional filtration to limit the risk.

In a back-to-back connection scenario, two computers on the same IP segment may be able to communicate regardless of their VLAN configuration since no filtration of VLAN membership is occurring. However, this scenario assumes that the security may already be breached since this connection type is not typical in a VLAN environment.

If the risk above is not desirable and filtering of VLAN ID membership is required, then support through an intermediate driver would be necessary.

iSCSI Crash Dump

Crash dump is used to collect information on adapters that were booted remotely using iSCSI. To enable crash dump, set to Enable and reboot the system. If you perform an upgrade of the device drivers, re-enable **iSCSI Crash Dump**. If iSCSI Boot is configured to boot in the HBA path, then this parameter cannot be changed.

Number of Receive Descriptors

The number of receive descriptors with options of Default, Minimum, and Maximum. Receive descriptors are data segments that allow the network adapter to allocate receive packets to memory.

Number of Transmit Descriptors

The number of transmit descriptors with value options from 100 to 600 with 200 being the default value. Transmit descriptors are data segments that allow the network adapter to monitor transmit packets in the system memory.

RSS Queues

Allows configuring RSS queues from 1 to 4. Options are RSS 1 Queue, RSS 2 Queue, and RSS 4 Queue.

Interrupt Moderation

Enables interrupt moderation, which limits the rate of interrupt to the CPU during packet transmission and packet reception. The disabled option allows one interrupt for every packet transmission and packet reception. Enable is the default option.

Number of RSS Queues

Allows configuring RSS queues. For 1 Gbps network adapters, the RSS queue options are Auto (default), 2, 4, and 8. For 10 Gbps network adapters, the RSS queue options are Auto (default), 2, 4, 8, and 16.

Receive Buffers

The number of receive buffers. Receive buffers are data segments that allow the network adapter to allocate receive packets to memory. For 1 Gbps adapters, the range of valid receive buffers is 50 to 5000 in increments of 1 with 750 receive buffers as the default value.

Receive Buffers (0=Auto)

The number of receive buffers. Receive buffers are data segments that allow the network adapter to allocate receive packets to memory. For 10 Gbps adapters, the range of valid receive buffers is 0 to 3000 in increments of 50 with 0 receive buffers as the

default value.

Transmit Buffers (0=Auto)

The number of transmit buffers. Transmit buffers are data segments that allow the network adapter to monitor transmit packets in the system memory. The range of valid transmit buffers is 0 to 5000 in increments of 1 with 250 transmit buffers as the default value.

TCP Connection Offload (IPv4)

Enables and disables TOE offload when using the IPv4 protocol. The default is Enabled.

TCP Connection Offload (IPv6)

Enables and disables TOE offload when using the IPv6 protocol. The default is Enabled.

Pause on Exhausted Host Ring

For BCM57711 and BCM57712 network adapters, there are two possible scenarios that can trigger pause frames to be generated: a host ring buffer is exhausted or the on-chip buffers are depleted. With RSS enabled inside the system, it is possible to achieve better Ethernet throughput if no pause frames are being generated in a case where a host ring buffer (of multiple RSS rings) is exhausted. The default is Disabled.

Quality of Service

Enables Quality of Service (QoS) to provide different priorities to different applications.

Recv Segment Coalescing (IPv4)

Enable Receive Segment Coalescing (IPv4). Receive Segment Coalescing is an offload technology that reduces CPU utilization for network processing on the receive side by offloading tasks from the CPU to a network adapter.

Recv Segment Coalescing (IPv6)

Enable Receive Segment Coalescing (IPv6). Receive Segment Coalescing is an offload technology that reduces CPU utilization for network processing on the receive side by offloading tasks from the CPU to a network adapter.

SR-IOV

Enables Single Root I/O Virtualization (SR-IOV).

Viewing Resource Information

The **Resources** section of the **Information** tab displays information about connections and other essential functions for the selected network adapter.



NOTE: Some information may not be available for all Broadcom network adapters.

Information Tab: Resources

Bus Type

The type of input/output (I/O) interconnect used by the adapter.

Adapters Supporting Remote PHY

The following properties are specific to blade servers using a NetXtreme II BCM5708S adapter that supports the Remote PHY feature.

Chassis PHY Ethernet@Wirespeed

This property is the same as [Ethernet@Wirespeed](#), and is only available when the blade server is attached to a pass-through module.

Chassis PHY Flow Control

This property is the same as [Flow Control](#), and is only available when the blade server is attached to a pass-through module.

Chassis PHY Speed & Duplex

This property is the same as [Speed & Duplex](#) (excludes 1 Gb Full Auto), and is only available when the blade server is attached to a pass-through module.

Chassis SW Flow Control

This property is the same as [Flow Control](#), and is only available when the blade server is attached to a switch module.

Chassis SW Speed & Duplex

This property is the same as [Speed & Duplex](#) (SerDes), and is only available when the blade server is attached to a switch module.

Configuring System Settings

System Management on the **Configurations** tab allow you to view and change the values of the available properties for the system. The potentially available properties and their respective settings are described below.

Chimney Offload State

Enables TCP Offload Engine (TOE) for the entire system. On Windows Server 2008 operating systems, the options are Enable (default) and Disable. For Windows Server 2008 R2, the options are Enable, Disable, and Auto (default). If Chimney Offload State is configured for Auto, then a 10 Gbps network adapter will have TOE enabled, but not for a 1 Gbps network adapter.

To enable TOE for individual network adapters, configure Chimney Offload State to Enable and also enable TCP Connection Offload (IPv4) or TCP Connection Offload (IPv6) from the Advanced area of the Configuration tab.

Viewing Statistics

The information provided on the Statistics tab allows you to view traffic statistics for both Broadcom network adapters and network adapters made by others. Statistical information and coverage are more comprehensive for Broadcom adapters.

To view Statistics information for any installed network adapter, click the name of the adapter listed in the Explorer View pane, then click the Statistics tab.

If any of the sections described below is not visible, then from the **Context View** tab on the right side of the window, select **Statistics** and then select the name of the missing section.

Click **Refresh** to get the most recent values for each statistic. Click **Reset** to change all values to zero for the current BACS session.

NOTES:

- Team statistics are not compiled for a Broadcom network adapter if it is disabled.
- Some statistics may not be available for all Broadcom network adapters.

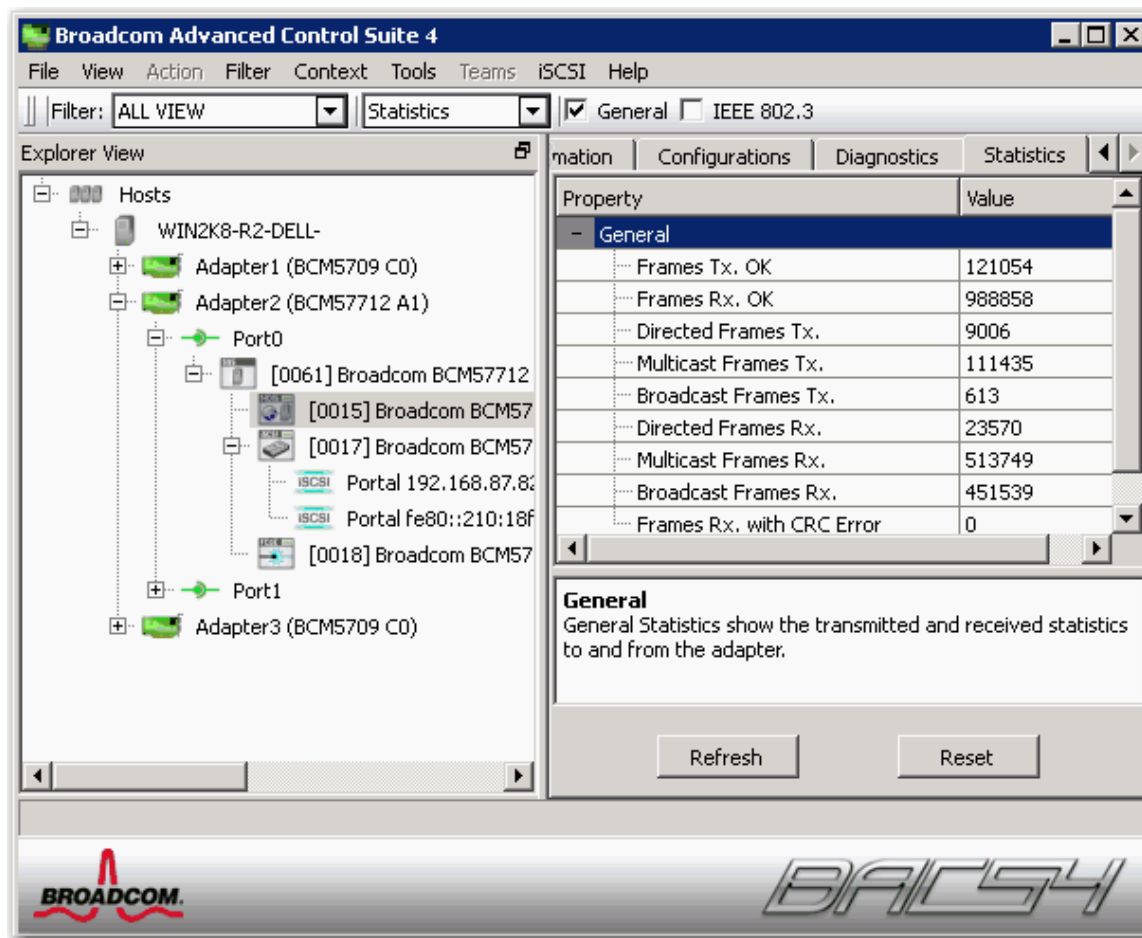

General Statistics

General Statistics show the transmitted and received statistics to and from the adapter.

Frames Tx OK

A count of the frames that were successfully transmitted. This counter is incremented when the transmit status is reported as Transmit OK.

Frames Rx OK

A count of the frames that were successfully received. This does not include frames received with frame-too-long, frame check sequence (FCS), length, or alignment errors, nor frames lost due to internal MAC sublayer errors. This counter is incremented when the receive status is reported as Receive OK.

Directed Frames Tx

A count of directed data frames that were successfully transmitted.

Multicast Frames Tx

A count of frames that were successfully transmitted (as indicated by the status value Transmit OK) to a group destination address other than a broadcast address.

Broadcast Frames Tx

A count of frames that were successfully transmitted (as indicated by the transmit status Transmit OK) to the broadcast address. Frames transmitted to multicast addresses are not broadcast frames and are excluded.

Directed Frames Rx

A count of directed data frames that were successfully received.

Multicast Frames Rx

A count of frames that were successfully received and are directed to an active nonbroadcast group address. This does not include frames received with frame-too-long, FCS, length, or alignment errors, nor frames lost because of internal MAC sublayer errors. This counter is incremented as indicated by the Receive OK status.

Broadcast Frames Rx

A count of frames that were successfully received and are directed to a broadcast group address. This count does not include frames received with frame-too-long, FCS, length, or alignment errors, nor frames lost because of internal MAC sublayer errors. This counter is incremented as indicated by the Receive OK status.

Frames Rx with CRC Error

The number of frames received with CRC errors.

Initiator Login Statistics

iSCSI login enables a connection for iSCSI use between the initiator and the target and is used to authenticate parties, negotiate the session's parameters, open security association protocol, and mark the connection as belonging to an iSCSI session.

Login Accept Responses

The number of login requests accepted by the target.

Login other failed Responses

The number of login requests that were not accepted by the target.

Login Redirect Responses

The number of responses that required further action by the initiator.

Login Authentication Failed Responses

The number of login requests that failed due to party authentication failure.

Login target authentication failure

The number of instances where the login could not authenticate the target.

Login target negotiation failure

The number of instances where the login could not negotiate the sessions parameters.

Normal logout command PDU

The number of normal logout commands issued by the initiator to remove a connection from a session or to close a session.

Other logout command PDU

The number of logout commands issued by the initiator for reasons other than to remove a connection from a session or to close a session.

Local Initiator login failures

The number of login failures likely caused by the initiator.

Initiator Instance Statistics

The statistics in this area pertain to all sessions.

Session digest errors

The number of sessions with errors due to an invalid payload or header.

Session connection timeout error

The number of sessions that were terminated due to any of the many timeout errors.

Session format error

The number of sessions with errors due to inconsistent fields, reserved fields not 0, non-existent LUN, etc.

Sessions failed

The number of failed sessions.

Custom

Custom statistics.

Total Offload iSCSI Connections

The total number of offloaded iSCSI connections.

Session Statistics

The statistics in this area only pertain to the named session.

Session Name

The name used for the session between the initiator and the target.

Session Id

The identifier used for the session between the initiator and the target.

Bytes sent

The number of bytes sent for the named session.

Bytes received

The number of bytes received for the named session.

PDU sent

The number of iSCSI PDUs sent for the named session.

PDU received

The number of iSCSI PDUs received for the named session.

Digest errors

The number of errors due to an invalid payload or header for the named session.

Connection Timeout errors

The number of connection timeout errors for the named session.

Format errors

The number of errors due to inconsistent fields, reserved fields not 0, non-existent LUN, etc. for the named session.

IEEE 802.3 Statistics

Frames Rx with Alignment Error

A count of the frames that were not an integral number of octets in length and do not pass the FCS check. This counter is incremented when the receive status is reported as Alignment Error.

Frames Tx with one Collision

A count of the frames that were involved in a single collision and were subsequently transmitted successfully. This counter is incremented when the result of a transmission is reported as Transmit OK, and the attempt value is 2.

Frames Tx with more than one Collision

A count of the frames that were involved in more than one collision and were subsequently transmitted successfully. This counter is incremented when the transmit status is reported as Transmit OK, and the value of the attempts variable is greater than 2 and less than or equal to the attempt limit.

Frames Tx after Deferral

A count of the frames that were delayed being transmitted on the first attempt because the medium was busy. The frames involved in any collision are not counted.

Custom Statistics

 NOTE: Custom statistics are available only for an enabled Broadcom network adapter.

Out of Recv. Buffer

The number of times the adapter ran out of Receive Buffer Descriptors. This information is only available for Broadcom NetXtreme II adapters.

Frames size less than 64-byte with bad FCS

The number of frames with a size less than 64 bytes with bad FCS.

MAC Rx w/ Pause Command and Length = 0

MAC control frames with the pause command and a length equal to 0.

MAC Rx w/ Pause Command and Length greater than 0

MAC control frames with the pause command and a length greater than 0.

MAC Rx w/ no Pause Command

MAC control frames with no pause command.

MAC Sent X-on

MAC Transmit with X-on was on.

MAC Sent X-off

MAC Transmit with X-on was off.

Large Send Offload Transmit Requests

The number of times the adapter was requested to transmit a packet performing TCP segmentation.

Total Offload TCP Connections

The total number of offloaded TCP connections.

SR-IOV Switch Statistics

This area shows the statistics for SR-IOV switches.

Num of Active VFs

This shows the number of active Virtual Functions (VF).

Viewing and Configuring Resource Reservations

 NOTES:

- Resource Reservation information is only available for Broadcom NetXtreme II adapters and VBD drivers.
- Not all offload technologies are available with all adapters.
- Resource Reservation information is not available in BACS on Linux systems.

The Resource Reservations section shows the number of connections allocated to an offload technology: TOE and iSCSI.

- TCP Offload Engine (TOE) for accelerating TCP over 1 GbE and 10 GbE.
- Internet Small Computer Systems Interface (iSCSI) offload for accelerating network storage access featuring centralized boot functionality (iSCSI boot).

You can also view the number of unlicensed resources and unallocated resources.

TOE and iSCSI can only be configured on certain adapters and require a license key. License keys are installed on the motherboard for use with LOMs and are preprogrammed in add-in NICs. TOE is a technology best suited for long-term TCP connections. TOE used in conjunction with applications that primarily deal with short-term connections may see suboptimal performance when compared to not using TOE. A short-term connection is a TCP connection that is established for only a few seconds at most, often less than one second. The overhead of establishing and tearing down the TCP connection with short-term connections may diminish the benefit that TOE provides. An example of an application that uses short-term connections is a web server that is not behind a load balancer. TCP connections for HTTP sessions are very short-lived and last only long enough to serve up a web page, after which the TCP connection is terminated. On the other hand, the same web server behind a load balancer benefits greatly from TOE since the TCP connections are long-lived between the web server and the load balancer. In contrast, a backup application is very likely to benefit from TOE since backup applications establish long-term connections between the server and the client.

To view resource reservations

1. Click the name of the Broadcom NetXtreme II system device in the Explorer View pane.
2. From the **Resource Reservations** section, select the property you want to set.
3. Click **Apply** to confirm the changes to all properties. Click **Reset** to return the properties to their original values.

To configure resource reservations

1. Select **Reserved Resources** for the Offload Configuration setting. Reservations allocate the minimum number of connections per technology. See [Table 1](#) for the maximum number of connections available for various configurations.
2. Click **First Come First Served** to allow connections on a first-come-first-served basis to any enabled offload technology (TOE or iSCSI) as long as resources are available. Otherwise, click **Reserved Resources** to set the maximum number of connections for each offload technology. This option is not available for 10 Gbps network adapters.
3. If allocating TOE connections, select the **TCP Offload Engine (TOE)** check box and slide the bar or enter a number in the value box. This is the maximum number of connections available for TOE offload.
4. If allocating iSCSI connections, select the **iSCSI** check box and slide the bar or enter a number in the value box. This is the maximum number of connections available for iSCSI offload.
5. After the configurations are complete, click **Apply** to save the settings or click **Reset** to revert back to the previous settings. A chart of the resource allocations appears below the resource configurations.
6. If prompted, reboot the system.

Table 1: Maximum Number of Offload Connections

Offload	First Come First Served	Reserved Resources	Maximum Number of Connections
TOE only	Selected	–	1024
TOE only	–	Selected	864
iSCSI only	Selected	–	Between 7 and 100
iSCSI only	–	Selected	28

Configuring the IP Address for iSCSI Offload

For iSCSI-booted adapters, the Configurations tab is not available and you will not be able to perform this procedure.

To set the IP address of the iSCSI HBA for iSCSI offload

The **iSCSI Management** section of the **Configurations** tab allows you to set the IP address of the iSCSI HBA when using iSCSI protocol to offload network processing from the CPU to the Broadcom network adapter.

1. Click the name of the Broadcom NetXtreme II iSCSI device in the SCSI controller section of the Explorer View pane.
2. Depending on the protocol you will be using, for **IPv4 DHCP** or **IPv6 DHCP**, select **Enable** (not available for iSCSI booted adapters) to set the IP address dynamically using a DHCP server. Or select **Disable** to set the IP address using a static IP address. Enter the **IP Address**, **Subnet Mask**, and **Default Gateway**.
3. Configure the VLAN ID for the iSCSI HBA by entering a number for **VLAN ID**. The value must be between 1 and 4094.
4. After the configurations are complete, click **Apply** to save the settings or click **Reset** to revert back to the previous settings.

Viewing Licenses

 NOTES:

- The **Licenses** section of the **Configurations** tab is only available for Broadcom NetXtreme II adapters and VBD drivers.
- Not all offload technologies are available with all adapters.

The **Licenses** section shows the number of connections available for TOE and iSCSI offload technologies.

To view licenses

1. Click the name of the Broadcom NetXtreme II system device in the Explorer View pane.

Configuring Teaming

 NOTE: BACS does not support teaming on Linux systems. Linux provides a similar built-in functionality called Channel Bonding. Refer to the Linux OS documentation for more information.

The teaming function allows you to group any available network adapters together to function as a team. Teaming is a method of creating a virtual NIC (a group of multiple adapters that functions as a single adapter). The benefit of this approach is that it enables load balancing and failover. Teaming is done through the Broadcom Advanced Server Program (BASP) software. For a comprehensive description of the technology and implementation considerations of the teaming software, refer to the "Broadcom Gigabit Ethernet Teaming Services" section of your Broadcom network adapter user guide.

Teaming can be accomplished by either of the following methods:

- [Using the Broadcom Teaming Wizard](#)
- [Using Expert Mode](#)

 NOTES:

- For further information regarding teaming protocols, see "Teaming" in your Broadcom network adapter user guide.
- If you do not enable LiveLink™ when configuring teams, disabling Spanning Tree Protocol (STP) at the switch is recommended. This minimizes the downtime due to spanning tree loop determination when failing over. LiveLink mitigates such issues.
- BASP is available only if a system has one or more Broadcom network adapters installed.
- The TCP Offload Engine (TOE), Large Send Offload (LSO), and Checksum Offload properties are enabled for a team only when all of the members support and are configured for the feature.
- To physically remove a teamed NIC from a system, you must first delete the NIC from the team. Not doing this before shutting down the system could result in breaking the team on a subsequent reboot, which may result in unexpected team behavior.
- If an adapter is included as a member of a team and you change any advanced property, then you must rebuild the team to ensure that the team's advanced properties are properly set.
- If an adapter with a TOE key is included as a member of a team and you remove the TOE key, then you must rebuild the team to ensure that the team does not appear as a TOE-enabled team.
- You must have administrator privileges to create or modify a team.
- The load balance algorithm in a team environment in which members are connected at different speeds favors members connected with a Gigabit Ethernet link over members connected at lower speed links (100 Mbps or 10 Mbps) until a threshold is met. This is normal behavior.
- In a GEC or 802.3ad type team, disabling the device driver(s) of a team member that has IPMI enabled may prevent a successful failover since IPMI maintains link with the attached switch.
- Do not assign a Locally Administered Address on any physical adapter that is a member of a team.

Team Types

You can create four types of load balance teams:

- Smart Load Balance and Failover
- Link Aggregation (802.3ad) (TOE is not applicable)
- Generic Trunking (FEC/GEC)/802.3ad-Draft Static (TOE is not applicable)
- SLB (Auto-Fallback Disable) – The Auto-Fallback Disable feature is configured for Smart Load Balance and Failover type teams in the Teaming Wizard.

 NOTE: NetXtreme II network adapters with iSCSI enabled is supported only in an SLB team type.

Smart Load Balance and Failover

In this type of team, a standby member handles the traffic if all of the load balance members fail (a failover event). All load balance members have to fail before the standby member takes over. When one or more of the load balance members is restored (fallback), the restored team member(s) resumes the handling of the traffic. The LiveLink feature is supported for this type of team.

Link Aggregation (802.3ad)

In this type of team, you can dynamically configure the network adapters that have been selected to participate in a given team. If the link partner is not correctly configured for IEEE 802.3ad link configuration, errors are detected and noted. All adapters in the team are configured to receive packets for the same MAC address. The outbound load balancing scheme is determined by the BASP driver. The link partner of the team determines the load balancing scheme for inbound packets. In this mode, at least one of the link partners must be in active mode.

 **NOTE:** TOE is not applicable for Link Aggregation team type. NetXtreme II network adapters with iSCSI enabled is not supported for Link Aggregation team type.

Generic Trunking (FEC/GEC)/802.3ad-Draft Static

This type of team is very similar to the link aggregation type, in that all adapters in the team must be configured to receive packets for the same MAC address. This mode does not provide link aggregation control protocol (LACP) or marker protocol support. This mode supports a variety of environments where the link partners are statically configured to support a proprietary trunking mechanism. Trunking supports load balancing and failover for both outbound and inbound traffic.

 **NOTE:** TOE is not applicable for Generic Trunking (FEC/GEC)/802.3ad-Draft Static team type. NetXtreme II network adapters with iSCSI enabled is not supported for Generic Trunking (FEC/GEC)/802.3ad-Draft Static team type.

SLB (Auto-Fallback Disable)

This team is identical to Smart Load Balance and Failover, with the following exception: when the standby member is active, if a primary member comes back online, the team continues using the standby member rather than switching back to the primary member. This type of team is supported only for situations in which the network cable is disconnected and reconnected to the network adapter. It is not supported for situations in which the adapter is removed/installed through Device Manager or Hot-Plug PCI. If any primary adapter assigned to a team is disabled, the team functions as a Smart Load Balancing and Failover type of team in which auto-fallback occurs. The LiveLink feature is supported for this type of team.

Standby Team Member and Auto-Fallback Disable Mode

You can designate one team member in an SLB type of team to be the standby member. The standby member does not actively send and receive normal network traffic while other adapters on the team are active. If all of the active adapters on the team fail or are disconnected, the standby member takes over the handling of the network activities.

In Auto-Fallback Disable mode, if a load balance member returns on line, the team continues using the standby member rather than switching back to using the load balance member. Consequently, the adapter that was initially designated a load balance member remains in an inactive state and becomes the new standby member.

LiveLink

LiveLink is a feature of BASP that is available for the Smart Load Balancing (SLB) and SLB (Auto-Fallback Disable) type of teaming. The purpose of LiveLink is to detect link loss beyond the switch and to route traffic only through team members that have a live link.

Using the Broadcom Teaming Wizard

You can use the Broadcom Teaming Wizard to create a team, configure an existing team if a team has already been created, or create a VLAN.

1. Create or edit a team:

To create a new team, select **Create a Team** from the **Team** menu, or right-click one of the devices in the "Unassigned Adapters" section and select **Create a Team**. This option is not available if there are no devices listed in the "Unassigned Adapters" sections, which means all adapters are already assigned to teams.

To configure an existing team, right-click one of the teams in the list and select **Edit Team**. This option is only available if a team has already been created and is listed in the Team Management pane.

 **NOTE:** If you prefer to work without the wizard for now, click **Expert Mode**. If you want to always use Expert Mode to create a team, select **Default to Expert Mode on next start**. See [Using Expert Mode](#).

2. To continue using the wizard, click **Next**.

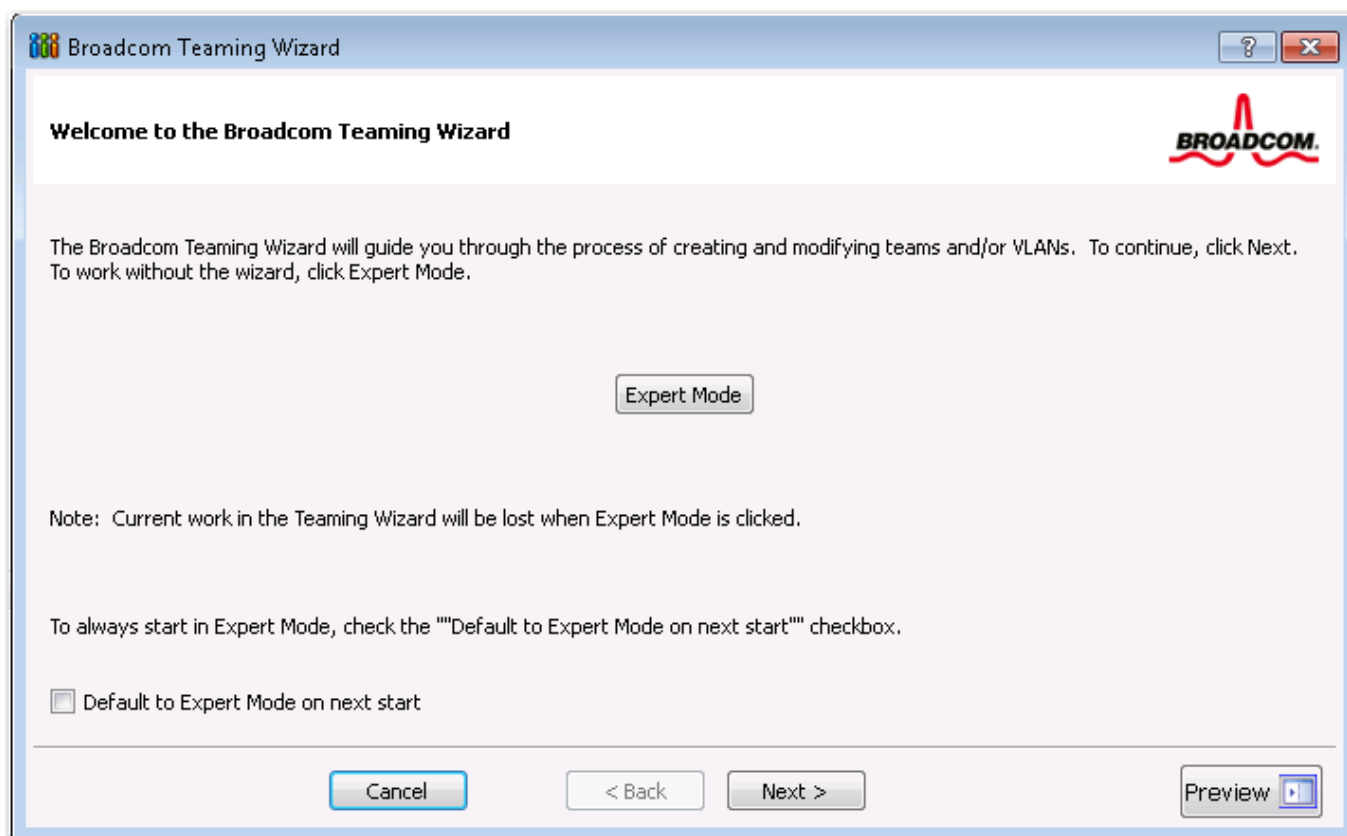

3. Type the team name and then click **Next**. If you want to review or change any of your settings, click **Back**. Click **Cancel** to discard your settings and exit the wizard.

 **NOTE:** The team name cannot exceed 39 characters, cannot begin with spaces, and cannot contain any of the following characters: & \ / : * ? < > |

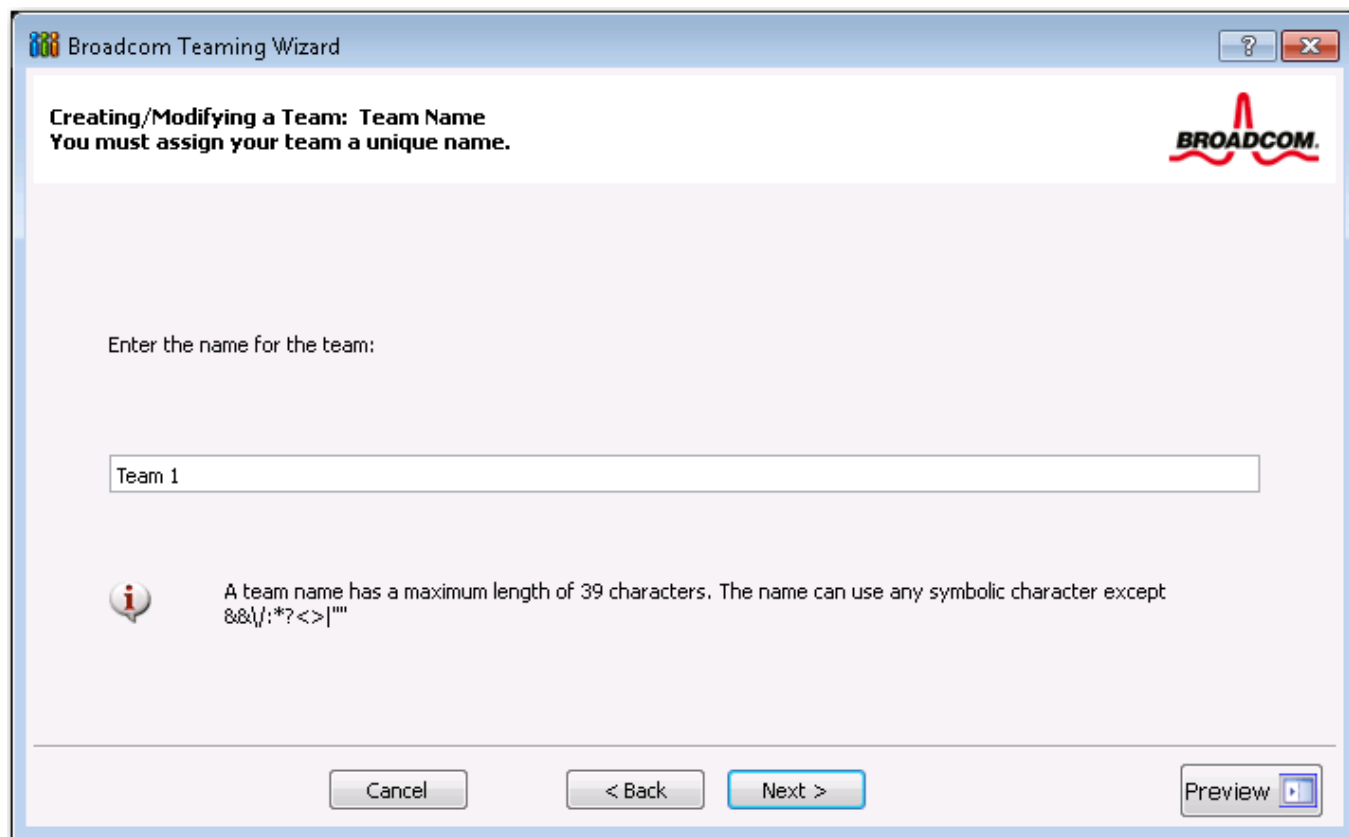

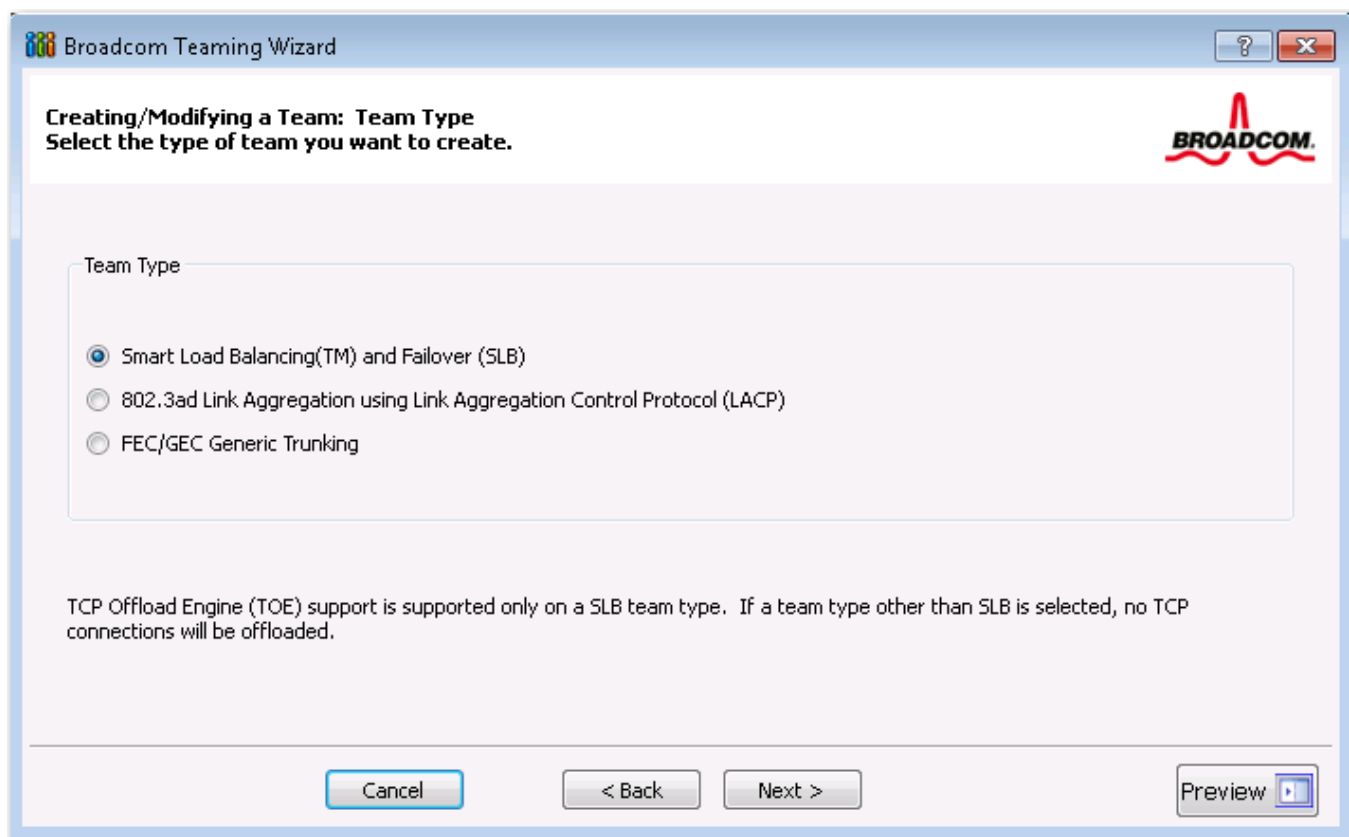

4. Select the type of team you want to create.
5. Select **Enable Hyper-V Mode** if you want to enable Windows virtualization services. See "Microsoft Virtualization with Hyper-V" in the Troubleshooting topic in the *NetXtreme II Network Adapter User Guide* for more information about this feature.
6. If the team type is an SLB type team, click **Next**. If the team type is not an SLB type team, then a dialog box appears. Verify that the network switch connected to the team members is configured correctly for the team type, click **OK**, and continue.

 **NOTE:** NetXtreme II network adapters with iSCSI enabled is supported only in an SLB team type. To continue with the creation of non-SLB team types, first disable iSCSI by deselecting **iSCSI Offload Engine** from the **Resource Reservations** area of the Configurations tab.



7. From the **Available Adapters** list, click the adapter you want to add to the team and then click **Add**. Remove team members from the **Team Members** list by clicking the adapter and then clicking **Remove**. Click **Next**.

 **NOTE:** There must be at least one Broadcom network adapter assigned to the team.

 **NOTE:** A team created with a single adapter will not have load balancing or failover capabilities.

The TCP Offload Engine (TOE), Large Send Offload (LSO) and Checksum Offload (CO) columns indicate if the TOE, LSO, Jumbo MTU, and/or the CO properties are supported for the adapter. The TOE, LSO, Jumbo MTU, and CO properties are enabled for a team only when all of the members support and are configured for the feature. If this is the case, then the team offload capabilities appear on the bottom of the screen.

 **NOTES:**

- If an adapter is included as a member of a team and you change any advanced property, then you must rebuild the team to ensure that the team's advanced properties are properly set.
- If an adapter with a TOE key is included as a member of a team and you remove the TOE key, then you must rebuild the team to ensure that the team does not appear as a TOE-enabled team.
- Adding a network adapter to a team where its driver is disabled may negatively affect the offloading capabilities of the team. This may have an impact on the team's performance. Therefore, it is recommended that only driver-enabled network adapters be added as members to a team.

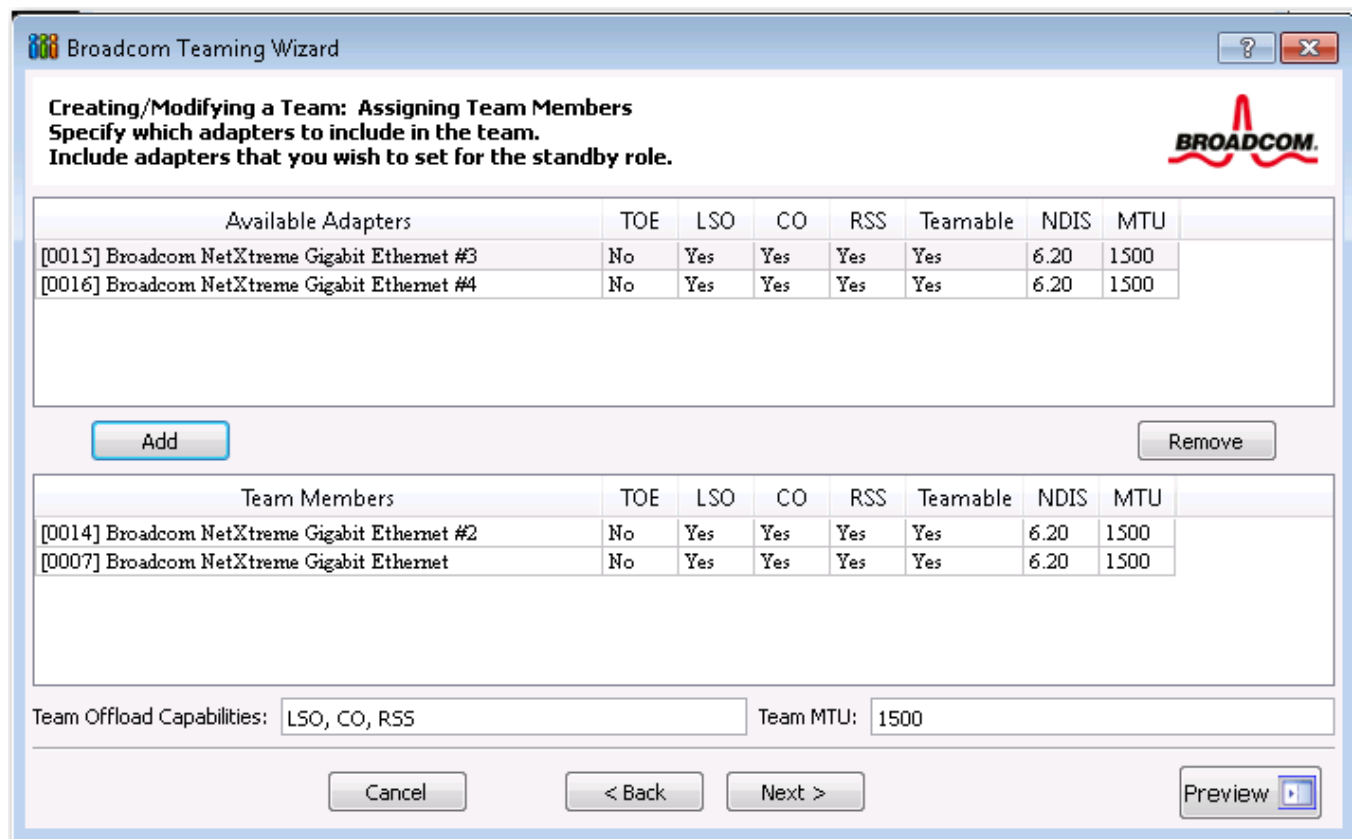

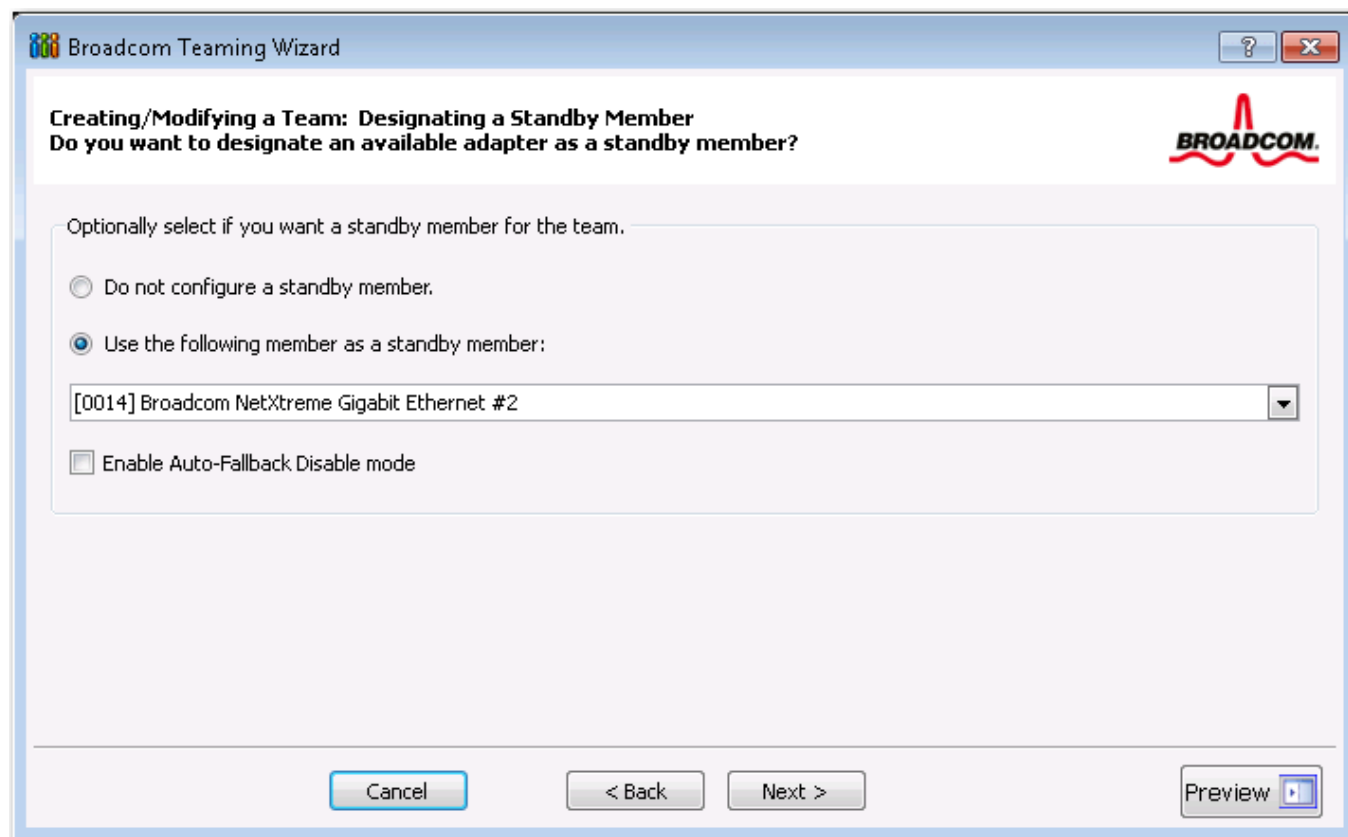

8. If you want to designate one of the adapters as a standby member (optional), select **Use the following member as a standby member**, then choose the standby member from the list of adapters.
9. The Auto-Fallback Disable mode feature allows the team to continue using the standby member rather than switching back to the primary member if the primary member comes back online. To enable this feature, select **Enable Auto-Fallback Disable mode**. Click **Next**.

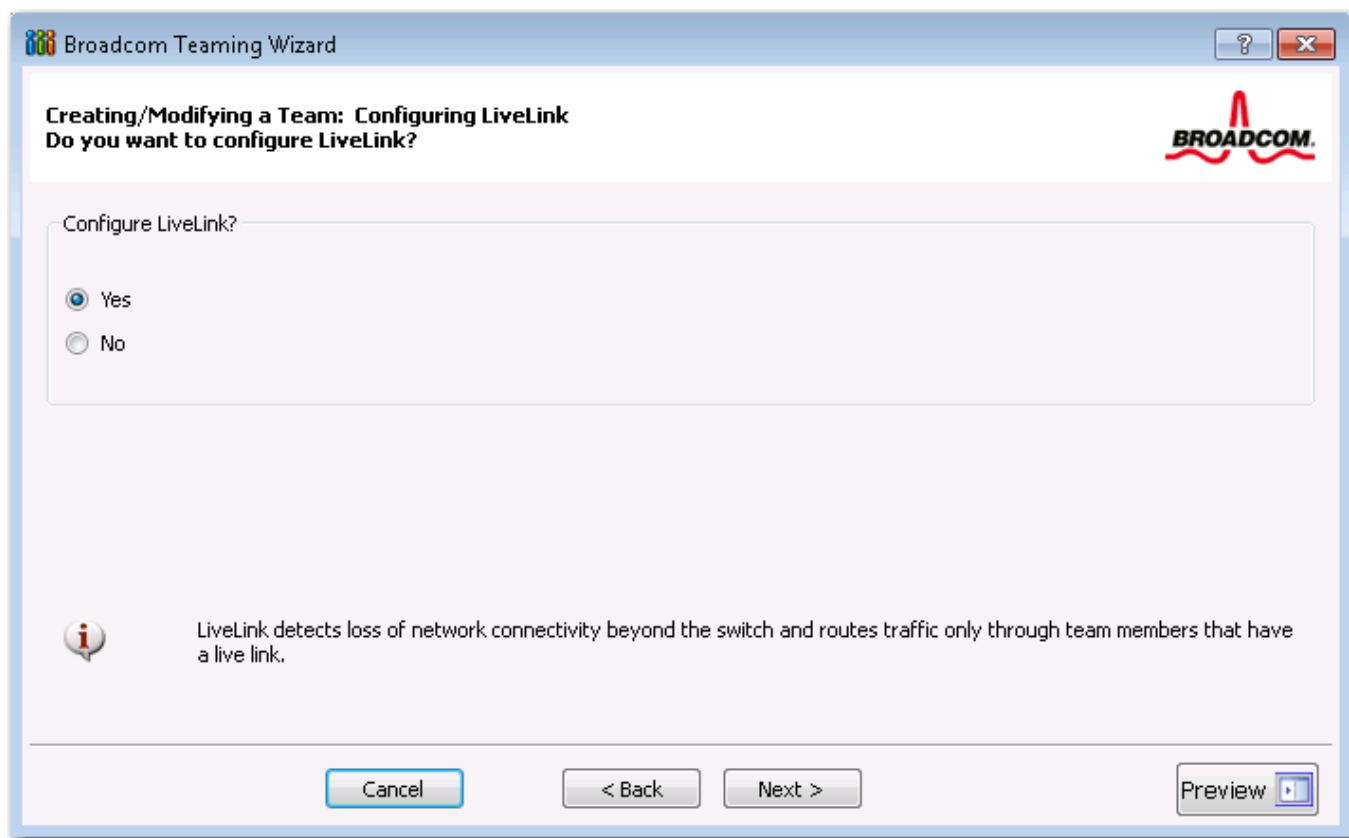

10. If you want to configure LiveLink, select **Yes**, otherwise select **No**, then click **Next**.



11. Select the probe interval (the number of seconds between each retransmission of a link packet to the probe target) and the maximum number of probe retries (the number of consecutively missed responses from a probe target before a failover is triggered).
12. Set the Probe VLAN ID to allow for connectivity with probe targets residing on a tagged VLAN. The number set must match the VLAN ID of the probe targets as well as the port(s) on the switch to which the team is connected.
-  **NOTE:** Each LiveLink enabled team can only communicate with Probe Targets on a single VLAN. Also, VLAN ID 0 is equivalent to an untagged network. If the Probe VLAN ID is set to a value other than 0, then a VLAN must be created with an identical VLAN tag value (see [Step 18.](#)).
13. Click the probe target at the top of the list, click **Edit Target IP Address**, type the target IP address in the **IP Address** box for one or all probe targets, and then click **OK**. Click **Next**.
-  **NOTE:** Only the first probe target is required. You can specify up to three additional probe targets to serve as backups by assigning IP addresses to the other probe targets.
14. Select a listed team member, click **Edit Member IP Address**, and then type the member IP address in the IP Address box. Repeat for all listed team members and then click **OK**. Click **Next**.
-  **NOTE:** All of the member IP addresses must be in the same subnet as the subnet of the probe targets.
15. If you want to create a VLAN on the team, select **Add VLAN**, or if you want to change the settings of an existing VLAN, select **Edit VLAN**, then click **Next**. If you do not want to create or edit a VLAN, select **Skip Manage VLAN**, then click **Next**, and continue with the wizard from the Finish screen (see [Step 20.](#) of this procedure).

VLANs enable you to add multiple virtual adapters that are on different subnets. The benefit of this is that your system can have one network adapter that can belong to multiple subnets.

 **NOTE:** VLANs can only be created when all team members are Broadcom adapters.

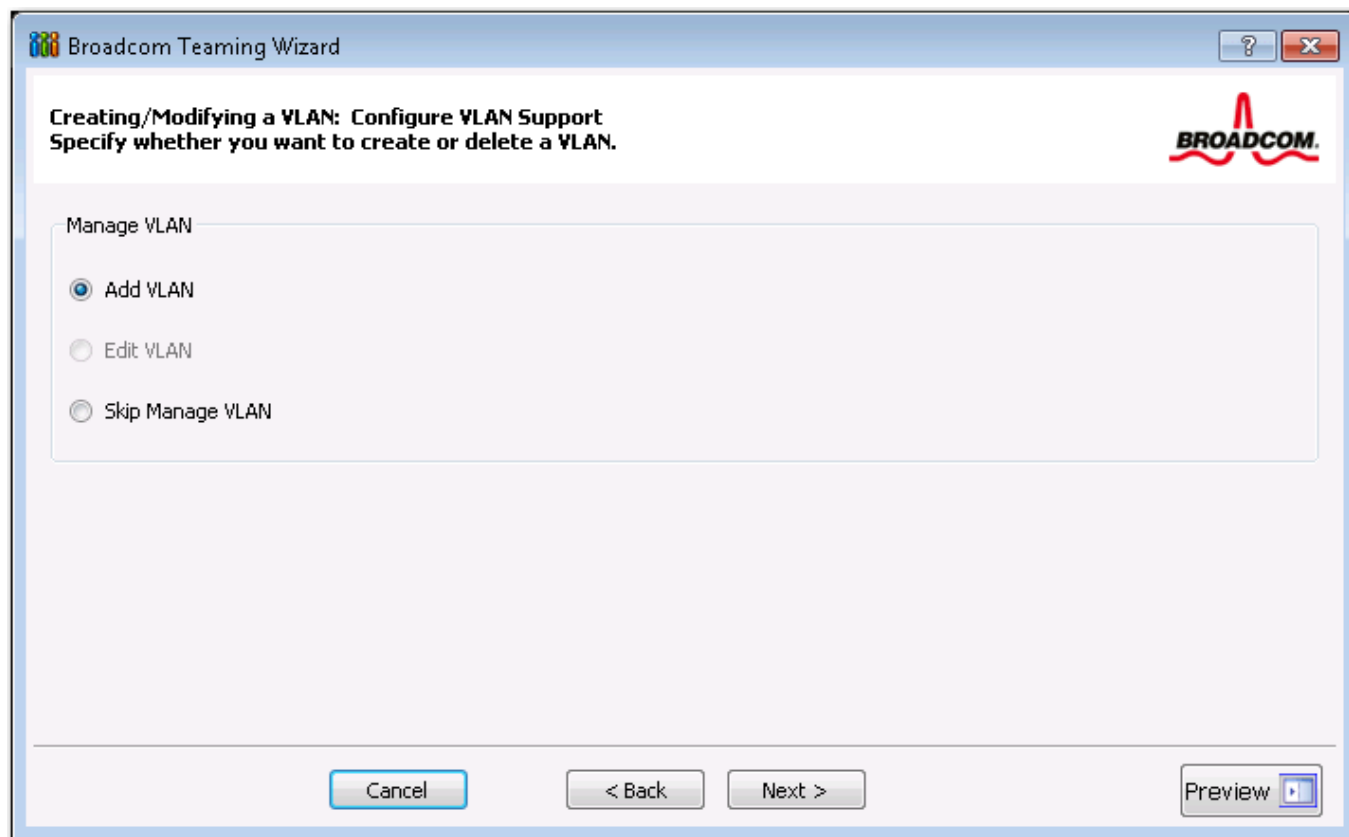

16. Type the VLAN name and then click **Next**.

 **NOTE:** The team name cannot exceed 39 characters, cannot begin with spaces, and cannot contain any of the following characters: & \ / : * ? < > |

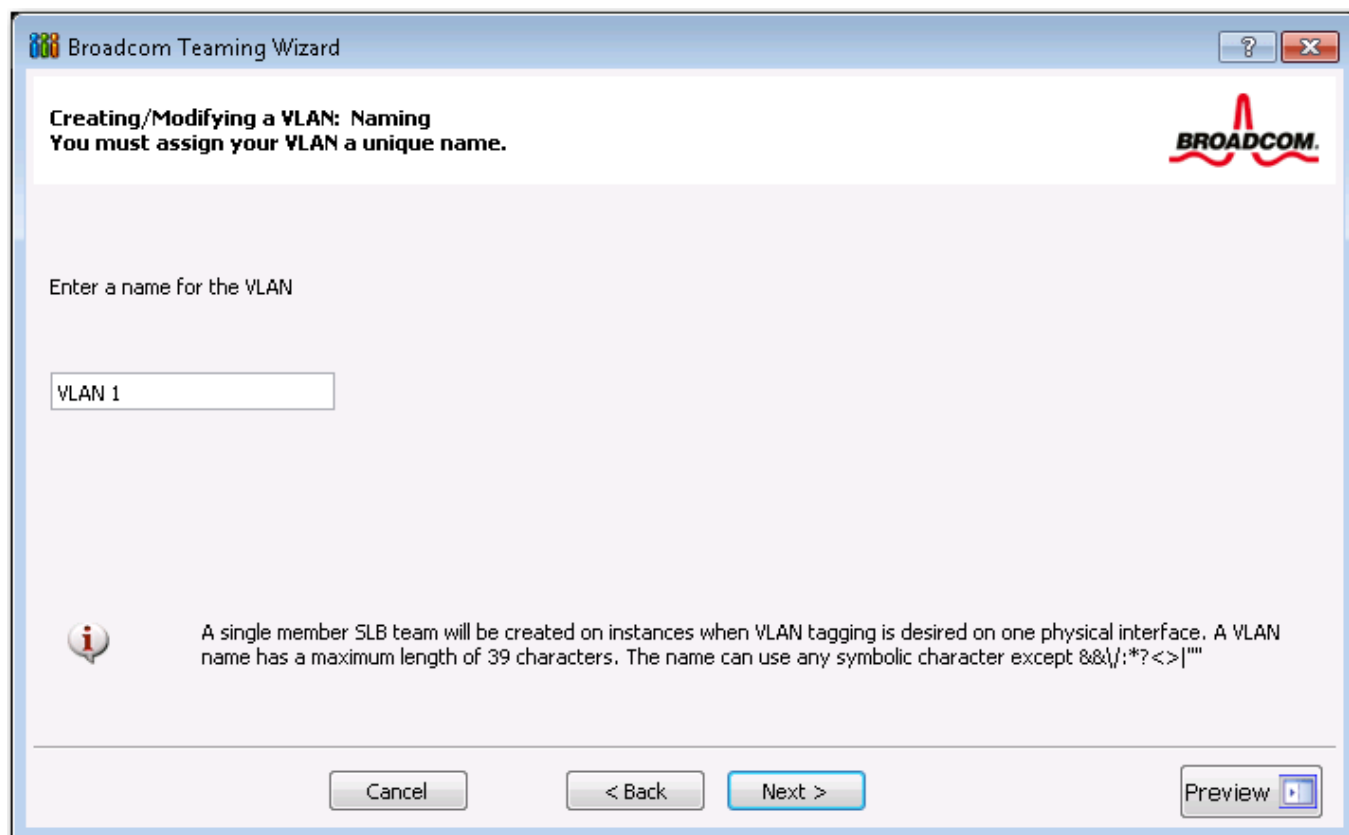

17. To tag the VLAN, select **Tagged** and then click **Next**. Otherwise, click **Untagged**, click **Next**, and continue with the wizard to

add additional VLANs (see [Step 19](#) of this procedure).

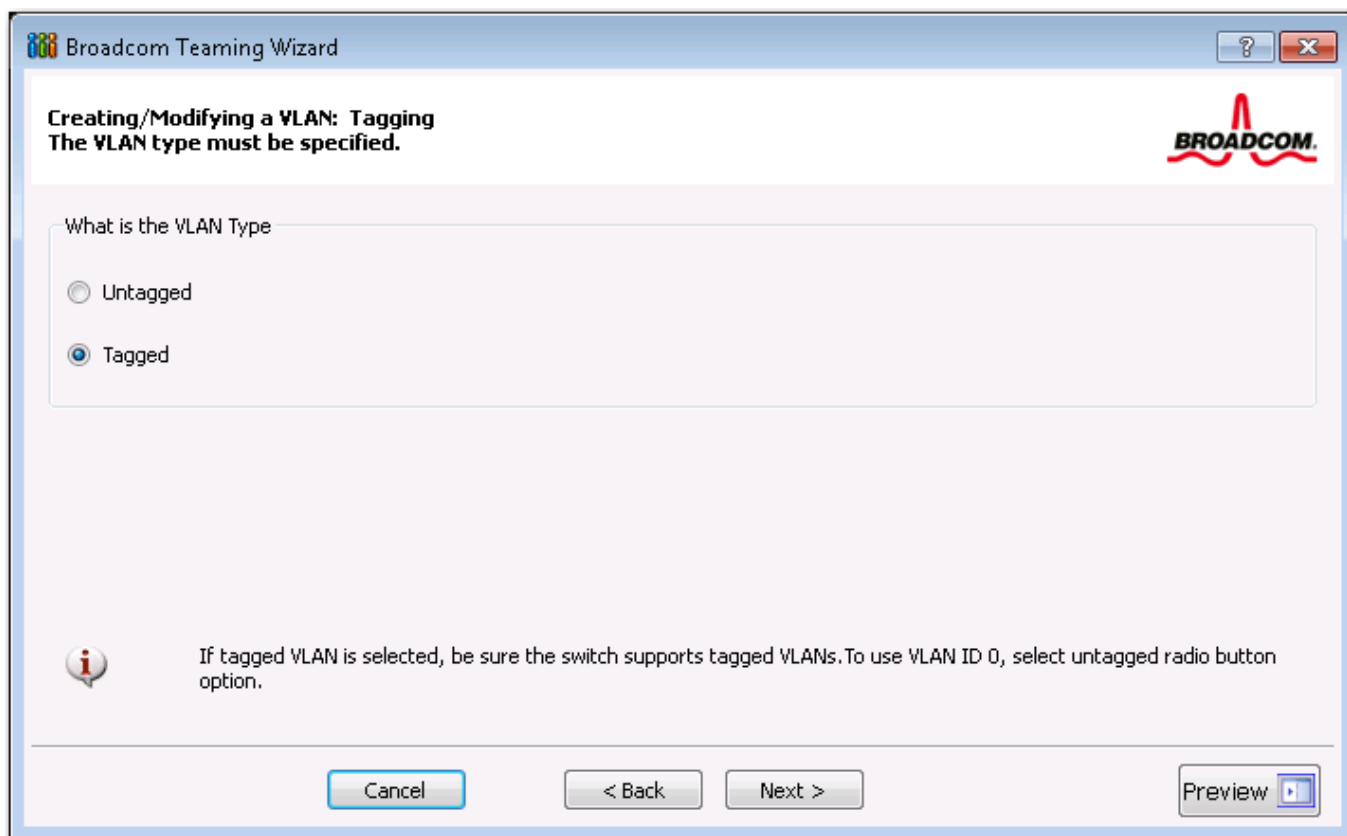

18. Type the VLAN tag value and then click **Next**. The value must be between 1 and 4094.

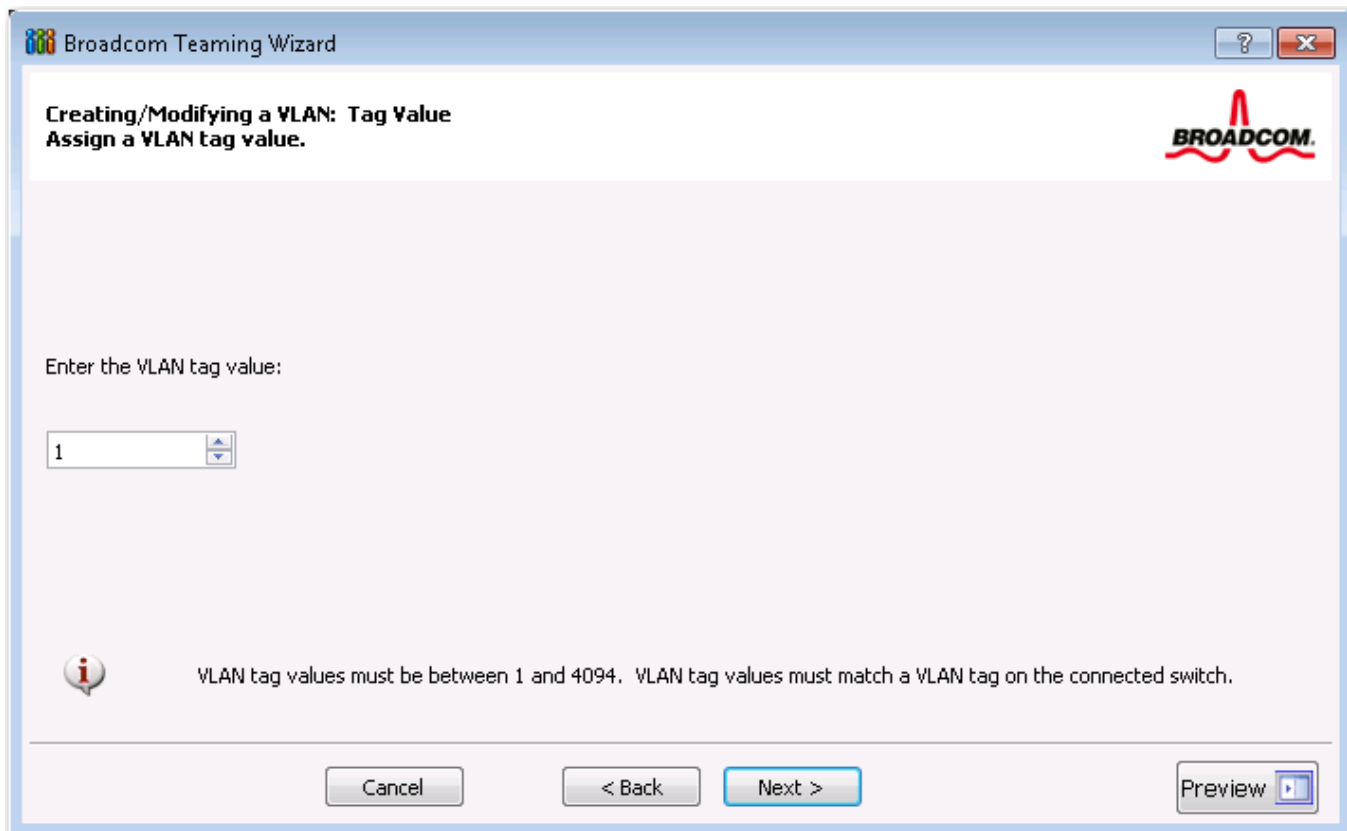

19. Select **Yes** to add or manage another VLAN and then click **Next**. Repeat until you do not want to add or manage any

additional VLANs.

 **NOTE:** You can define up to 64 VLANs per team (63 VLANs that are tagged and 1 VLAN that is not tagged). Adding several VLANs may slow down the reaction time of the Windows interface due to memory and processor time usage for each VLAN. The degree to which Windows performance may suffer depends on system configuration.

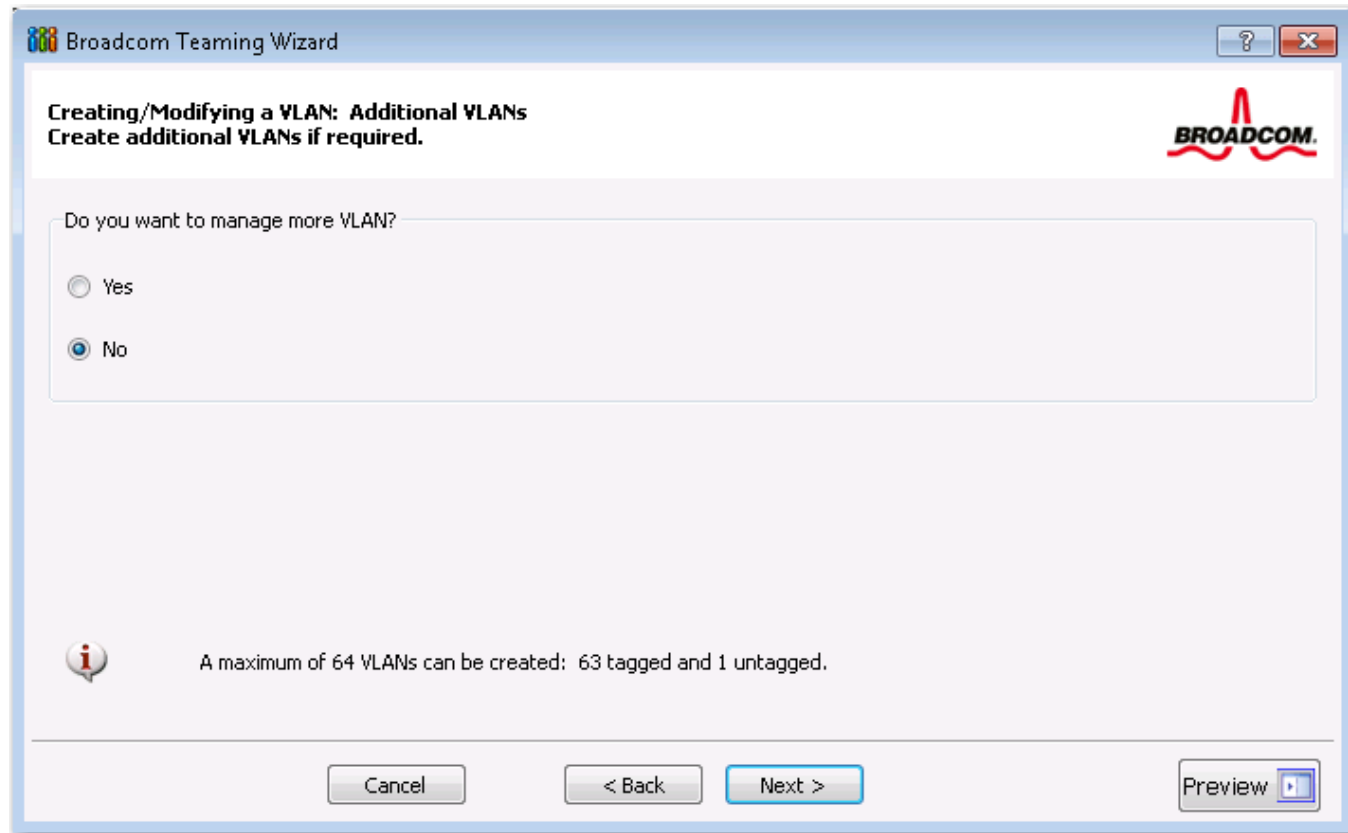

20. To apply and commit the changes to the team, select **Commit changes to system and Exit the wizard**. To apply your changes but continue using the wizard, select **Save changes and continue to manage more teams**. Click Finish.

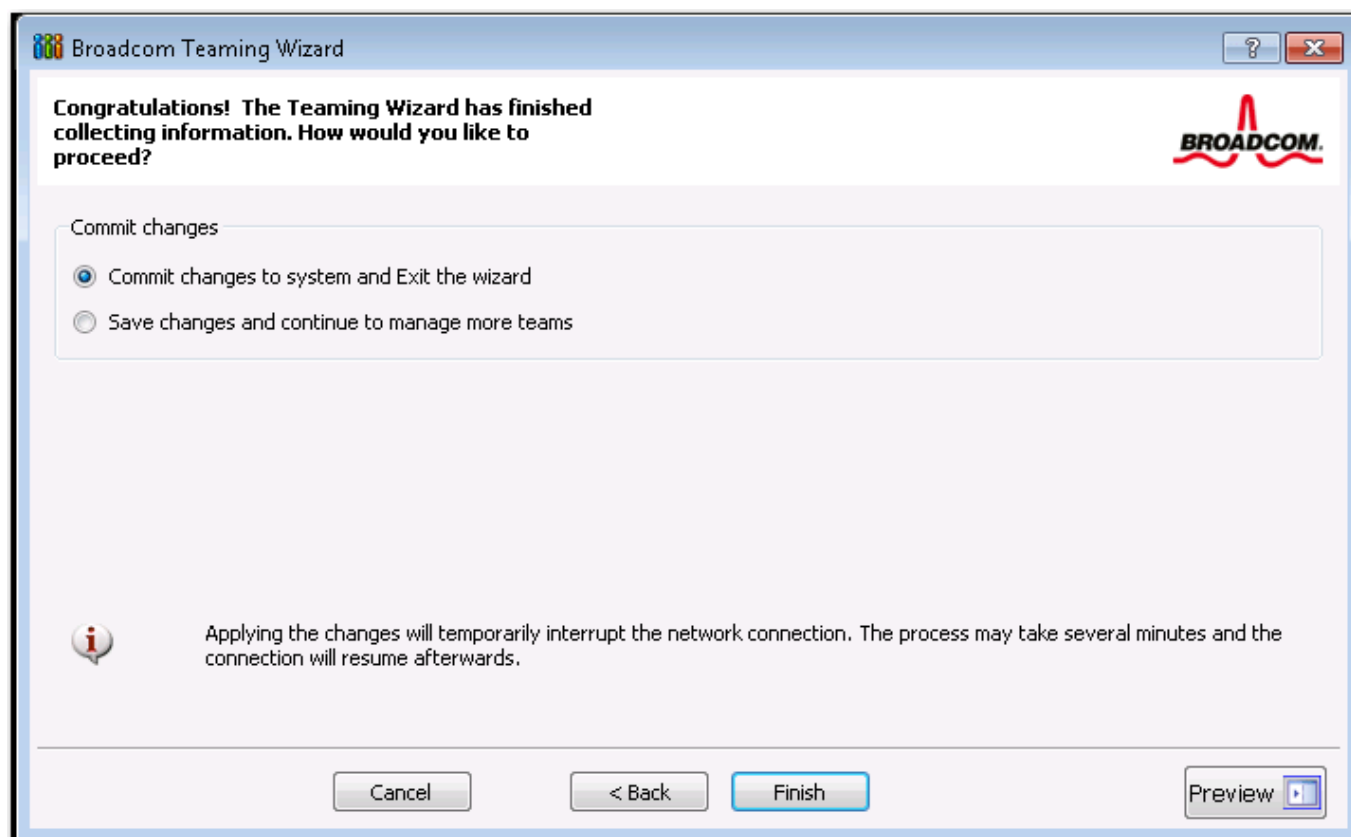

NOTE: At any point in the Broadcom Teaming Wizard procedure, click **Preview** to get a visual representation of what the team will look like before committing any changes.

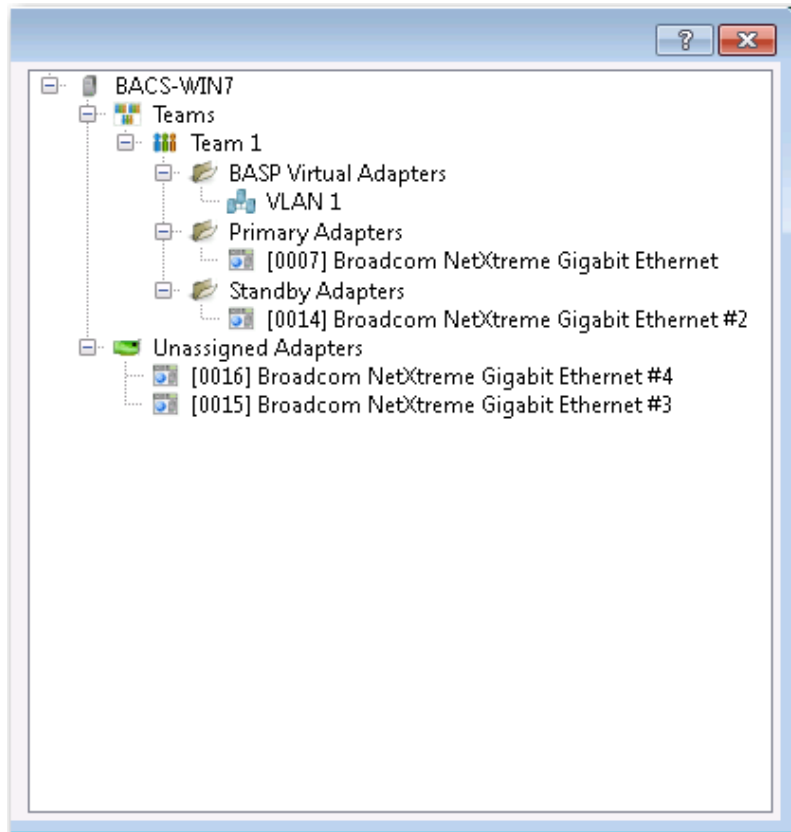

- Click the team name in the Team Management pane to view the team's properties in the **Information** tab, transfer and receive data in the **Statistics** tab, and team customization options in the **Configurations** tab.

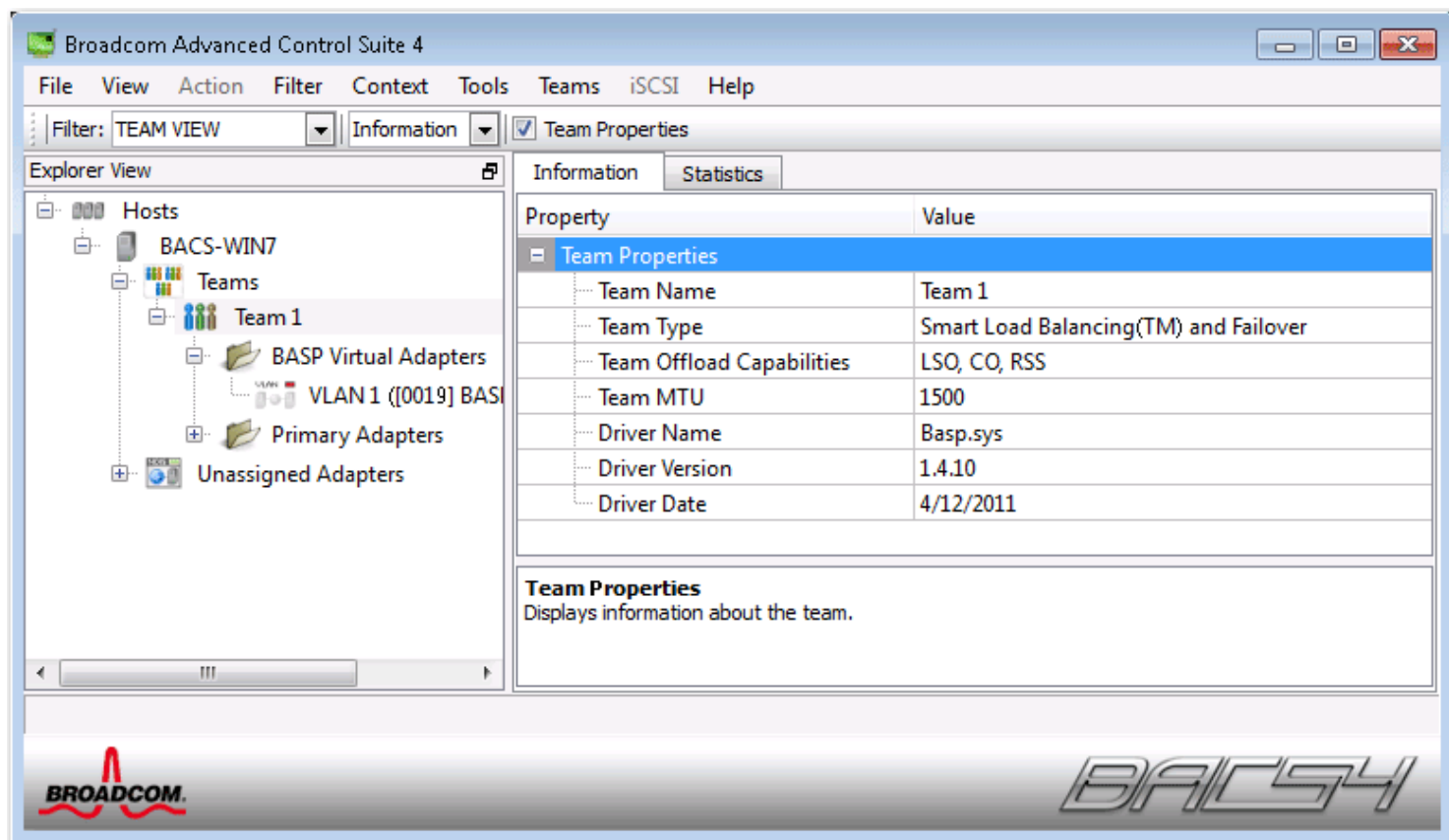

Using Expert Mode

Use Expert Mode to create a team, modify a team, add a VLAN, and configure LiveLink for a Smart Load Balance and Failover and SLB (Auto-Fallback Disable) team. To create a team using the wizard, see [Using the Broadcom Teaming Wizard](#).

To set the default Teaming Mode, select **Options** from the **Tools** menu. In the **Options** window, click the **General** tab, then select **Expert Mode** or **Wizard Mode** (the default is Wizard Mode).

Creating a Team

 **NOTE:** Enabling Dynamic Host Configuration Protocol (DHCP) is not recommended for members of an SLB type of team.

1. From the **Teams** menu, select **Create a Team**, or right-click one of the devices in the "Unassigned Adapters" section and select **Create a Team**. This option is not available if there are no devices listed in the "Unassigned Adapters" sections, which means all adapters are already assigned to teams.
2. Click **Expert Mode**.

 **NOTE:** If you want to always use Expert Mode to create a team, click **Default to Expert Mode on next start**.

3. Click the **Create Team** tab.

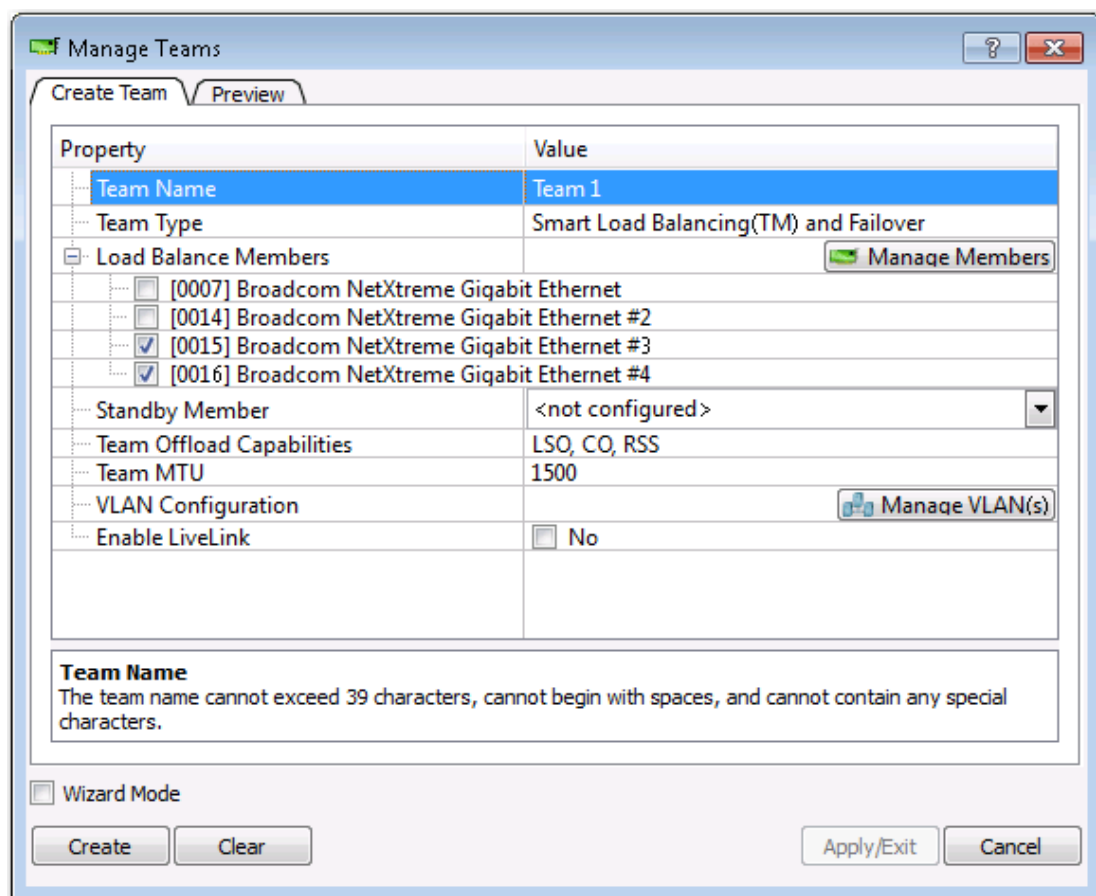

NOTE: The **Create Team** tab appears only if there are teamable adapters available.

- Click the **Team Name** field to enter a team name.
- Click the **Team Type** field to select a team type.
- Click **Hyper-V Mode** if you want to enable Windows virtualization services. See "Microsoft Virtualization with Hyper-V" in the "Troubleshooting" topic in the *NetXtreme II Network Adapter User Guide* for more information about this feature.
- Assign any available adapter or adapters to the team by moving the adapter from the **Available Adapters** list to the **Load Balance Members** list. There must be at least one adapter in the **Load Balance Members** list.
- You can assign any other available adapter to be a standby member by selecting it from the **Standby Member** list.

NOTE: There must be at least one Broadcom network adapter assigned to the team.

NOTE: A team created with a single adapter will not have load balancing or failover capabilities.

The TCP Offload Engine (TOE), Large Send Offload (LSO), and Checksum Offload (CO) columns indicate if the TOE, LSO, and/or the CO properties are supported for the adapter. The TOE, LSO, and CO properties are enabled for a team only when all of the members support and are configured for the feature. If this is the case, then the team offload capabilities appear on the bottom of the screen.

NOTES:

- If an adapter is included as a member of a team and you change any advanced property, then you must rebuild the team to ensure that the team's advanced properties are properly set.
 - If an adapter with a TOE key is included as a member of a team and you remove the TOE key, then you must rebuild the team to ensure that the team does not appear as a TOE-enabled team.
 - Adding a network adapter to a team where its driver is disabled may negatively affect the offloading capabilities of the team. This may have an impact on the team's performance. Therefore, it is recommended that only driver-enabled network adapters be added as members to a team.
- Type the value for **Team MTU**.
 - Click **Create** to save the team information.
 - Repeat steps 4. through 10. to define additional teams. As teams are defined, they can be selected from the team list, but they have not yet been created. Click the **Preview** tab to view the team structure before applying the changes.

12. Click **Apply/Exit** to create all the teams you have defined and exit the Manage Teams window.
13. Click **Yes** when the message is displayed indicating that the network connection will be temporarily interrupted.

 **NOTES:**

- o The team name cannot exceed 39 characters, cannot begin with spaces, and cannot contain any of the following characters: & \ / : * ? < > |
 - o Team names must be unique. If you attempt to use a team name more than once, an error message is displayed indicating that the name already exists.
 - o The maximum number of team members is 8.
 - o When team configuration has been correctly performed, a virtual team adapter driver is created for each configured team.
 - o If you disable a virtual team and later want to reenoble it, you must first disable and reenoble all team members before you reenoble the virtual team.
 - o When you create Generic Trunking and Link Aggregation teams, you cannot designate a standby member. Standby members work only with Smart Load Balancing and Failover and SLB (Auto-Fallback Disable) types of teams.
 - o For an SLB (Auto-Fallback Disable) team, to restore traffic to the load balance members from the standby member, click the Fallback button on the Team Properties tab.
 - o When configuring an SLB team, although connecting team members to a hub is supported for testing, it is recommended to connect team members to a switch.
 - o Not all network adapters made by others are supported or fully certified for teaming.
14. Configure the team IP address.
 - a. From **Control Panel**, double-click **Network Connections**.
 - b. Right-click the name of the team to be configured, and then click **Properties**.
 - c. On the **General** tab, click **Internet Protocol (TCP/IP)**, and then click **Properties**.
 - d. Configure the IP address and any other necessary TCP/IP configuration for the team, and then click **OK** when finished.

Modifying a Team

After you have created a team, you can modify the team in the following ways:

- Change the type of team
- Change the members assigned to the team
- Add a VLAN
- Modify a VLAN (using Expert Mode)
- Remove a team or a VLAN (using Expert Mode)

To modify a team

1. From the **Team** menu, click **Edit Team**, or right-click one of the teams in the list and select **Edit Team**. This option is only available if a team has already been created and is listed in the Team Management pane.
2. The wizard Welcome screen appears. Click **Next** to continue modifying a team using the wizard or click **Expert Mode** to work in Expert Mode.

 **NOTE:** The **Edit Team** tab in Expert Mode appears only if there are teams configured on the system.

3. Click the **Edit Team** tab.

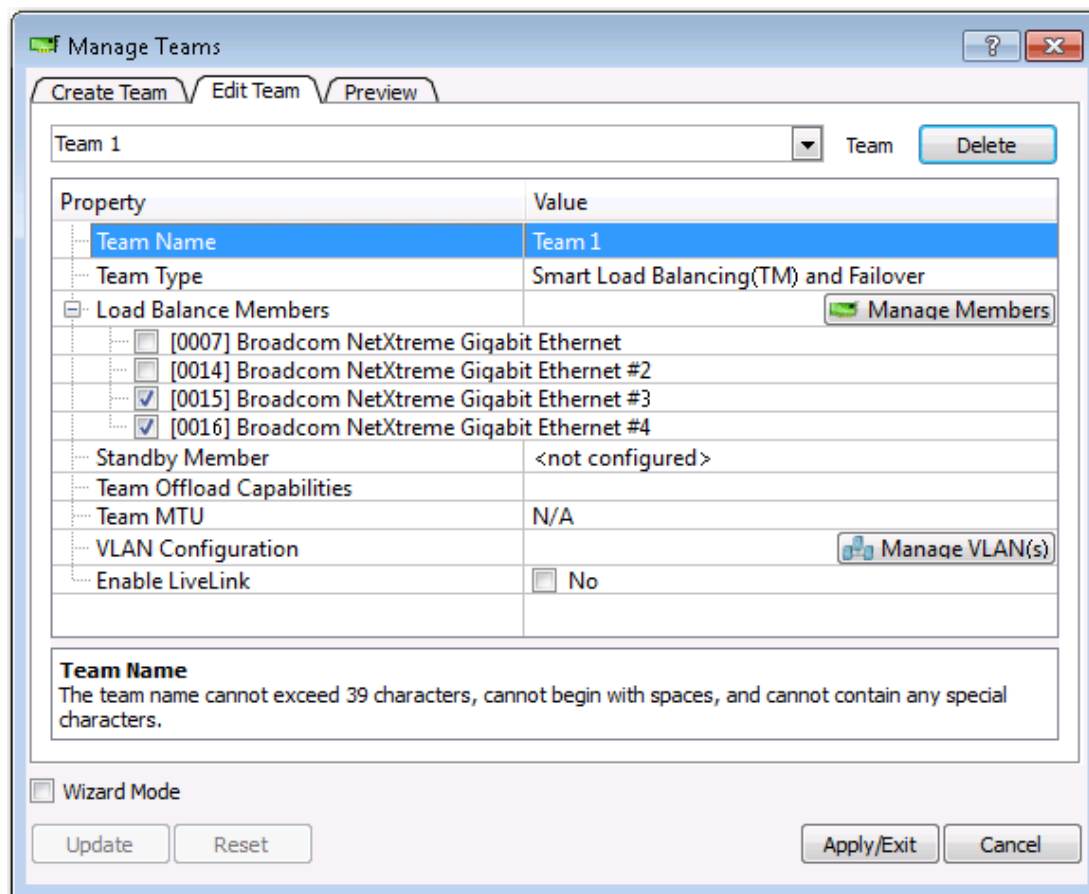

4. Make the desired changes, and then click **Update**. The changes have not yet been applied; click the **Preview** tab to view the updated team structure before applying the changes.
5. Click **Apply/Exit** to apply the updates and exit the Manage Teams window.
6. Click **Yes** when the message is displayed indicating that the network connection will be temporarily interrupted.

Adding a VLAN

You can add virtual LANs (VLANs) to a team. This enables you to add multiple virtual adapters that are on different subnets. The benefit of this is that your system can have one network adapter that can belong to multiple subnets. With a VLAN, you can couple the functionality of load balancing for the load balance members, and you can employ a failover adapter.

You can define up to 64 VLANs per team (63 VLANs that are tagged and 1 VLAN that is not tagged). VLANs can only be created when all teams members are Broadcom adapters. If you try to create a VLAN with a non-Broadcom adapter, an error message is displayed.

To configure a team with a VLAN

1. From the **Teams** menu, select **Add VLAN**.
2. The Welcome screen appears.
3. Click **Expert Mode**.
4. On the **Create Team** tab of the **Manage Teams** window, click **Manage VLAN(s)**.
5. Type the VLAN name, then select the type and ID.
6. Click **Create** to save the VLAN information. As VLANs are defined, they can be selected from the Team Name list, but they have not yet been created.
7. Continue this process until all VLANs are defined, then click **OK** to create them.

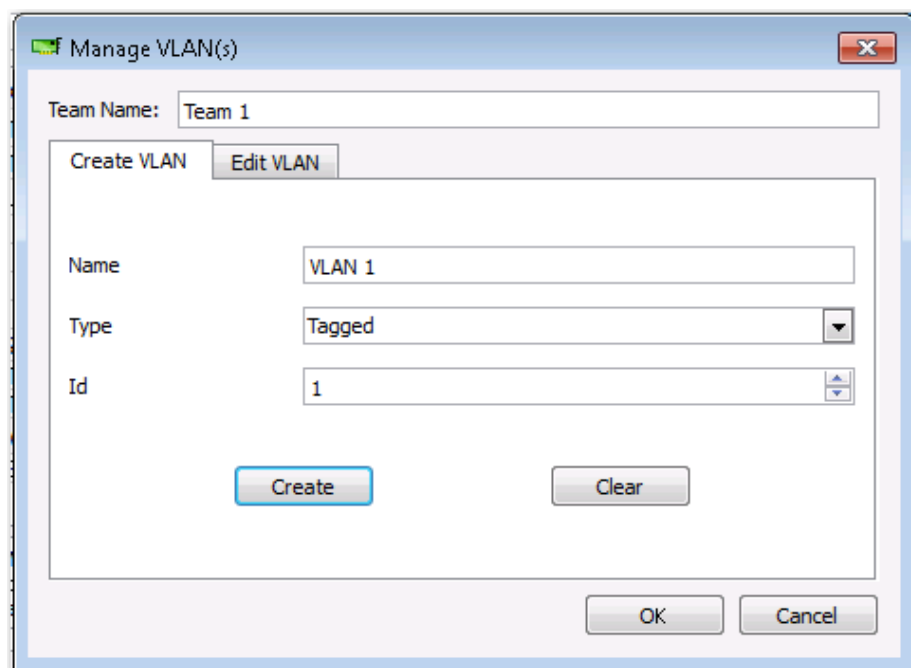

- Click **Yes** when the message is displayed indicating that the network connection will be temporarily interrupted.

 **NOTE:** To maintain optimum adapter performance, your system should have 64 MB of system memory for each of the eight VLANs created per adapter.

Viewing VLAN Properties and Statistics and Running VLAN Tests

To view VLAN properties and statistics and to run VLAN tests

- Select one of the listed VLANs.
- Click the **Information** tab to view the properties of the VLAN adapter.
- Click the **Statistics** tab to view the statistics for the VLAN adapter.
- Click the **Diagnostics** tab to run a network test on the VLAN adapter.

Deleting a VLAN

The procedure below applies when you are in Expert Mode.

To delete a VLAN

- Select the VLAN to delete.
- From the **Teams** menu, select **Remove VLAN**.
- Click **Apply**.
- Click **Yes** when the message is displayed indicating that the network connection will be temporarily interrupted.

 **NOTE:** If you delete a team, any VLANs configured for that team are also deleted.

Configuring LiveLink for a Smart Load Balancing and Failover and SLB (Auto-Fallback Disable) Team

LiveLink is a feature of BASP that is available for the Smart Load Balancing (SLB) and SLB (Auto-Fallback Disable) type of teaming. The purpose of LiveLink is to detect link loss beyond the switch and to route traffic only through team members that have a live link.

Read the following notes before you attempt to configure LiveLink.

NOTES:

- Before you begin configuring LiveLink™, review the description of LiveLink. Also verify that each probe target you plan to specify is available and working. If the IP address of the probe target changes for any reason, LiveLink must be reconfigured. If the MAC address of the probe target changes for any reason, you must restart the team (see the "Troubleshooting" topic in the *NetXtreme II Network Adapter User Guide*).

- A probe target must be on the same subnet as the team, have a valid (not a broadcast, multicast, or unchaste), statically-assigned IP address, and be highly available (always on).
- To ensure network connectivity to the probe target, ping the probe target from the team.
- You can specify up to four probe targets.
- The IP address assigned to either a probe target or team member cannot have a zero as the first or last octet.

To configure LiveLink

1. From the **Teams** menu, select **Edit Team**.
2. Click Expert Mode (to configure LiveLink using the Teaming Wizard, see [Using the Broadcom Teaming Wizard](#)).
3. In the Manage Teams window, click the **Edit Team** tab.
4. Select **Enable LiveLink**. The LiveLink Configuration options appear below.
5. It is recommended to accept the default values for **Probe interval** (the number of seconds between each retransmission of a link packet to the probe target) and **Probe maximum retries** (the number of consecutively missed responses from a probe target before a failover is triggered). To specify different values, click the desired probe interval in the **Probe interval (seconds)** list and click the desired maximum number of probe retries in the **Probe maximum retries** list.
6. Set the **Probe VLAN ID** to correspond with the VLAN where the probe target(s) resides. This will apply the appropriate VLAN tag to the link packet based on the shared configuration of the attached switch port(s).

 **NOTE:** Each LiveLink enabled team can only communicate with Probe Targets on a single VLAN. Also, VLAN ID 0 is equivalent to an untagged network.

7. Select **Probe Target 1** and type the target IP address for one or all probe targets.

 **NOTE:** Only the first probe target is required. You can specify up to 3 additional probe targets to serve as backups by assigning IP addresses to the other probe targets.

8. Select one of the listed team members and type the member IP address.

 **NOTE:** All of the member IP addresses must be in the same subnet as the probe targets.

9. Click **Update**. Repeat these steps for each of the other listed team members.
10. Click **Apply/Exit**.

Saving and Restoring a Team Configuration

To save a configuration

1. From the **File** menu, select **Team Save As**.
2. Type *the path and file name of the new configuration file*, and then click **Save**.

The configuration file is a text file that can be viewed by any text editor. The file contains information about both the adapter and the team configuration.

To restore a configuration

1. From the **File** menu, select **Team Restore**.
2. Click the name of the file to be restored, and then click **Open**.

 **NOTE:** If necessary, go to the folder where the file is located.

3. Click **Apply**.
4. Click **Yes** when the message is displayed indicating that the network connection will be temporarily interrupted.
5. If a configuration is already loaded, a message is displayed that asks if you want to save your current configuration. Click **Yes** to save the current configuration. Otherwise, the configuration data that is currently loaded is lost.

 **Note:** The team may take a very long time to restore if the team is configured with multiple VLANs and each VLAN is configured with one or more static IP addresses.

Viewing BASP Statistics

The Statistics section shows performance information about the network adapters that are on a team.

To view BASP Statistics information for any team member adapter or the team as a whole, click the name of the adapter or team

listed in the Team Management pane, then click the **Statistics** tab.

Click **Refresh** to get the most recent values for each statistic. Click **Reset** to change all values to zero.

Configuring With the Command Line Interface Utility

An alternate method to BACS for configuring Broadcom network adapters is with BACSCLI, which is a Broadcom utility that allows you to view information and configure network adapters using a console in either a non-interactive command line interface (CLI) mode or an interactive mode. As with BACS, BACSCLI provides information about each network adapter, and enables you to perform detailed tests, run diagnostics, view statistics, and modify property values. BACSCLI also allows you the ability to team network adapters together for load balancing and failover.

For a complete list of available commands and examples, see the BACSCLI ReadMe text file on the Dell-provided CD.

On a system with Broadcom NetXtreme I and NetXtreme II network adapters, BACSCLI is installed when BACS is installed with the installer.

Troubleshooting BACS

Problem: When attempting to open BACS on a Linux System, the following error message displays:

"Another instance of the BACS client appears to be running on this system. Only one instance of the BACS client can be running at a time. If you are sure that no other BACS client is running, then a previous instance may have quit unexpectedly."

Solution: This message displays if you try to run a second instance of BACS. If you receive this message but are certain that no instance of BACS is currently running, a previous instance of BACS may have quit unexpectedly. To clear that instance, remove the file `/dev/shm/sem.Global-BACS-{C50398EE-84A7-4bc3-9F6E-25A69603B9C0}`."

[Back to Contents Page](#)

[Back to Contents Page](#)

User Diagnostics in DOS: Broadcom NetXtreme II® Network Adapter User Guide

- [Introduction](#)
- [System Requirements](#)
- [Performing Diagnostics](#)
- [Diagnostic Test Descriptions](#)

Introduction

Broadcom NetXtreme II User Diagnostics is an MS-DOS based application that runs a series of diagnostic tests (see [Table 3](#)) on the Broadcom NetXtreme II network adapters in your system. Broadcom NetXtreme II User Diagnostics also allows you to update device firmware and to view and change settings for available adapter properties. There are two versions of the Broadcom NetXtreme II User Diagnostics: `uxdiag.exe` (for BCM5708/BCM5709 network adapters) and `uediag.exe` (for BCM57710 network adapters).

To run Broadcom NetXtreme II User Diagnostics, create an MS-DOS 6.22 bootable disk containing the `uxdiag.exe` or `uediag.exe` file. Next, start the system with the boot disk in drive A. See [Performing Diagnostics](#) for further instructions on running diagnostic tests on Broadcom network adapters.

System Requirements

Operating System: MS-DOS 6.22

Software: `uxdiag.exe` (BCM5708/BCM5709), or `uediag.exe` (BCM57710)

Performing Diagnostics

At the MS-DOS prompt, type `uxdiag` (for BCM5708/BCM5709 network adapters) or `uediag` (for BCM577XX and BCM578XX network adapters) followed by the command options. The `uxdiag` command options are shown in [Table 1](#) and the `uediag` command options are shown in [Table 2](#). For example, to run all diagnostic tests on adapter #1 except Group B tests:

```
C:\>uxdiag -c 1 -t b
```

 **NOTE:** You must include **uxdiag** or **uediag** at the beginning of the command string each time you type a command.

Table 1: uxdiag Command Options

Command Options	Description
<code>uxdiag</code>	Performs all tests on all Broadcom NetXtreme II adapters in your system.
<code>uxdiag -c <devnum></code>	Specifies the adapter (devnum) to test. Use all in place of a specific device number to test all adapters.
<code>uxdiag -cof</code>	Allows tests to continue after detecting a failure.
<code>uxdiag -F</code>	Forces an upgrade of the image without checking the version.
<code>uxdiag -fbc <bc_image></code>	Specifies the bin file to update the bootcode.
<code>uxdiag -fib <ib_image></code>	Specifies the bin file for iSCSI boot.
<code>uxdiag -fibc</code>	Programs the iSCSI configuration block. Used only with <code>-fib <ib_image></code> .
<code>uxdiag -fibp</code>	Programs the iSCSI configuration software. Used only with <code>-fib <ib_image></code> .
<code>uxdiag -fmba <mba_image></code>	Specifies the bin file to update the MBA.
<code>uxdiag -fncsi <ncsi_image></code>	Specifies the bin file to update the NCSI firmware.

uxdiag -fnvm <raw_image>	Programs the raw image into NVM.
uxdiag -fump <ump_image>	Specifies the bin file to update UMP firmware.
uxdiag -help	Displays the Broadcom NetXtreme II User Diagnostics (uxdiag) command options.
uxdiag -l <iteration num>	Specifies the number of iterations to run on the selected tests.
uxdiag -idmatch	Enables matching of VID, DID, SVID, and SSID from the image file with device IDs. Used only with -fnvm <raw_image>.
uxdiag -log <file>	Logs the test results to a specified log file.
uxdiag -mba <1/0>	Enables/disables Multiple Boot Agent (MBA) protocol. 1 = Enable 0 = Disable
uxdiag -mbap <n>	Sets the MBA boot protocol. 0 = PXE 1 = RPL 2 = BOOTP 3 = iSCSI_Boot
uxdiag -mbas <n>	Sets the MBA/PXE speed. 0 = Auto 1 = 10H 2 = 10F 3 = 100H 4 = 100F 6 = 1000F
uxdiag -mbav <1 0>	Enables/disables MBA VLAN. 1 = Enable 0 = Disable
uxdiag -mbavval <n>	Sets MBA VLAN (<65536).
uxdiag -mfw <1/0>	Enables/disables management firmware. 1 = Enable 0 = Disable
uxdiag -t <groups/tests>	Disables certain groups/tests.
uxdiag -T <groups/tests>	Enables certain groups/tests.
uxdiag -ver	Displays the version of Broadcom NetXtreme II User Diagnostics (uxdiag) and all installed adapters.
uxdiag -wol <1/0>	Enables/disables Magic Packet WOL. 1 = Enable 0 = Disable

Table 2: uediag Command Options

Command Options	Description
uediag	Performs all tests on all Broadcom NetXtreme II adapters in your system.
uediag -c <device#>	Specifies the adapter (device#) to test. Similar to -dev (for backward compatibility).
uediag -cof	Allows tests to continue after detecting a failure.
uediag -dev <device#>	Specifies the adapter (device#) to test.
uediag -F	Forces an upgrade of the image without checking the version.
uediag -fbc <bc_image>	Specifies the bin file to update the bootcode.
uediag -fbc1 <bc1_image>	Specifies the bin file to update bootcode 1.
uediag -fbc2 <bc2_image>	Specifies the bin file to update bootcode 2.
uediag -fl2b <l2b_image>	Specifies the bin file for L2B firmware.
uediag -fib <ib_image>	Specifies the bin file for iSCSI boot.

uediag -fibc	Programs iSCSI configuration block 0. Used only with -fib <ib_image>.
uediag -fibc2	Programs iSCSI configuration block 1. Used only with -fib <ib_image>.
uediag -fibp	Programs iSCSI configuration software. Used only with -fib <ib_image>.
uediag -fmba <mba_image>	Specifies the bin file to update the MBA.
uediag -fnvm <raw_image>	Programs the raw image into NVM.
uediag -fump <ump_image>	Specifies the bin file to update UMP firmware.
uediag -help	Displays the Broadcom NetXtreme II User Diagnostics (uediag) command options.
uediag -l <iteration#>	Specifies the number of iterations to run on the selected tests.
uediag -idmatch	Enables matching of VID, DID, SVID, and SSID from the image file with device IDs: Used only with -fnvm <raw_image>.
uediag -log <logfile>	Logs the tests results to a specified log file.
uediag -mba <1/0>	Enables/disables Multiple Boot Agent (MBA) protocol. 1 = Enable 0 = Disable
uediag -mbap <n>	Sets the MBA boot protocol. 0 = PXE 1 = RPL 2 = BOOTP 3 = iSCSI_Boot
uediag -mbav <1/0>	Enables/disables MBA VLAN. 1 = Enable 0 = Disable
uediag -mbavval <n>	Sets MBA VLAN (<65536>).
uediag -mfw <1/0>	Enables/disables management firmware. 1 = Enable 0 = Disable
uediag -t <groups/tests>	Disables certain groups/tests.
uediag -T <groups/tests>	Enables certain groups/tests.
uediag -ver	Displays the version of Broadcom NetXtreme II User Diagnostics (uediag) and all installed adapters.
uediag -wol <1/0>	Enables/disable Magic Packet WOL. 1 = Enable 0 = Disable

Diagnostic Test Descriptions

The diagnostic tests are divided into four groups: Basic Functional Tests (Group A), Memory Tests (Group B), Block Tests (Group C), and Ethernet Traffic Tests (Group D). The diagnostic tests are listed and described in [Table 3](#).

Table 3: Diagnostic Tests

Test		Description
Number	Name	
Group A: Basic Functional Tests		
A1	Register	Verifies that registers accessible through the PCI/PCIe interface implement the expected read-only or read/write attributes by attempting to modify those registers.
A2	PCI Configuration	Checks the functionality of the PCI Base Address Register (BAR) by varying the amount of memory requested by the BAR and verifying that the BAR actually requests the correct amount of memory (without actually mapping the BAR into system memory). Refer to PCI or PCI-E specifications for details on the BAR and its addressing space.
A3	Interrupt	Generates a PCI interrupt and verifies that the system receives the interrupt and invokes the correct ISR. A negative test is also performed to verify that a masked interrupt does not invoke the ISR.
		Verifies that a Message Signaled Interrupt (MSI) causes an MSI message to be DMA'd to host

A5	MSI	memory. A negative test is also performed to verify that when an MSI is masked, it does not write an MSI message to host memory.
A6	Memory BIST	Invokes the internal chip Built-In Self Test (BIST) command to test internal memory.
Group B: Memory Tests		
B1	TXP Scratchpad	<p>The Group B tests verify all memory blocks of the Broadcom NetXtreme II adapter by writing various data patterns (0x55aa55aa, 0xaa55aa55, walking zeroes, walking ones, address, etc.) to each memory location, reading back the data, and then comparing it to the value written. The fixed data patterns are used to ensure that no memory bit is stuck high or low, while the walking zeroes/ones and address tests are used to ensure that memory writes do not corrupt adjacent memory locations.</p>
B2	TPAT Scratchpad	
B3	RXP Scratchpad	
B4	COM Scratchpad	
B5	CP Scratchpad	
B6	MCP Scratchpad	
B7	TAS Header Buffer	
B8	TAS Payload Buffer	
B9	RBUF via GRC	
B10	RBUF via Indirect Access	
B11	RBUF Cluster List	
B12	TSCH List	
B13	CSCH List	
B14	RV2P Scratchpads	
B15	TBDC Memory	
B16	RBDC Memory	
B17	CTX Page Table	
B18	CTX Memory	
Group C: Block Tests		
C1	CPU Logic and DMA Interface	Verifies the basic logic functionality of all the on-chip CPUs. It also exercises the DMA interface exposed to those CPUs. The internal CPU tries to initiate DMA activities (both read and write) to system memory and then compares the values to confirm that the DMA operation completed successfully.
C2	RBUF Allocation	Verifies the RX buffer (RBUF) allocation interface by allocating and releasing buffers and checking that the RBUF block maintains an accurate count of the allocated and free buffers.
C3	CAM Access	Verifies the content-addressable memory (CAM) block by performing read, write, add, modify, and cache hit tests on the CAM associative memory.
C4	TPAT Cracker	Verifies the packet cracking logic block (i.e., the ability to parse TCP, IP, and UDP headers within an Ethernet frame) as well as the checksum/CRC offload logic. In this test, packets are submitted to the chip as if they were received over Ethernet and the TPAT block cracks the frame (identifying the TCP, IP, and UDP header data structures) and calculates the checksum/CRC. The TPAT block results are compared with the values expected by Broadcom NetXtreme II User Diagnostics and any errors are displayed.
C5	FIO Register	The Fast IO (FIO) verifies the register interface that is exposed to the internal CPUs.
C6	NVM Access and Reset-Corruption	Verifies non-volatile memory (NVM) accesses (both read and write) initiated by one of the internal CPUs. It tests for appropriate access arbitration among multiple entities (CPUs). It also checks for possible NVM corruption by issuing a chip reset while the NVM block is servicing data.

C7	Core-Reset Integrity	Verifies that the chip performs its reset operation correctly by resetting the chip multiple times, checking that the bootcode and the internal uxdiag driver loads/unloads correctly.
C8	DMA Engine	Verifies the functionality of the DMA engine block by performing numerous DMA read and write operations to various system and internal memory locations (and byte boundaries) with varying lengths (from 1 byte to over 4 KB, crossing the physical page boundary) and different data patterns (incremental, fixed, and random). CRC checks are performed to ensure data integrity. The DMA write test also verifies that DMA writes do not corrupt the neighboring host memory.
C9	VPD	Exercises the Vital Product Data (VPD) interface using PCI configuration cycles and requires a proper bootcode to be programmed into the non-volatile memory. If no VPD data is present (i.e., the VPD NVM area is all 0s), the test first initializes the VPD data area with non-zero data before starting the test and restores the original data after the test completes.
C11	FIO Events	Verifies that the event bits in the CPU's Fast IO (FIO) interface are triggering correctly when a particular chip events occur, such as a VPD request initiated by the host, an expansion ROM request initiated by the host, a timer event generated internally, toggling any GPIO bits, or accessing NVM.
Group D: Ethernet Traffic Tests		
D1	MAC Loopback	Enables MAC loopback mode in the adapter and transmits 5000 Layer 2 packets of various sizes. As the packets are received back by Broadcom NetXtreme II User Diagnostics, they are checked for errors. Packets are returned through the MAC receive path and never reach the PHY. The adapter should not be connected to a network.
D2	PHY Loopback	Enables PHY loopback mode in the adapter and transmits 5000 Layer 2 packets of various sizes. As the packets are received back by Broadcom NetXtreme II User Diagnostics, they are checked for errors. Packets are returned through the PHY receive path and never reach the wire. The adapter should not be connected to a network.
D4	LSO	Verifies the functionality of the adapter's Large Send Offload (LSO) support by enabling MAC loopback mode and transmitting large TCP packets. As the packets are received back by Broadcom NetXtreme II User Diagnostics, they are checked for proper segmentation (according to the selected MSS size) and any other errors. The adapter should not be connected to a network.
D5	EMAC Statistics	Verifies that the basic statistics information maintained by the chip is correct by enabling MAC loopback mode and sending Layer 2 packets of various sizes. The adapter should not be connected to a network.
D6	RPC	Verifies the Receive Path Catch-up (RPC) block by sending packets to different transmit chains. The packets traverse the RPC logic (though not the entire MAC block) and return to the receive buffers as received packets. This is another loopback path that is used by Layer 4 and Layer 5 traffic within the MAC block. As packets are received back by Broadcom NetXtreme II User Diagnostics, they are checked for errors. The adapter should not be connected to a network.

Please read all [Restrictions and Disclaimers](#).

[Back to Contents Page](#)

[Back to Contents Page](#)

Specifications: Broadcom NetXtreme II® Network Adapter User Guide

- [10/100/1000BASE-T and 10GBASE-T Cable Specifications](#)
- [Interface Specifications](#)
- [NIC Physical Characteristics](#)
- [NIC Power Requirements](#)
- [Wake On LAN Power Requirements](#)
- [Environmental Specifications](#)

10/100/1000BASE-T and 10GBASE-T Cable Specifications

Table 1: 10/100/1000BASE-T Cable Specifications

Port Type	Connector	Media	Maximum Distance
10BASE-T	RJ-45	Category 3, 4, or 5 unshielded twisted pairs (UTP)	100m (328 feet)
100/1000BASE-T ¹	RJ-45	Category 5 ² UTP	100m (328 feet)

¹ 1000BASE-T signaling requires four twisted pairs of Category 5 balanced cabling, as specified in ISO/IEC 11801:2002 and ANSI/EIA/TIA-568-B.

² Category 5 is the minimum requirement. Category 5e and Category 6 are fully supported.

Table 2: 10GBASE-T Cable Specifications

Port Type	Connector	Media	Maximum Distance
10GBASE-T	RJ-45	Category 6 ¹ UTP Category 6A ¹ UTP	50m (164 feet) 100m (328 feet)

¹ 10GBASE-T signaling requires four twisted pairs of Category 6 or Category 6A (augmented Category 6) balanced cabling, as specified in ISO/IEC 11801:2002 and ANSI/TIA/EIA-568-B.

Supported SFP+ Modules Per NIC

Table 3: BCM57710 Supported Modules

Module Type	Module Vendor	Module Part Number
Optic Modules (SR)	Finisar Corp.	FTLX8571D3BCL
	Avago	AFBR-707SDZ-D1
	Avago	AFBR-703SDZ-D1
	Intel Corp.	FTLX8571D3BCV-IT
Direct Attach Cables	Cisco-Molex Inc.	74752-9093
	Cisco-Molex Inc.	74752-9094
	Cisco-Molex Inc.	74752-9096
	Cisco-Molex Inc.	74752-9098

Table 4: BCM57810 Supported Modules

Module Type and Dell Part Number	Module Vendor	Module Part Number
Optic Modules (SR)		
<ul style="list-style-type: none"> • p/n W365M 	Avago	AFBR-703SDZ-D1

• p/n N743D	Finisar Corp.	FTLX8571D3BCL
• p/n R8H2F	Intel Corp.	AFBR-703SDZ-IN2
	Intel Corp.	FTLX8571D3BCV-IT
Direct Attach Cables		
• p/n K585N	Cisco-Molex Inc.	74752-9093
• p/n J564N	Cisco-Molex Inc.	74752-9094
• p/n H603N	Cisco-Molex Inc.	74752-9096
• p/n G840N	Cisco-Molex Inc.	74752-9098
• p/n 1539W	Brocade	58-1000026-01
• p/n V239T	Brocade	58-1000027-01
• p/n 48V40	Brocade	58-1000023-01
• p/n C4D08 - Force10 1m DAC	Amphenol	599700002
	Amphenol	616740001
• p/n 53HVN - Force10 3m DAC	Amphenol	599700006
	Amphenol	616740003
• p/n 5CN56 - Force10 5m DAC	Amphenol	599700004
	Amphenol	616740005

Table 5: BCM57840 Supported Modules

Module Type and Dell Part Number	Module Vendor	Module Part Number
Optic Modules (SR)		
• p/n R8H2F	Intel Corp.	AFBR-703SDZ-IN2
	Intel Corp.	FTLX8571D3BCV-IT
Direct Attach Cables		
• p/n K585N	Cisco-Molex Inc.	74752-9093
• p/n J564N	Cisco-Molex Inc.	74752-9094
• p/n H603N	Cisco-Molex Inc.	74752-9096
• p/n G840N	Cisco-Molex Inc.	74752-9098
• p/n 1539W	Brocade	58-1000026-01
• p/n V239T	Brocade	58-1000027-01

• p/n 48V40	Brocade	58-1000023-01
• p/n C4D08 - Force10 1m DAC	Amphenol	599700002
	Amphenol	616740001
• p/n 53HVN - Force10 3m DAC	Amphenol	599700006
	Amphenol	616740003
• p/n 5CN56 - Force10 5m DAC	Amphenol	599700004
	Amphenol	616740005

Interface Specifications

Table 6: 10/100/1000BASE-T Performance Specifications

Feature	Specification
PCI Express Interface	x4 link width
10/100/1000BASE-T	10/100/1000 Mbps

Table 7: 10GBASE-T Performance Specifications

Feature	Specification
PCI Express Interface	x8 link width
10GBASE-T	10 Gbps

NIC Physical Characteristics

PCI

Table 8: NIC Physical Characteristics

NIC Type	NIC Length	NIC Width
BCM5708 PCI Express	14.7 cm (5.79 inches)	6.4 cm (2.52 inches)
BCM5709/BCM5716 PCI Express x4 low-profile	11.9 cm (4.7 inches)	6.9 cm (2.7 inches)
BCM57710/BCM57711/BCM57712 PCI Express x8 low profile	16.8 cm (6.6 inches)	5.1 cm (2.0 inches)
BCM57810S PCI Express x8 low profile	16.8 cm (6.6 inches)	6.5 cm (2.54 inches)
BCM957840A4006G PCI Express x8 Mezzanine Card	14.4 cm (5.66 inches)	11.1 cm (4.370 inches)
BCM957840A4007G PCI Express x8 Mezzanine Card	10.9 cm (4.28 inches)	7.5 cm (2.97 inches)

NIC Power Requirements

Table 9: BCM5708C NIC Power Requirements

Link	NIC 3.3V Current Draw (A)	NIC Power (W)
Idle (no link)	1.44	4.75
1 Gbit	1.97	6.50
100 Mbit	1.60	5.28
10 Mbit	1.62	5.35

Table 10: BCM5709C/BCM5716 NIC Power Requirements

Link	NIC 3.3V Current Draw (A)	NIC Power (W)
Idle (no link)	1.01	3.32
1 Gbit	1.43	4.71
100 Mbit	1.16	3.81

10 Mbit	1.12	3.71
---------	------	------

Table 11: BCM57710/BCM57711/BCM57712 NIC Power Requirements

Link	NIC 12V Current Draw (A)	NIC 3.3V Current Draw (A)	NIC Power (W) ¹
Idle (no link)	0.60	0.28	8.12
Low power mode	0.50	0.35	7.16
10GBASE-T link	1.23	1.79	20.67
10GBASE-T traffic	1.24	1.95	21.32

Note: ¹Power, measured in watts (W), is a direct calculation of total current draw (A) multiplied by voltage (V). The maximum power consumption for the adapter will not exceed 30W.

Table 12: BCM957810A1006G NIC Power Requirements

Link	NIC 12V Current Draw (A)	NIC 3.3V Current Draw (A)	NIC Power (W) ¹
10 SFP Module	1.37	0.004	16.41

¹Power, measured in watts (W), is a direct calculation of total current draw (A) multiplied by voltage (V). The maximum power consumption for the adapter will not exceed 30W.

Table 13: BCM957810A1008G NIC Power Requirements

Link	NIC 12V Current Draw (A)	NIC 3.3V Current Draw (A)	NIC Power (W) ¹
Idle (no link)	0.58	0.004	6.88
100BASE-T link	0.67	0.004	8.07
1000BASE-T link	0.83	0.004	9.90
10GBASE-T link	1.37	0.004	16.41

¹Power, measured in watts (W), is a direct calculation of total current draw (A) multiplied by voltage (V). The maximum power consumption for the adapter will not exceed 30W.

Table 14: BCM957840A4006G Mezzanine Card Power Requirements

Link	Total Power (12V and 3.3VAUX) (W) ¹
Idle (no link)	7.206
PCIe Disable	6.634
Play Dead Mode	4.078
1000BASE-T link	8.53
10GBASE-T link	8.89
Standby WOL Enabled	4.7064
Standby WOL Disabled	0.4791W

¹Power, measured in watts (W), is a direct calculation of total current draw (A) multiplied by voltage (V). The maximum power consumption for the adapter will not exceed 30W.

Table 15: BCM957840A4007G Mezzanine Card Power Requirements

Link	Total Power (3.3V) (W) ¹
Idle (no link)	5.7
Standby mode	2.2
1000BASE-T link	6.2
10GBASE-T link	6.5

¹Power, measured in watts (W), is a direct calculation of total current draw (A) multiplied by voltage (V). The maximum power consumption for the adapter will not exceed 30W.

Wake On LAN Power Requirements

Nominal power:

- BCM957810A1006G: 3.0W
- BCM957810a1008G: 4.5W

The tables below show the Wake On LAN power requirements for 1G adapters.

Table 16: BCM5708C Wake On LAN Power Requirements (Nominal Conditions)

100 Mbit Link		10 Mbit Link	
NIC 3.3V Current (mA)	NIC Power (W)	NIC 3.3V Current (mA)	NIC Power (W)
236	0.78	150	0.5

Table 17: BCM5709C and BCM5716 Wake On LAN Power Requirements (Nominal Conditions)

100 Mbit Link		10 Mbit Link	
NIC 3.3V Current (mA)	NIC Power (W)	NIC 3.3V Current (mA)	NIC Power (W)
0	0.87	0	0.85

Environmental Specifications

Table 18: BCM5708 Environmental Specifications

Condition	Operating Specification	Storage Specification
Temperature	0°C to 55°C (+32°F to +131°F)	-40°C to +85°C (-40°F to +185°F)
Relative humidity	5% to 85% (noncondensing) 40°C, 16 hour dwells at extremes	5% to 95% (noncondensing) 10°C/hour
Altitude	Up to 10,000 ft.	Up to 35,000 ft.
Shock	10g, 1/2 sine wave, 11 ms	60g, 1/2 sine wave, 11 ms
Vibration, peak to peak displacement	0.005 in. max (5 Hz to 32 Hz)	0.1 in. max (5 Hz to 17 Hz)
Vibration, peak acceleration	0.25g (5 Hz to 500 Hz) (Sweep Rate = 1 octave/min.)	0.25g (5 Hz to 500 Hz) (Sweep Rate = 1 octave/min.)

Table 19: BCM5709 and BCM5716 Environmental Specifications

Parameter	Condition
Operating Temperature	0°C to 55°C
Air Flow Requirement (LFM)	0
Storage Temperature	-40°C to +65°C
Storage Humidity	5% to 95% condensing
Vibration and Shock	IEC 68, FCC Part 68.302, NSTA, 1A
Electrostatic/Electromagnetic Susceptibility	EN 61000-4-2, EN 55024

Table 20: BCM957810A1006G Environmental Specifications

Parameter	Condition
Operating Temperature	0°C to 55°C
Air Flow Requirement (LFM)	100
Storage Temperature	-40°C to +65°C
Storage Humidity	5% to 95% condensing
Vibration and Shock	IEC 68, FCC Part 68.302, NSTA, 1A
Electrostatic/Electromagnetic Susceptibility	IEC 801-2, 3, 4, 5

Table 21: BCM957810A1008G Environmental Specifications

Parameter	Condition
Operating Temperature	0°C to 55°C
Air Flow Requirement (LFM)	50
Storage Temperature	-40°C to +65°C
Storage Humidity	5% to 95% condensing
Vibration and Shock	IEC 68, FCC Part 68.302, NSTA, 1A
Electrostatic/Electromagnetic Susceptibility	IEC 801-2, 3, 4, 5

Table 22: BCM957840A4006G Environmental Specifications

Parameter	Condition
Operating Temperature	0°C to 60°C
Air Flow Requirement (LFM)	100
Storage Temperature	-40°C to +65°C
Storage Humidity	5% to 95% condensing
Vibration and Shock	IEC 68, FCC Part 68.302, NSTA, 1A
Electrostatic/Electromagnetic Susceptibility	IEC 801-2, 3, 4, 5

Table 23: BCM957840A4007G Environmental Specifications

Parameter	Condition
Operating Temperature	0°C to 65°C
Air Flow Requirement (LFM)	200
Storage Temperature	-40°C to +65°C
Storage Humidity	5% to 95% condensing
Vibration and Shock	IEC 68, FCC Part 68.302, NSTA, 1A
Electrostatic/Electromagnetic Susceptibility	IEC 801-2, 3, 4, 5

Please read all [Restrictions and Disclaimers](#).

[Back to Contents Page](#)

[Back to Contents Page](#)

Regulatory Information: Broadcom NetXtreme II® Network Adapter User Guide

- [FCC Notice](#)
- [VCCI Notice](#)
- [CE Notice](#)
- [Canadian Regulatory Information \(Canada Only\)](#)
- [Korea Communications Commission \(KCC\) Notice \(Republic of Korea Only\)](#)
- [BSMI](#)
- [Certifications for BCM95709SA0908G, BCM957710A1023G, E02D001, and BCM957711A1123G \(E03D001\)](#)

FCC Notice

FCC, Class B

Broadcom NetXtreme II Gigabit Ethernet Controller

- BCM95708A0804F
- BCM95709A0907G
- BCM95709A0906G
- BCM957810A1008G

Broadcom Corporation
190 Mathilda Place
Sunnyvale, California 94086 USA

The equipment complies with Part 15 of the FCC Rules. Operation is subject to the following two conditions: 1) The device may not cause harmful interference, and 2) This equipment must accept any interference received, including interference that may cause undesired operation.

The equipment has been tested and found to comply with the limits for a Class B digital device, pursuant to Part 15 of the FCC Rules. These limits are designed to provide reasonable protection against harmful interference in a residential installation. The equipment generates, uses and can radiate radio-frequency energy and, if not installed and used in accordance with the instructions, may cause harmful interference to radio communications. However, there is no guarantee that interference will not occur in a particular installation. If the equipment does cause harmful interference to radio or television reception, which can be determined by turning the equipment off and on, the user is encouraged to try to correct the interference by one or more of the following measures:

- Reorient or relocate the receiving antenna.
- Increase the separation between the equipment and the receiver.
- Connect the equipment into an outlet on a circuit different from that to which the receiver is connected.
- Consult the dealer or an experienced radio/TV technician for assistance.

Do not make mechanical or electrical modifications to the equipment.

 **NOTE:** If the device is changed or modified without permission of Broadcom, the user may void his or her authority to operate the equipment.

FCC, Class A

Broadcom NetXtreme II Gigabit Ethernet Controller

- BCM95709A0916G

Broadcom NetXtreme II 10 Gigabit Ethernet Controller

- BCM957710A1022G
- BCM957710A1021G
- BCM957711A1113G
- BCM957711A1102G
- BCM957810A1006G
- BCM957840A4006G
- BCM957840A4007G

Broadcom Corporation
190 Mathilda Place
Sunnyvale, California 94086 USA

This device complies with Part 15 of the FCC Rules. Operations is subject to the following two conditions: 1) This device may not cause harmful interference, and 2) This device must accept any interference received, including interference that may cause undesired operation.

This product has been tested and found to comply with the limits for a Class A digital device pursuant to Part 15 of the FCC Rules. These limits are designed to provide reasonable protection against harmful interference when the equipment is operated in a commercial environment. This product generates, uses, and can radiate radio frequency energy and, if not installed and used in accordance with the manufacturer's instruction manual, may cause harmful interference with radio communications. Operation of this product in a residential area is likely to cause harmful interference, in which case you will be required to correct the interference at your own expense.

These limits are designed to provide reasonable protection against harmful interference in a non-residential installation. However, there is no guarantee that interference will not occur in a particular installation. If this equipment does cause harmful interference with radio or television reception, which can be determined by turning the equipment off and on, you are encouraged to try to correct the interference by one or more of the following measures:

- Reorient the receiving antenna.
- Relocate the system with respect to the receiver.
- Move the system away from the receiver.
- Plug the system into a different outlet so that the system and receiver are on different branch circuits.

Do not make mechanical or electrical modifications to the equipment.

 **NOTE:** If the device is changed or modified without permission of Broadcom, the user may void his or her authority to operate the equipment.

VCCI Notice

Class B

Broadcom NetXtreme II Gigabit Ethernet Controller

- BCM95708A0804F
- BCM95709A0907G
- BCM95709A0906G
- BCM957810A1008G

Broadcom Corporation
190 Mathilda Place
Sunnyvale, California 94086 USA

The equipment is a Class B product based on the standard of the Voluntary Control Council for Interference from Information Technology Equipment (VCCI). If used near a radio or television receiver in a domestic environment, it may cause radio interference. Install and use the equipment according to the instruction manual.

⚠ CAUTION! The potential exists for this equipment to become impaired in the presence of conducted radio frequency energy between the frequency range of 59–66 MHz. Normal operation will return upon removal of the RF energy source.

VCCI Class B Statement (Japan)

この装置は、情報処理装置等電波障害自主規制協議会（VCCI）の基準に基づくクラス B 情報技術装置です。この装置は、家庭環境で使用することを目的としていますが、この装置がラジオやテレビジョン受信機に近接して使用されると、電波障害を引き起こすことがあります。取扱説明書に従って正しい取り扱いをして下さい。

Class A

Broadcom NetXtreme II Gigabit Ethernet Controller

- BCM95709A0916G

Broadcom NetXtreme II 10 Gigabit Ethernet Controller

- BCM957710A1022G
- BCM957710A1021G
- BCM957711A1113G
- BCM957711A1102G
- BCM957840A4006G
- BCM957840A4007G

Broadcom Corporation
190 Mathilda Place
Sunnyvale, California 94086 USA

This equipment is a Class A product based on the standard of the Voluntary Control Council for interference by Information Technology Equipment (VCCI). If used in a domestic environment, radio disturbance may arise. Install and use the equipment according to the instruction manual.

VCCI Class A Statement (Japan)

この装置は、情報処理装置等電波障害自主規制協議会（VCCI）の基準に基づくクラス A 情報技術装置です。この装置を家庭環境で使用すると電波障害を引き起こす可能性があります。この場合には使用者が適切な対策を講ずるよう要求されることがあります。

CE Notice

Class C

- BCM957810A1008G

Class B

Broadcom NetXtreme II Gigabit Ethernet Controller

- BCM95708A0804F
- BCM95709A0907G
- BCM95709A0906G

Class A

Broadcom NetXtreme II Gigabit Ethernet Controller

- BCM95709A0916G

Broadcom NetXtreme II 10 Gigabit Ethernet Controller

- BCM957710A1022G
- BCM957710A1021G
- BCM957711A1113G
- BCM957711A1102G
- BCM957840A4006G
- BCM957840A4007G

БЪЛГАРСКИ Bulgarian	<p>Този продукт отговаря на 2006/95/EC (Нисковолтова директива), 2004/108/EC (Директива за електромагнитна съвместимост) и измененията на Европейския съюз.</p> <p>Изготвена е "Декларация за съответствие" според горепосочените директиви и стандарти, която се съхранява в Broadcom Corporation, 190 Mathilda Place, Sunnyvale, California 94086, USA.</p> <p>Европейски съюз, Клас B Това устройство на Broadcom е класифицирано за използване в типичната за Клас B жилищна среда.</p> <p>Европейски съюз, Клас A ВНИМАНИЕ: Това е продукт от Клас A. В жилищна среда този продукт може да създаде радиочестотни смущения, в който случай потребителят ще трябва да вземе съответните мерки.</p>
ČESKÝ Czech	<p>Bylo ustanoveno, že tento produkt splňuje směrnici 2006/95/EC (nízkonapětová směrnice), směrnici 2004/108/EC (směrnice EMC) a dodatky Evropské unie.</p> <p>„Prohlášení o shodě“ v souladu s výše uvedenými směrnici a normami bylo zpracováno a je uloženo v archivu společnosti Broadcom Corporation, 190 Mathilda Place, Sunnyvale, California 94086, USA.</p> <p>Evropská unie, třída B Toto zařízení společnosti Broadcom je klasifikováno pro použití v obvyklém prostředí domácnosti (třída B).</p> <p>Evropská unie, třída A VAROVÁNÍ: Toto je produkt třídy A. V domácím prostředí může tento produkt způsobovat rušení rádiových frekvencí, a v takovém případě se od uživatele vyžaduje, aby učinil odpovídající opatření.</p>
Danish	<p>Denne produkt er fundet i overensstemmelse med 2006/95/EC (Lavvoltsdirektivet), 2004/108/EC (EMC-direktivet) og den Europæiske Unions ændringer.</p> <p>En "Overensstemmelseserklæring", som er i henhold til foregående direktiver og standarder, er udført og arkiveret hos Broadcom Corporation, 190 Mathilda Place, Sunnyvale, California 94086, USA.</p> <p>Den Europæiske Union, Klasse B Denne Broadcom-enhed er klassificeret til anvendelse i et typisk Klasse B-hjemligt miljø.</p> <p>Europæiske Union, Klasse A ADVARSEL: Dette er et Klasse A-produkt. I et hjemligt miljø kan dette produkt medføre forstyrrelse af radiofrekvens, og i det tilfælde må brugeren fortage passende foranstaltninger.</p>
NEDERLANDS Dutch	<p>Dit product is in overeenstemming bevonden met 2006/95/EC (Laagspanningsrichtlijn), 2004/108/EC (EMC-richtlijn) en amendementen van de Europese Unie.</p> <p>Een "Verklaring van conformiteit" in overeenstemming met de voorgenoemde richtlijnen en standaarden is beschikbaar bij Broadcom Corporation, 190 Mathilda Place, Sunnyvale, California 94086, USA.</p> <p>Europese Unie/Klasse B Dit Broadcom-apparaat is geïnclassificeerd voor gebruik in een typische klasse B woonomgeving.</p> <p>Europese Unie/Klasse A VOORZICHTIG: Dit is een Klasse A-product. Binnen een woonomgeving kan dit product radiofrequente storingen veroorzaken, in welk geval de gebruiker passende maatregelen dient te nemen.</p>
English	<p>This product has been determined to be in compliance with 2006/95/EC (Low Voltage Directive), 2004/108/EC (EMC Directive), and amendments of the European Union.</p> <p>A "Declaration of Conformity" in accordance with the preceding directives and standards has been made and is on file at Broadcom Corporation, 190 Mathilda Place, Sunnyvale, California 94086, USA.</p> <p>European Union, Class B This Broadcom device is classified for use in a typical Class B domestic environment.</p> <p>European Union, Class A WARNING: This is a Class A product. In a domestic environment this product may cause radio frequency interference in which case the user may be required to take adequate measures.</p>

EESTLANE Estonian	<p>Antud toode vastab direktiividele 2006/95/EU (Madalpinge direktiiv), 2004/108/EÜ (EMC direktiiv) ja ELi parandustele.</p> <p>Vastavalt ülalloodud direktiividele ja standarditele on koostatud „Vastavusdeklaratsioon”, mis on arvel ettevõttes Broadcom Corporation, 190 Mathilda Place, Sunnyvale, California 94086, USA.</p> <p>Euroopa Liit, Klass B</p> <p>Antud Broadcom toode on klassifitseeritud kasutamiseks tüüpilises B-klassi koduses keskkonnas.</p> <p>Union européenne, classe A</p> <p>AVERTISSEMENT : Ce produit est un produit de classe A. Dans un environnement résidentiel, ce produit peut provoquer des perturbations radioélectriques, auquel cas l'utilisateur peut se voir obligé de prendre les mesures appropriées.</p>
Finnish	<p>Tämä tuote täyttää Euroopan unionin direktiivin 2006/95/EY (pienjännitedirektiivi) ja direktiivin 2004/108/EY (sähkömagneettisesta yhteensopivuudesta annettu direktiivi), sellaisina kuin ne ovat muutettuina, vaatimukset.</p> <p>Yllä mainittujen direktiivien ja standardien mukainen vaatimustenmukaisuusvakuutus on tehty, ja sitä säilyttää Broadcom Corporation, 190 Mathilda Place, Sunnyvale, California 94086, USA.</p> <p>Euroopan unioni, luokka B</p> <p>Tämä Broadcom-laite on luokiteltu käytettäväksi tyypillisessä luokan B kotiympäristössä.</p> <p>Euroopan unioni, Luokka A</p> <p>VAROITUS: Tämä on Luokan A tuote. Asuinympäristössä tämä laite saattaa aiheuttaa radiotaajuushäiriöitä, mikä saattaa edellyttää toimia laitteen käyttäjältä.</p>
FRANÇAIS French	<p>Ce produit a été déclaré conforme aux directives 2006/95/EC (Directive sur la faible tension), 2004/108/EC (Directive EMC) et aux amendements de l'Union européenne.</p> <p>Une « Déclaration de Conformité » relative aux normes et directives précédentes a été rédigée et est enregistrée auprès de Broadcom Corporation, 190 Mathilda Place, Sunnyvale, California 94086, USA.</p> <p>Union européenne, classe B</p> <p>Cet appareil Broadcom est classé pour une utilisation dans un environnement résidentiel classique (classe B).</p> <p>Union européenne, classe A</p> <p>AVERTISSEMENT : Ce produit est un produit de classe A. Dans un environnement résidentiel, ce produit peut provoquer des perturbations radioélectriques, auquel cas l'utilisateur peut se voir obligé de prendre les mesures appropriées.</p>
DEUTSCH German	<p>Es ist befunden worden, dass dieses Produkt in Übereinstimmung mit 2006/95/EC (Niederspannungs-Richtlinie), 2004/108/EC (EMV-Richtlinie) und Ergänzungen der Europäischen Union steht.</p> <p>Eine Konformitätserklärung in Übereinstimmung mit den oben angeführten Normen ist abgegeben worden und kann bei Broadcom Corporation, 190 Mathilda Place, Sunnyvale, California 94086, USA.</p> <p>Europäische Union, Klasse B</p> <p>Dieses Gerät von Broadcom ist für die Verwendung in einer typisch häuslichen Umgebung der Klasse B vorgesehen.</p> <p>Europäische Union, Klasse A</p> <p>WARNUNG: Dies ist ein Produkt der Klasse A. In einer häuslichen Umgebung kann dieses Produkt Hochfrequenzstörungen verursachen. In diesem Fall muss der Benutzer die entsprechenden Maßnahmen treffen.</p>
ΕΛΛΗΝΙΚΟΣ Greek	<p>Το προϊόν αυτό συμμορφώνεται με τις οδηγίες 2006/95/ΕΕ (Οδηγία περί χαμηλής τάσης), 2004/108/ΕΕ (Οδηγία περί ηλεκτρομαγνητικής συμβατότητας), και τροποποιήσεις τους από την Ευρωπαϊκή Ένωση.</p> <p>Μία «Δήλωση Συμμόρφωσης» σύμφωνα με τις προηγούμενες οδηγίες και πρότυπα υπάρχει και είναι αρχειοθετημένη στο Broadcom Corporation, 190 Mathilda Place, Sunnyvale, California 94086, USA.</p> <p>Ευρωπαϊκή Ένωση, Κατηγορία Β</p> <p>Αυτή η συσκευή Broadcom είναι κατάλληλη για χρήση σε ένα σύνθετες οικιακό περιβάλλον κατηγορίας Β.</p> <p>Ευρωπαϊκή Ένωση, Κατηγορία Α</p> <p>ΠΡΟΕΙΔΟΠΟΙΗΣΗ: Αυτό είναι ένα προϊόν κατηγορίας Α. Σε οικιακό περιβάλλον, αυτό το προϊόν μπορεί να προκαλέσει παρεμβολές ραδιοσυχνότητας (RF), στην οποία περίπτωση μπορεί να απαιτηθεί η λήψη κατάλληλων μέτρων από τον χρήστη.</p>

MAGYAR Hungarian	<p>A termék megfelel a 2006/95/EGK (alacsony feszültségű eszközökre vonatkozó irányelv), a 2004/108/EGK (EMC irányelv) és az Európai Unió ajánlásainak.</p> <p>Az előbbieken ismertetett irányelvek és szabványok szellemében „Megfelelőségi nyilatkozat” készült, amely az irországi Broadcom Corporation, 190 Mathilda Place, Sunnyvale, California 94086, USA.</p> <p>Európai Unió, „B” osztály Ez a Broadcom eszköz „B” osztályú besorolást kapott, tipikus lakossági környezetben való használatra alkalmas.</p> <p>Európai Unió, „A” osztály FIGYELEM! „A” osztályba sorolt termék. Lakóhelyi környezetben ez a termék rádiófrekvenciás (RF) interferenciát okozhat, ebben az esetben a felhasználónak gondoskodnia kell a szükséges ellenintézkedésekről.</p>
PORTUGUES Iberian Portuguese	<p>Este produto está em conformidade com 2006/95/EC (Directiva de baixa tensão), com 2004/108/EC (Directiva de compatibilidade electromagnética) e com as alterações da União Europeia.</p> <p>Foi elaborada uma “declaração de conformidade” de acordo com as normas e directivas anteriores, encontrando-se arquivada na Broadcom Corporation, 190 Mathilda Place, Sunnyvale, California 94086, USA.</p> <p>União Europeia, Classe B Este dispositivo Broadcom está classificado para utilização num ambiente doméstico típico Classe B.</p> <p>União Europeia, Classe A ADVERTENCIA: Este é um produto Classe A. Num ambiente doméstico, este produto pode provocar interferências de frequência de rádio, podendo ser necessário que o utilizador adopte as medidas adequadas.</p>
ITALIANO Italian	<p>Il presente prodotto è stato determinato essere conforme alla 2006/95/CE (Direttiva Bassa Tensione), alla 2004/108/CE (Direttiva CEM) e a rettifiche da parte dell'Unione Europea.</p> <p>Una “Dichiarazione di conformità” secondo gli standard e le direttive precedenti è stata emessa e registrata presso Broadcom Corporation, 190 Mathilda Place, Sunnyvale, California 94086, USA.</p> <p>Unione Europea, Classe B Il presente dispositivo Broadcom è classificato per l'uso nel tipico ambiente domestico di Classe B.</p> <p>Unione Europea, Classe A AVVERTENZA: Questo prodotto è classificato come Classe A. In un ambiente domestico il presente prodotto potrebbe provocare interferenze di radiofrequenza, nel qual caso potrebbe essere richiesto all'utente di adottare misure adeguate.</p>
LATVISKS Latvian	<p>Šis izstrādājums atbilst direktīvām 2006/95/EK (Direktīva par zemsprieguma iekārtām), 2004/108/EK (Direktīva par elektromagnētisko saderību) un to labojumiem Eiropas Savienības ietvaros.</p> <p>“Atbilstības deklarācija”, kas ir saskaņā ar iepriekšminētajām direktīvām un standartiem, ir sastādīta un tiek glabāta firmā Broadcom Corporation, 190 Mathilda Place, Sunnyvale, California 94086, USA.</p> <p>Eiropas Savienība, klase B Šī firmas Broadcom ražotā ierīce ir atzīta par derīgu darbam B klasei atbilstošos mājas apstākļos.</p> <p>Eiropas Savienība, A klase BRĪDINĀJUMS. Šis A klases izstrādājums. Izmantojot šo izstrādājumu mājas apstākļos, tas var radīt radiotraucējumus; šajā gadījumā lietotājam var būt nepieciešams veikt atbilstošus pasākumus.</p>
Lithuanian	<p>Buvo nustatyta, kad šis produktas atitinka direktyvą 73/23/EEB (žemos įtampos direktyva), 89/336/EEB (elektromagnetinio suderinamumo direktyva) ir Europos Sąjungos pataisas.</p> <p>Atitikties deklaracija pagal visas galiojančias direktyvas ir standartus yra sudaryta ir saugoma irrašyta faile Broadcom Corporation, 190 Mathilda Place, Sunnyvale, California 94086, USA.</p> <p>Europos Sąjunga, B klasė Šis „Broadcom” prietaisas yra klasifikuotas naudoti įprastose B klasės gyvenamosiose aplinkose.</p> <p>Europos Sąjunga, A klasė ĮSPĖJIMAS. Tai yra A klasės produktas. Gyvenamosiose aplinkose šis produktas gali kelti radijo dažnių trikdžius. Tokiu atveju naudotojui gali reikėti imtis atitinkamų priemonių.</p>

Maltese	<p>Gie stabbilit li dan il-prodott hu konformi ma' 2006/95/KE (Direttiva dwar il-Vultagg Baxx), 2004/108/KE (Direttiva EMC), u emendi ta' l-Unjoni Ewropea.</p> <p>Saret "Dikjarazzjoni ta' Konformita'" b'konformita' mad-direttivi u ma' l-istandards imsemmijin qabel, u din tinsab iffajljata għand Broadcom Corporation, 190 Mathilda Place, Sunnyvale, California 94086, USA.</p> <p>Unjoni Ewropea, Klassi B Dan it-tagħmir Broadcom hu kklassifikat għall-użu f'ambjent residenzjali tipiku ta' Klassi B.</p> <p>Unjoni Ewropea, Klassi A TWISSIJA: Dan huwa prodott ta' Klassi A. F'ambjent domestiku dan il-prodott jista' jikkawża interferenza tal-frekwenza tar-radju (RF), f'liema każ l-utent jista' jkun meħtieġ li jiehu miżuri adegwati.</p>
POLSKI Polish	<p>Niniejszy produkt został określony jako zgodny z dyrektywą niskonapięciową 2006/95/WE i dyrektywą zgodności elektromagnetycznej 2004/108/WE oraz poprawkami do nich.</p> <p>Zgodnie ze stosownymi dyrektywami i normami została sporządzona „Deklaracja zgodności”, która jest dostępna w aktach firmy Broadcom Corporation, 190 Mathilda Place, Sunnyvale, California 94086, USA.</p> <p>Unia Europejska, klasa B Niniejsze urządzenie firmy Broadcom zostało zakwalifikowane do klasy B, do użytku w typowych środowiskach domowych.</p> <p>Unia Europejska, klasa A OSTRZEŻENIE: Urządzenie to jest urządzeniem klasy A. W warunkach domowych urządzenie to może wywoływać zakłócenia o częstotliwości radiowej, wymagające od użytkownika podjęcia odpowiednich działań zaradczych.</p>
ROMÂN Romanian	<p>S-a stabilit că acest produs respectă cerințele Directivei 2006/95/CE privind echipamentele de joasă tensiune, ale Directivei 2004/108/CE (Directiva EMC) privind compatibilitatea electromagnetică și ale amendamentelor Uniunii Europene.</p> <p>Conform directivelor și standardelor de mai sus, a fost emisă o „Declarație de Conformitate”, arhivată la sediul Broadcom Corporation, 190 Mathilda Place, Sunnyvale, California 94086, USA.</p> <p>Uniunea Europeană, Clasa B Acest echipament Broadcom este clasificat pentru utilizare într-un mediu casnic tipic de Clasă B.</p> <p>Uniunea Europeană, Clasa A AVERTISMENT: Acesta este un produs din Clasa A. În mediul casnic, acest produs poate cauza interferențe radio, caz în care utilizatorul trebuie să ia măsurile necesare.</p>
SLOVENSKÝ Slovakian	<p>Tento výrobok vyhovuje požiadavkám smernice 2006/95/EC (smernica o nízkom napätí), 2004/108/EC (smernica o elektromagnetickej kompatibilite) a neskorším zmenám a doplnkom Európskej.</p> <p>„Vyhlásenie o zhode“ vydané v súlade s predchádzajúcimi smernicami a štandardmi sa nachádza v spoločnosti Broadcom Corporation, 190 Mathilda Place, Sunnyvale, California 94086, USA.</p> <p>Európska únia, Trieda B Toto zariadenie Broadcom triedy B je určené pre domáce prostredie.</p> <p>Európska únia, Trieda A VAROVANIE: Toto je zariadenie triedy A. V domácom prostredí môže tento produkt spôsobovať rušenie rádiových frekvencií. V takom prípade musí používateľ prijať príslušné opatrenia.</p>
Slovenian	<p>Ta izdelek je v skladu z 2006/95/ES (Direktiva o nizki napetosti), 2004/108/ES (Direktiva o elektromagnetni združljivosti) in dopolnili Evropske unije.</p> <p>«Izjava o skladnosti» je bila sprejeta v skladu s predhodnimi direktivami in standardi in je shranjena na naslovu Broadcom Corporation, 190 Mathilda Place, Sunnyvale, California 94086, USA.</p> <p>Evropska unija, razred B Ta Broadcomova naprava je razvrščena za uporabo v značilnem bivalnem okolju razreda B.</p> <p>Evropska unija, razred A OPOZORILO: To je izdelek razreda A. V domačem okolju lahko ta izdelek povzroča motnje radijskih frekvenc, v tem primeru mora uporabnik ustrezno ukrepati.</p>

ESPAÑOL Spanish	<p>Este producto se ha fabricado de conformidad con la Directiva para bajo voltaje 2006/95/EC (Low Voltage Directive), la Directiva para compatibilidad electromagnética 2004/108/EC (EMC Directive) y las enmiendas de la Unión Europea.</p> <p>Se ha realizado una "Declaración de conformidad" de acuerdo con las directivas y estándares anteriores y está archivada en Broadcom Corporation, 190 Mathilda Place, Sunnyvale, California 94086, USA.</p> <p>Unión Europea, Clase B Este dispositivo Broadcom está clasificado para ser utilizado en un entorno doméstico convencional de Clase B.</p> <p>Unión Europea, Clase A ADVERTENCIA: éste es un producto de Clase A. En un entorno doméstico, este producto puede causar interferencia de radio frecuencia, en cuyo caso el usuario debe tomar las medidas oportunas.</p>
SVENSK Swedish	<p>Denna produkt överensstämmer med EU-direktivet 2006/95/EC (lågspänningsdirektivet), 2004/108/EC (EMC direktivet), och andra ändringar enligt den Europeiska unionen.</p> <p>En "Försäkran om överensstämmelse" i enlighet med de föregående direktiven och standarderna har framställts och finns registrerad hos Broadcom Corporation, 190 Mathilda Place, Sunnyvale, California 94086, USA.</p> <p>Europeiska unionen, klass B Den här Broadcom-enheten är klassificerad för användning i vanlig klass B-bostadsmiljö.</p> <p>Europeiska unionen, klass A VARNING: Detta är en klass A-produkt. I en bostadsmiljö kan denna produkt orsaka störningar i radiofrekvenser, så att användaren får vidtaga lämpliga åtgärder.</p>
TÜRK Turkish	<p>Bu ürünün 2006/95/EC (Düşük Voltaj Direktifi), 2004/108/EC (EMC Direktifi), ve Avrupa Birliği'nin ilavelerine uygun olduğu belirlenmiştir.</p> <p>Yukarıda belirtilen direktifler ve standartlara uygun olarak, bir "Uygunluk Beyanı" hazırlanmıştır, ve Broadcom Corporation, 190 Mathilda Place, Sunnyvale, California 94086, USA.</p> <p>Avrupa Birliği, B Sınıfı Bu Broadcom cihazı, tipik bir B sınıfı, ev içi ortamda kullanılmak üzere sınıflandırılmıştır.</p> <p>Avrupa Birliği, A Sınıfı UYARI: Bu bir A sınıfı üründür. Bu ürün, mahalli bir çevrede (yada ev içinde) radyo frekans kışmasına sebep olabilir, bu durumda ise kullanıcının gerekli önlemleri alması zorunlu olabilir.</p>

Canadian Regulatory Information (Canada Only)

Industry Canada, Class B

Broadcom NetXtreme II Gigabit Ethernet Controller

- BCM95708A0804F
- BCM95709A0907G
- BCM95709A0906G

Broadcom Corporation
190 Mathilda Place
Sunnyvale, California 94086 USA

This Class B digital apparatus complies with Canadian ICES-003.

Notice: The Industry Canada regulations provide that changes or modifications not expressly approved by Broadcom could void your authority to operate this equipment.

Industry Canada, Class A

Broadcom NetXtreme II Gigabit Ethernet Controller

- BCM95709A0916G

Broadcom NetXtreme II 10 Gigabit Ethernet Controller

- BCM957710A1022G
- BCM957710A1021G
- BCM957711A1113G
- BCM957711A1102G
- BCM957810A1008G
- BCM957840A4006G

- BCM957840A4007G

Broadcom Corporation
190 Mathilda Place
Sunnyvale, California 94086 USA

This Class A digital apparatus complies with Canadian ICES-003.

Notice: The Industry Canada regulations provide that changes or modifications not expressly approved by Broadcom could void your authority to operate this equipment.

Industry Canada, classe B

Broadcom NetXtreme II Gigabit Ethernet Controller

- BCM95708A0804F
- BCM95709A0907G
- BCM95709A0906G

Broadcom Corporation
190 Mathilda Place
Sunnyvale, California 94086 USA

Cet appareil numérique de la classe B est conforme à la norme canadienne ICES-003.

Avis : Dans le cadre des réglementations d'Industry Canada, vos droits d'utilisation de cet équipement peuvent être annulés si des changements ou modifications non expressément approuvés par Broadcom y sont apportés.

Industry Canada, classe A

Broadcom NetXtreme II Gigabit Ethernet Controller

- BCM95709A0916G

Broadcom NetXtreme II 10 Gigabit Ethernet Controller

- BCM957710A1022G
- BCM957710A1021G
- BCM957711A1113G
- BCM957711A1102G
- BCM957810A1008G
- BCM957840A4006G
- BCM957840A4007G

Broadcom Corporation
190 Mathilda Place
Sunnyvale, California 94086 USA

Cet appareil numérique de classe A est conforme à la norme canadienne ICES-003.

Avis : Dans le cadre des réglementations d'Industry Canada, vos droits d'utilisation de cet équipement peuvent être annulés si des changements ou modifications non expressément approuvés par Broadcom y sont apportés.

Korea Communications Commission (KCC) Notice (Republic of Korea Only)

B Class Device

B급 기기 (가정용 방송통신기기)	이 기기는 가정용(B급)으로 전자파적합등록을 한 기기로서 주로 가정에서 사용하는 것을 목적으로 하며, 모든 지역에서 사용할 수 있습니다.
-----------------------	--

Broadcom NetXtreme II Gigabit Ethernet Controller

- BCM95708A0804F
- BCM95709A0907G
- BCM95709A0906G

Broadcom Corporation
190 Mathilda Place
Sunnyvale, California 94086 USA



1. 기기의 명칭(모델명) : BCM95708A0804F
2. 인증번호 : E-G021-05-2568(B)
3. 인증받은 자의 상호 : BROADCOM
4. 제조년월일 : 05/31/2005
5. 제조자/제조국가 : Foxconn/China



1. 기기의 명칭(모델명) : BCM95709A0907G
2. 인증번호 : BCM-BCM95709A0907G(B)
3. 인증받은 자의 상호 : BROADCOM
4. 제조년월일 : 2008/01/15
5. 제조자/제조국가 : LiteOn/CHINA



방송통신위원회

BCM-BCM95709A0906G (B)

Note that this device has been approved for non-business purposes and may be used in any environment, including residential areas.

A Class Device

A급 기기 (업무용 방송통신기기)	이 기기는 업무용(A급)으로 전자파적합등록을 한 기기이오니 판매자 또는 사용자는 이 점을 주의하시기 바라며, 가정 외의 지역에서 사용하는 것을 목적으로 합니다.
-----------------------	---

Broadcom NetXtreme II Gigabit Ethernet Controller

- BCM95709A0916G

Broadcom NetXtreme II 10 Gigabit Ethernet Controller

- BCM957710A1022G
- BCM957710A1021G

- BCM957711A1113G
- BCM957711A1102G
- BCM957810A1008G
- BCM957840A4006G
- BCM957840A4007G

Broadcom Corporation
190 Mathilda Place
Sunnyvale, California 94086 USA



1. 기기의 명칭(모델명) :BCM95709A0916G
2. 인증번호 : BCM-BCM95709A0916G(A)
3. 인증받은 자의 상호 : BROADCOM
4. 제조년월일: 2008/08/25
5. 제조자/제조국가 : LiteOn/CHINA



1. 기기의 명칭(모델명) : BCM957710A1022G
2. 인증번호 : BCM-957710A1022G (A)
3. 인증받은 자의 상호 : BROADCOM
4. 제조년월일: 2008/03/14
5. 제조자/제조국가 : LiteOn/CHINA



1. 기기의 명칭(모델명) :BCM957710A1021G
2. 인증번호 : BCM-957710A1021G (A)
3. 인증받은 자의 상호 : BROADCOM
4. 제조년월일: 2008/09/02
5. 제조자/제조국가 : LiteOn/CHINA



방송통신위원회

BCM957711A1113G (A)



방송통신위원회

BCM-957711A1102G (A)

BSMI

BSMI 通告 (僅限於台灣)

大多數的 Dell 電腦系統被 BSMI (經濟部標準檢驗局) 劃分為乙類數位裝置。但是，使用某些選件會使有些組態的等級變成甲類。若要確定您的電腦系統適用等級，請檢查所有位於電腦底部或背面板、擴充卡安裝托架，以及擴充卡上的 BSMI 註冊標籤。如果其中有一甲類標籤，即表示您的系統為甲類數位裝置。如果只有 BSMI 的檢磁號碼標籤，則表示您的系統為乙類數位裝置。

一旦確定了系統的 BSMI 等級，請閱讀相關的 BSMI 通告。請注意，BSMI 通告規定凡是未經 Dell Inc. 明確批准的擅自變更或修改，將導致您失去此設備的使用權。

此裝置符合 BSMI (經濟部標準檢驗局) 的規定，使用時須符合以下兩項條件：

- 此裝置不會產生有害干擾。
- 此裝置必須能接受所接收到的干擾，包括可能導致無法正常作業的干擾。

乙類

此設備經測試證明符合 BSMI (經濟部標準檢驗局) 之乙類數位裝置的限制規定。這些限制的目的是為了在住宅區安裝時，能防止有害的干擾，提供合理的保護。此設備會產生、使用並散發射頻能量；如果未遵照製造廠商的指導手冊來安裝和使用，可能會干擾無線電通訊。但是，這並不保證在個別的安装中不會產生干擾。您可以透過關閉和開啓此設備來判斷它是否會對廣播和電視收訊造成干擾；如果確實如此，我們建議您嘗試以下列一種或多種方法來排除干擾：

- 重新調整天線的接收方向或重新放置接收天線。
- 增加設備與接收器的距離。
- 將設備連接至不同的插座，使設備與接收器連接在不同的電路上。
- 請向經銷商或有經驗的無線電 / 電視技術人員查詢，以獲得幫助。

Certifications for BCM95709SA0908G, BCM957710A1023G, E02D001, and BCM957711A1123G (E03D001)

This section is included on behalf of Dell, and Broadcom is not responsible for the validity or accuracy of the information.

The BCM95709SA0908G Broadcom NetXtreme II Gigabit Ethernet Controller and the BCM957710A1023G, E02D001, and BCM957711A1123G (E03D001) Broadcom NetXtreme II 10 Gigabit Ethernet Controllers have received the following regulatory compliance certifications:

- FCC, Class A (USA)
- VCCI, Class A (Japan)
- CE, Class A (European Union)
- Canadian Regulatory Information, Class A (Canada)
- Korea Communications Commission (KCC) Notice (Republic of Korea)

FCC Notice

FCC, Class A

Broadcom NetXtreme II Gigabit Ethernet Controller

- BCM95709SA0908G

Broadcom NetXtreme II 10 Gigabit Ethernet Controller

- BCM957710A1023G
- BCM957711A1123G (E03D001)
- E02D001

Dell Inc.
Worldwide Regulatory Compliance, Engineering and Environmental Affairs

One Dell Way PS4-30
Round Rock, Texas 78682, USA
512-338-4400

This device complies with Part 15 of the FCC Rules. Operations is subject to the following two conditions: 1) This device may not cause harmful interference, and 2) This device must accept any interference received, including interference that may cause undesired operation.

This product has been tested and found to comply with the limits for a Class A digital device pursuant to Part 15 of the FCC Rules. These limits are designed to provide reasonable protection against harmful interference when the equipment is operated in a commercial environment. This product generates, uses, and can radiate radio frequency energy and, if not installed and used in accordance with the manufacturer's instruction manual, may cause harmful interference with radio communications. Operation of this product in a residential area is likely to cause harmful interference, in which case you will be required to correct the interference at your own expense.

These limits are designed to provide reasonable protection against harmful interference in a non-residential installation. However, there is no guarantee that interference will not occur in a particular installation. If this equipment does cause harmful interference with radio or television reception, which can be determined by turning the equipment off and on, you are encouraged to try to correct the interference by one or more of the following measures:

- Reorient the receiving antenna.
- Relocate the system with respect to the receiver.
- Move the system away from the receiver.
- Plug the system into a different outlet so that the system and receiver are on different branch circuits.

Do not make mechanical or electrical modifications to the equipment.

 NOTE: If the device is changed or modified without permission of Dell Inc., the user may void his or her authority to operate the equipment.

VCCI Notice

Class A

Broadcom NetXtreme II Gigabit Ethernet Controller

- BCM95709SA0908G

Broadcom NetXtreme II 10 Gigabit Ethernet Controller

- BCM957710A1023G
- BCM957711A1123G (E03D001)
- E02D001

Dell Inc.
Worldwide Regulatory Compliance, Engineering and Environmental Affairs
One Dell Way PS4-30
Round Rock, Texas 78682, USA
512-338-4400

This equipment is a Class A product based on the standard of the Voluntary Control Council for interference by Information Technology Equipment (VCCI). If used in a domestic environment, radio disturbance may arise. Install and use the equipment according to the instruction manual.

VCCI Class A Statement (Japan)

この装置は、情報処理装置等電波障害自主規制協議会（VCCI）の基準に基づくクラス A 情報技術装置です。この装置を家庭環境で使用すると電波障害を引き起こす可能性があります。この場合には使用者が適切な対策を講ずるよう要求されることがあります。

CE Notice

Class A

Broadcom NetXtreme II Gigabit Ethernet Controller

- BCM95709SA0908G

Broadcom NetXtreme II 10 Gigabit Ethernet Controller

- BCM957710A1023G
- BCM957711A1123G (E03D001)
- E02D001

Dell Inc.
Worldwide Regulatory Compliance, Engineering and Environmental Affairs
One Dell Way PS4-30
Round Rock, Texas 78682, USA
512-338-4400

Bulgarian	<p>Този продукт отговаря на 2006/95/EC (Нисковолтова директива), 2004/108/EC (Директива за електромагнитна съвместимост) и измененията на Европейския съюз.</p> <p>Изготвена е "Декларация за съответствие" според горепосочените директиви и стандарти, която се съхранява в Dell Inc., Worldwide Regulatory Compliance, Engineering and Environmental Affairs, One Dell Way PS4-30, Round Rock, Texas 78682, USA.</p> <p>Европейски съюз, Клас А</p> <p>ВНИМАНИЕ: Това е продукт от Клас А. В жилищна среда този продукт може да създаде радиочестотни смущения, в който случай потребителят ще трябва да вземе съответните мерки.</p>
Czech	<p>Bylo ustanoveno, že tento produkt splňuje směrnici 2006/95/EC (nízkonapěťová směrnice), směrnici 2004/108/EC (směrnice EMC) a dodatky Evropské unie.</p> <p>„Prohlášení o shodě“ v souladu s výše uvedenými směrnici a normami bylo zpracováno a je uloženo v archivu společnosti Dell Inc., Worldwide Regulatory Compliance, Engineering and Environmental Affairs, One Dell Way PS4-30, Round Rock, Texas 78682, USA.</p> <p>Evropská unie, třída A</p> <p>VAROVÁNÍ: Toto je produkt třídy A. V domácím prostředí může tento produkt způsobovat rušení rádiových frekvencí, a v takovém případě se od uživatele vyžaduje, aby učinil odpovídající opatření.</p>
Danish	<p>Dette produkt er fundet i overensstemmelse med 2006/95/EC (Lavvoltsdirektivet), 2004/108/EC (EMC-direktivet) og den Europæiske Unions ændringer.</p> <p>En "Overensstemmelseserklæring", som er i henhold til foregående direktiver og standarder, er udført og arkiveret hos Dell Inc., Worldwide Regulatory Compliance, Engineering and Environmental Affairs, One Dell Way PS4-30, Round Rock, Texas 78682, USA.</p> <p>Europæiske Union, Klasse A</p> <p>ADVARSEL: Dette er et Klasse A-produkt. I et hjemligt miljø kan dette produkt medføre forstyrrelse af radiofrekvens, og i det tilfælde må brugeren fortage passende foranstaltninger.</p>
Dutch	<p>Dit product is in overeenstemming bevonden met 2006/95/EC (Laagspanningsrichtlijn), 2004/108/EC (EMC-richtlijn) en amendementen van de Europese Unie.</p> <p>Een "Verklaring van conformiteit" in overeenstemming met de voorgenoemde richtlijnen en standaarden is beschikbaar bij Dell Inc., Worldwide Regulatory Compliance, Engineering and Environmental Affairs, One Dell Way PS4-30, Round Rock, Texas 78682, USA.</p> <p>Europese Unie/Klasse A</p> <p>VOORZICHTIG: Dit is een Klasse A-product. Binnen een woonomgeving kan dit product radiofrequente storingen veroorzaken, in welk geval de gebruiker passende maatregelen dient te nemen.</p>
English	<p>This product has been determined to be in compliance with 2006/95/EC (Low Voltage Directive), 2004/108/EC (EMC Directive), and amendments of the European Union.</p> <p>A "Declaration of Conformity" in accordance with the preceding directives and standards has been made and is on file at Dell Inc., Worldwide Regulatory Compliance, Engineering and Environmental Affairs, One Dell Way PS4-30, Round Rock, Texas 78682, USA.</p> <p>European Union, Class A</p> <p>WARNING: This is a Class A product. In a domestic environment this product may cause radio frequency interference in which case the user may be required to take adequate measures.</p>
Estonian	<p>Antud toode vastab direktiividele 2006/95/EÜ (Madalpinge direktiiv), 2004/108/EÜ (EMC direktiiv) ja ELi parandustele.</p> <p>Vastavalt ülaltoodud direktiividele ja standarditele on koostatud „Vastavusdeklaratsioon“, mis on arvel ettevõttes Dell Inc., Worldwide Regulatory Compliance, Engineering and Environmental Affairs, One Dell Way PS4-30, Round Rock, Texas 78682, USA.</p> <p>Euroopa Liit, Klass A</p> <p>HOIATUS See on A-klassi toode. Koduses keskkonnas võib antud toode põhjustada raadiosageduslikke häireid, mille korral kasutaja peab võtma vastavad meetmed.</p>
Finnish	<p>Tämä tuote täyttää Euroopan unionin direktiivin 2006/95/EY (pienjännitedirektiivi) ja direktiivin 2004/108/EY (sähkömagneettisesta yhteensopivuudesta annettu direktiivi), sellaisina kuin ne ovat muutettuina, vaatimukset.</p> <p>Yllä mainittujen direktiivien ja standardien mukainen vaatimustenmukaisuusvakuutus on tehty, ja sitä säilyttää Dell Inc., Worldwide Regulatory Compliance, Engineering and Environmental Affairs, One Dell Way PS4-30, Round Rock, Texas 78682, USA.</p> <p>Euroopan unioni, Luokka A</p> <p>VAROITUS: Tämä on Luokan A tuote. Asuinympäristössä tämä laite saattaa aiheuttaa radiotaajuushäiriöitä, mikä saattaa edellyttää toimia laitteen käyttäjältä.</p>

French	<p>Ce produit a été déclaré conforme aux directives 2006/95/EC (Directive sur la faible tension), 2004/108/EC (Directive EMC) et aux amendements de l'Union européenne.</p> <p>Une « Déclaration de Conformité » relative aux normes et directives précédentes a été rédigée et est enregistrée auprès de Dell Inc., Worldwide Regulatory Compliance, Engineering and Environmental Affairs, One Dell Way PS4-30, Round Rock, Texas 78682, USA.</p> <p>Union européenne, classe A</p> <p>AVERTISSEMENT : Ce produit est un produit de classe A. Dans un environnement résidentiel, ce produit peut provoquer des perturbations radioélectriques, auquel cas l'utilisateur peut se voir obligé de prendre les mesures appropriées.</p>
German	<p>Es ist befunden worden, dass dieses Produkt in Übereinstimmung mit 2006/95/EC (Niederspannungs-Richtlinie), 2004/108/EC (EMV-Richtlinie) und Ergänzungen der Europäischen Union steht.</p> <p>Eine Konformitätserklärung in Übereinstimmung mit den oben angeführten Normen ist abgegeben worden und kann bei Dell Inc., Worldwide Regulatory Compliance, Engineering and Environmental Affairs, One Dell Way PS4-30, Round Rock, Texas 78682, USA.</p> <p>Europäische Union, Klasse A</p> <p>WARNUNG: Dies ist ein Produkt der Klasse A. In einer häuslichen Umgebung kann dieses Produkt Hochfrequenzstörungen verursachen. In diesem Fall muss der Benutzer die entsprechenden Maßnahmen treffen.</p>
Greek	<p>Το προϊόν αυτό συμμορφώνεται με τις οδηγίες 2006/95/ΕΕ (Οδηγία περί χαμηλής τάσης), 2004/108/ΕΕ (Οδηγία περί ηλεκτρομαγνητικής συμβατότητας), και τροποποιήσεις τους από την Ευρωπαϊκή Ένωση.</p> <p>Μία «Δήλωση Συμμόρφωσης» σύμφωνα με τις προηγούμενες οδηγίες και πρότυπα υπάρχει και είναι αρχειοθετημένη στο Dell Inc., Worldwide Regulatory Compliance, Engineering and Environmental Affairs, One Dell Way PS4-30, Round Rock, Texas 78682, USA.</p> <p>Ευρωπαϊκή Ένωση, Κατηγορία Α</p> <p>ΠΡΟΕΙΔΟΠΟΙΗΣΗ: Αυτό είναι ένα προϊόν κατηγορίας Α. Σε οικιακό περιβάλλον, αυτό το προϊόν μπορεί να προκαλέσει παρεμβολές ραδιοσυχνότητας (RF), στην οποία περίπτωση μπορεί να απαιτηθεί η λήψη κατάλληλων μέτρων από τον χρήστη.</p>
Hungarian	<p>A termék megfelel a 2006/95/EGK (alacsony feszültségű eszközökre vonatkozó irányelv), a 2004/108/EGK (EMC irányelv) és az Európai Unió ajánlásainak.</p> <p>Az előbbiekben ismertetett irányelvek és szabványok szellemében „Megfelelőségi nyilatkozat” készült, amely az irországi Dell Inc., Worldwide Regulatory Compliance, Engineering and Environmental Affairs, One Dell Way PS4-30, Round Rock, Texas 78682, USA.</p> <p>Európai Unió, „A” osztály</p> <p>FIGYELEM! „A” osztályba sorolt termék. Lakóhelyi környezetben ez a termék rádiófrekvenciás (RF) interferenciát okozhat, ebben az esetben a felhasználónak gondoskodnia kell a szükséges ellenintézkedésekről.</p>
Iberian Portuguese	<p>Este produto deve estar em conformidade com 2006/95/EC (Directiva de baixa tensão), com 2004/108/EC (Directiva de compatibilidade electromagnética) e com as alterações da União Europeia.</p> <p>Foi elaborada uma "Declaração de Conformidade" de acordo com as directivas e padrões precedentes e encontra-se arquivada na Dell Inc., Worldwide Regulatory Compliance, Engineering and Environmental Affairs, One Dell Way PS4-30, Round Rock, Texas 78682, USA.</p> <p>União Europeia, Classe A</p> <p>ADVERTÊNCIA: Este é um produto Classe A. Num ambiente doméstico, este produto pode provocar interferências de frequência de rádio, podendo ser necessário que o utilizador adopte as medidas adequadas.</p>
Italian	<p>Il presente prodotto è stato determinato essere conforme alla 2006/95/CE (Direttiva Bassa Tensione), alla 2004/108/CE (Direttiva CEM) e a rettifiche da parte dell'Unione Europea.</p> <p>Una "Dichiarazione di conformità" secondo gli standard e le direttive precedenti è stata emessa e registrata presso Dell Inc., Worldwide Regulatory Compliance, Engineering and Environmental Affairs, One Dell Way PS4-30, Round Rock, Texas 78682, USA.</p> <p>Unione Europea, Classe A</p> <p>AVVERTENZA: Questo prodotto è classificato come Classe A. In un ambiente domestico il presente prodotto potrebbe provocare interferenze di radiofrequenza, nel qual caso potrebbe essere richiesto all'utente di adottare misure adeguate.</p>

Latvian	<p>Šis izstrādājums atbilst direktīvām 2006/95/EK (Direktīva par zemsprieguma iekārtām), 2004/108/EK (Direktīva par elektromagnētisko saderību) un to labojumiem Eiropas Savienības ietvaros.</p> <p>“Atbilstības deklarācija”, kas ir saskaņā ar iepriekšminētajām direktīvām un standartiem, ir sastādīta un tiek glabāta firmā Dell Inc., Worldwide Regulatory Compliance, Engineering and Environmental Affairs, One Dell Way PS4-30, Round Rock, Texas 78682, USA.</p> <p>Eiropas Savienība, A klase BRĪDINĀJUMS. Šis A klases izstrādājums. Izmantojot šo izstrādājumu mājās apstākļos, tas var radīt radiotraucējumus; šajā gadījumā lietotājam var būt nepieciešams veikt atbilstošus pasākumus.</p>
Lithuanian	<p>Buvo nustatyta, kad šis produktas atitinka direktyvą 73/23/EEB (žemos įtampos direktyvą), 89/336/EEB (elektromagnetinio suderinamumo direktyvą) ir Europos Sąjungos pataisas.</p> <p>Atitikties deklaracija pagal visas galiojančias direktyvas ir standartus yra sudaryta ir saugoma įrašyta faile Dell Inc., Worldwide Regulatory Compliance, Engineering and Environmental Affairs, One Dell Way PS4-30, Round Rock, Texas 78682, USA.</p> <p>Eiropos Sąjunga, A klasė ĮSPĖJIMAS. Tai yra A klasės produktas. Gyvenamosiose aplinkose šis produktas gali kelti radijo dažnių trikdžius. Tokiu atveju naudotojui gali reikėti imtis atitinkamų priemonių.</p>
Maltese	<p>Gie stabbilit li dan il-prodott hu konformi ma' 2006/95/KE (Direttiva dwar il-Vultaġġ Baxx), 2004/108/KE (Direttiva EMC), u emendi ta' l-Unjoni Ewropea.</p> <p>Saret “Dikjarazzjoni ta’ Konformità” b’konformità mad-direttivi u ma’ l-istandards imsemmijin qabel, u din tinsab iffajljata għand Dell Inc., Worldwide Regulatory Compliance, Engineering and Environmental Affairs, One Dell Way PS4-30, Round Rock, Texas 78682, USA.</p> <p>Unjoni Ewropea, Klassi A TWISSIJA: Dan huwa prodott ta’ Klassi A. F’ambjent domestiku dan il-prodott jista’ jikkawza interferenza tal-frekwenza tar-radju (RF), f’liema każ l-utent jista’ jkun mehtieg li jiehu miżuri adegwati.</p>
Polish	<p>Niniejszy produkt został określony jako zgodny z dyrektywą niskonapięciową 2006/95/WE i dyrektywą zgodności elektromagnetycznej 2004/108/WE oraz poprawkami do nich.</p> <p>Zgodnie ze stosownymi dyrektywami i normami została sporządzona „Deklaracja zgodności”, która jest dostępna w aktach firmy Dell Inc., Worldwide Regulatory Compliance, Engineering and Environmental Affairs, One Dell Way PS4-30, Round Rock, Texas 78682, USA.</p> <p>Unia Europejska, klasa A OSTRZEŻENIE: Urządzenie to jest urządzeniem klasy A. W warunkach domowych urządzenie to może wywoływać zakłócenia o częstotliwości radiowej, wymagające od użytkownika podjęcia odpowiednich działań zaradczych.</p>
Romanian	<p>S-a stabilit că acest produs respectă cerințele Directivei 2006/95/CE privind echipamentele de joasă tensiune, ale Directivei 2004/108/CE (Directiva EMC) privind compatibilitatea electromagnetică și ale amendamentelor Uniunii Europene.</p> <p>Conform directivelor și standardelor de mai sus, a fost emisă o „Declaratie de Conformitate”, arhivată la sediul Dell Inc., Worldwide Regulatory Compliance, Engineering and Environmental Affairs, One Dell Way PS4-30, Round Rock, Texas 78682, USA.</p> <p>Uniunea Europeană, Clasa A AVERTISMENT: Acesta este un produs din Clasa A. În mediul casnic, acest produs poate cauza interferențe radio, caz în care utilizatorul trebuie să ia măsurile necesare.</p>
Slovakian	<p>Tento výrobok vyhovuje požiadavkám smernice 2006/95/EC (smernica o nízkom napätí), 2004/108/EC (smernica o elektromagnetickej kompatibilite) a neskorším zmenám a doplnkom Európskej.</p> <p>„Vyhlásenie o zhode” vydané v súlade s prechádzajúcimi smernicami a štandardmi sa nachádza v spoločnosti Dell Inc., Worldwide Regulatory Compliance, Engineering and Environmental Affairs, One Dell Way PS4-30, Round Rock, Texas 78682, USA.</p> <p>Európska únia, Trieda A VAROVANIE: Toto je zariadenie triedy A. V domácom prostredí môže tento produkt spôsobovať rušenie rádiovkej frekvencie. V takom prípade musí používateľ prijať príslušné opatrenia.</p>

Slovenian	<p>Ta izdelek je v skladu z 2006/95/ES (Direktiva o nizki napetosti), 2004/108/ES (Direktiva o elektromagnetni združljivosti) in dopolnili Evropske unije.</p> <p>«Izjava o skladnosti» je bila sprejeta v skladu s predhodnimi direktivami in standardi in je shranjena na naslovu Dell Inc., Worldwide Regulatory Compliance, Engineering and Environmental Affairs, One Dell Way PS4-30, Round Rock, Texas 78682, USA.</p> <p>Evropska unija, razred A</p> <p>OPOZORILO: To je izdelek razreda A. V domačem okolju lahko ta izdelek povzroča motnje radijskih frekvenc, v tem primeru mora uporabnik ustrezno ukrepati.</p>
Spanish	<p>Este producto se ha fabricado de conformidad con la Directiva para bajo voltaje 2006/95/EC (Low Voltage Directive), la Directiva para compatibilidad electromagnética 2004/108/EC (EMC Directive) y las enmiendas de la Unión Europea.</p> <p>Se ha realizado una "Declaración de conformidad" de acuerdo con las directivas y estándares anteriores y está archivada en Dell Inc., Worldwide Regulatory Compliance, Engineering and Environmental Affairs, One Dell Way PS4-30, Round Rock, Texas 78682, USA.</p> <p>Unión Europea, Clase A</p> <p>ADVERTENCIA: éste es un producto de Clase A. En un entorno doméstico, este producto puede causar interferencia de radio frecuencia, en cuyo caso el usuario debe tomar las medidas oportunas.</p>
Swedish	<p>Denna produkt överensstämmer med EU-direktivet 2006/95/EC (lågspänningsdirektivet), 2004/108/EC (EMC direktivet), och andra ändringar enligt den Europeiska unionen.</p> <p>En "Försäkran om överensstämmelse" i enlighet med de föregående direktiven och standarderna har framställts och finns registrerad hos Dell Inc., Worldwide Regulatory Compliance, Engineering and Environmental Affairs, One Dell Way PS4-30, Round Rock, Texas 78682, USA.</p> <p>Europeiska unionen, klass A</p> <p>VARNING: Detta är en klass A-produkt. I en bostadsmiljö kan denna produkt orsaka störningar i radiofrekvenser, så att användaren får vidtaga lämpliga åtgärder.</p>
Turkish	<p>Bu ürünün 2006/95/EC (Düşük Voltaj Direktifi), 2004/108/EC (EMC Direktifi), ve Avrupa Birliği'nin ilavelerine uygun olduğu belirlenmiştir.</p> <p>Yukarıda belirtilen direktifler ve standartlara uygun olarak, bir "Uygunluk Beyanı" hazırlanmıştır ve Dell Inc., Worldwide Regulatory Compliance, Engineering and Environmental Affairs, One Dell Way PS4-30, Round Rock, Texas 78682, USA.</p> <p>Avrupa Birliği, A Sınıfı</p> <p>UYARI: Bu bir A sınıfı üründür. Bu ürün, mahalli bir çevrede (yada ev içinde) radyo frekans karışmasına sebep olabilir, bu durumda ise kullanıcının gerekli önlemleri alması zorunlu olabilir.</p>

Canadian Regulatory Information (Canada Only)

Industry Canada, Class A

Broadcom NetXtreme II Gigabit Ethernet Controller

- BCM95709SA0908G

Broadcom NetXtreme II 10 Gigabit Ethernet Controller

- BCM957710A1023G
- BCM957711A1123G (E03D001)
- E02D001

Dell Inc.
Worldwide Regulatory Compliance, Engineering and Environmental Affairs
One Dell Way PS4-30
Round Rock, Texas 78682, USA
512-338-4400

This Class A digital apparatus complies with Canadian ICES-003.

Notice: The Industry Canada regulations provide that changes or modifications not expressly approved by Dell Inc. could void your authority to operate this equipment.

Industry Canada, classe A

Broadcom NetXtreme II Gigabit Ethernet Controller

- BCM95709SA0908G

Broadcom NetXtreme II 10 Gigabit Ethernet Controller

- BCM957710A1023G

- BCM957711A1123G (E03D001)
- E02D001

Dell Inc.
 Worldwide Regulatory Compliance, Engineering and Environmental Affairs
 One Dell Way PS4-30
 Round Rock, Texas 78682, USA
 512-338-4400

Cet appareil numérique de classe A est conforme à la norme canadienne ICES-003.

Avis : Dans le cadre des réglementations d'Industry Canada, vos droits d'utilisation de cet équipement peuvent être annulés si des changements ou modifications non expressément approuvés par Dell Inc. y sont apportés.

Korea Communications Commission (KCC) Notice (Republic of Korea Only)

A Class Device

A급 기기 (업무용 방송통신기기)	이 기기는 업무용(A급)으로 전자파적합등록을 한 기기이오니 판매자 또는 사용자는 이 점을 주의하시기 바라며, 가정 외의 지역에서 사용하는 것을 목적으로 합니다.
-----------------------	---

Broadcom NetXtreme II Gigabit Ethernet Controller

- BCM95709SA0908G (5709s-mezz)

Broadcom NetXtreme II 10 Gigabit Ethernet Controller

- BCM957710A1023G
- BCM957711A1123G (E03D001)
- E02D001

Dell Inc.
 Worldwide Regulatory Compliance, Engineering and Environmental Affairs
 One Dell Way PS4-30
 Round Rock, Texas 78682, USA
 512-338-4400



1. 기기의 명칭(모델명) : 5709s-mezz
2. 인증번호 : E2K-5709s-mezz(A)
3. 인증받은 자의 상호 : DELL INC.
4. 제조년월일: 2008/08/12
5. 제조자/제조국가 : LiteOn/CHINA



1. 기기의 명칭(모델명) : BCM957710A1023G
2. 인증번호 : E2K-957710A1023G (A)
3. 인증받은 자의 상호 : DELL INC.
4. 제조년월일: 2008/10/15
5. 제조자/제조국가 : LiteOn/CHINA



방송통신위원회
E2K-E03D001 (A)



방송통신위원회
E2K-E02D001 (A)

End of Dell-provided certification information. The remainder of this document conforms to the general [Restrictions and Disclaimers](#) listed at the beginning of this user guide.

Please read all [Restrictions and Disclaimers](#).

[Back to Contents Page](#)

[Back to Contents Page](#)

Troubleshooting: Broadcom NetXtreme II® Network Adapter User Guide

- [Hardware Diagnostics](#)
- [Checking Port LEDs](#)
- [Troubleshooting Checklist](#)
- [Checking if Current Drivers are Loaded](#)
- [Running a Cable Length Test](#)
- [Testing Network Connectivity](#)
- [Microsoft Virtualization with Hyper-V](#)
- [Removing the Broadcom NetXtreme II Device Drivers](#)
- [Upgrading Windows Operating Systems](#)
- [Broadcom Boot Agent](#)
- [Broadcom Advanced Server Program \(BASP\)](#)
- [Linux](#)
- [NPAR](#)
- [Kernel Debugging over Ethernet](#)
- [Miscellaneous](#)

Hardware Diagnostics

Loopback diagnostic tests are available for testing the adapter hardware. These tests provide access to the adapter internal/external diagnostics, where packet information is transmitted across the physical link (for instructions and information on running tests in an MS-DOS environment, see [User Diagnostics](#); for Windows environments, see [Running Diagnostic Tests in Windows](#)).

BACS Diagnostic Tests Failures

If any of the following tests fail while running the diagnostic tests from BACS, this may indicate a hardware issue with the NIC or LOM that is installed in the system.

- Control Registers
- MII Registers
- EEPROM
- Internal Memory
- On-Chip CPU
- Interrupt
- Loopback - MAC
- Loopback - PHY
- Test LED

Below are troubleshooting steps that may help correct the failure.

1. Remove the failing device and reseal it in the slot, ensuring the card is firmly seated in the slot from front to back.
2. Rerun the test.

3. If the card still fails, replace it with a different card of the same model and run the test. If the test passes on the known good card, contact your hardware vendor for assistance on the failing device.
4. Power down the machine, remove AC power from the machine, and then reboot the system.
5. Remove and re-install the diagnostic software.
6. Contact your hardware vendor.

BACS Network Test Failures

Typically, the BACS [Testing the Network](#) failures are the result of a configuration problem on the network or with the IP addresses. Below are common steps to perform when troubleshooting the network.

1. Verify that the cable is attached and you have proper link.
2. Verify that the drivers are loaded and enabled.
3. Replace the cable that is attached to the NIC/LOM.
4. Verify that the IP address is assigned correctly using the command "ipconfig" or by checking the OS IP assigning tool.
5. Verify that the IP address is correct for the network to which the adapter(s) is connected.

Checking Port LEDs

See [Network Link and Activity Indication](#) to check the state of the network link and activity.

Troubleshooting Checklist

 **CAUTION!** Before you open the cabinet of your server to add or remove the adapter, review [Safety Precautions](#).

The following checklist provides recommended actions to take to resolve problems installing the Broadcom NetXtreme II adapter or running it in your system.

- Inspect all cables and connections. Verify that the cable connections at the network adapter and the switch are attached properly. Verify that the cable length and rating comply with the requirements listed in [Connecting the Network Cables](#).
- Check the adapter installation by reviewing [Installation of the Add-In NIC](#). Verify that the adapter is properly seated in the slot. Check for specific hardware problems, such as obvious damage to board components or the PCI edge connector.
- Check the configuration settings and change them if they are in conflict with another device.
- Verify that your server is using the latest BIOS.
- Try inserting the adapter in another slot. If the new position works, the original slot in your system may be defective.
- Replace the failed adapter with one that is known to work properly. If the second adapter works in the slot where the first one failed, the original adapter is probably defective.
- Install the adapter in another functioning system and run the tests again. If the adapter passed the tests in the new system, the original system may be defective.
- Remove all other adapters from the system and run the tests again. If the adapter passes the tests, the other adapters may be causing contention.

Checking if Current Drivers are Loaded

Windows

See [Viewing Vital Signs](#) to view vital information about the adapter, link status, and network connectivity.

Linux

To verify that the bnx2.o driver is loaded properly, run:

```
lsmod | grep -i <module name>
```

If the driver is loaded, the output of this command shows the size of the driver in bytes and the number of adapters configured and their names. The following example shows the drivers loaded for the bnx2 module:

```
[root@test1]# lsmod | grep -i bnx2
bnx2          199238  0
bnx2fc       133775  0
libfcoe      39764   2  bnx2fc,fcoe
libfc        108727  3  bnx2fc,fcoe,libfcoe
scsi_transport_fc 55235  3  bnx2fc,fcoe,libfc
bnx2i        53488  11
cnic         86401   6  bnx2fc,bnx2i
libiscsi     47617   8  be2iscsi,bnx2i,cxgb4i,cxgb3i,libcxgbi,ib_iser,iscsi_tcp,libiscsi_tcp
scsi_transport_iscsi 53047  8  be2iscsi,bnx2i,libcxgbi,ib_iser,iscsi_tcp,libiscsi
bnx2x       1417947  0
libcrc32c   1246    1  bnx2x
mdio        4732    2  cxgb3,bnx2x
```

If you reboot after loading a new driver, you can use the following command to verify that the currently loaded driver is the correct version.

```
modinfo bnx2
```

```
[root@test1]# lsmod | grep -i bnx2
```

```
bnx2 199238 0
```

Or, you can use the following command:

```
[root@test1]# ethtool -i eth2
driver: bnx2x
version: 1.78.07
firmware-version: bc 7.8.6
bus-info: 0000:04:00.2
```

If you loaded a new driver but have not yet booted, the `modinfo` command will not show the updated driver information. Instead, you can view the logs to verify that the proper driver is loaded and will be active upon reboot:

```
dmesg | grep -i "Broadcom" | grep -i "bnx2"
```

Running a Cable Length Test

For Windows operating systems, see [Analyzing Cables in Windows](#) for information on running a cable length test. Cable analysis is not available for NetXtreme II 10 GbE network adapters.

Testing Network Connectivity

 **NOTE:** When using forced link speeds, verify that both the adapter and the switch are forced to the same speed.

Windows

Network connectivity can be tested using the [Testing the Network](#) feature in Broadcom Advanced Control Suite.

An alternate method is to use the ping command to determine if the network connection is working.

1. Click **Start**, and then click **Run**.
2. Type `cmd` in the **Open** box, and then click **OK**.
3. Type `ipconfig /all` to view the network connection to be tested.
4. Type `ping IP address`, and then press **ENTER**.

The ping statistics that are displayed indicate whether the network connection is working or not.

Linux

To verify that the Ethernet interface is up and running, run `ifconfig` to check the status of the Ethernet interface. It is possible to use `netstat -i` to check the statistics on the Ethernet interface. See [Linux Driver Software](#) for information on `ifconfig` and `netstat`.

Ping an IP host on the network to verify connection has been established.

From the command line, type `ping IP address`, and then press **ENTER**.

The ping statistics that are displayed indicate whether or not the network connection is working.

Microsoft Virtualization with Hyper-V

Microsoft Virtualization is a hypervisor virtualization system for Windows Server 2008 and Windows Server 2008 R2. This section is intended for those who are familiar with Hyper-V, and it addresses issues that affect the configuration of NetXtreme II network adapters and teamed network adapters when Hyper-V is used. For more information on Hyper-V, see <http://www.microsoft.com/windowsserver2008/en/us/hyperv.aspx>.

Table 1 identifies Hyper-V supported features that are configurable for NetXtreme II network adapters. This table is not an all-inclusive list of Hyper-V features.

Table 1: Configurable Network Adapter Hyper-V Features

Feature	Supported in Windows Server			Comments/Limitation
	2008	2008 R2	2012	
IPv4	Yes	Yes	Yes	–
IPv6	Yes	Yes	Yes	–
IPv4 Large Send Offload (LSO) (parent and child partition)	Yes	Yes	Yes	–
IPv4 Checksum Offload (CO) (parent and child partition)	Yes	Yes	Yes	–
IPv4 TCP Offload Engine (TOE)	No*	No*	No*	*OS limitation.
IPv6 LSO (parent and child partition)	No*	Yes	Yes	*When bound to a virtual network, OS limitation.
IPv6 CO (parent and child partition)	No*	Yes	Yes	*When bound to a virtual network, OS limitation.
IPv6 TOE	No	No	No	OS limitation.
Jumbo frames	No*	Yes	Yes	*OS limitation.
RSS	No*	No*	Yes	*OS limitation.
RSC	No*	No*	Yes	*OS limitation.
SRIOV	No*	No*	Yes	*OS limitation.

 **NOTE:** Ensure that Integrated Services, which is a component of Hyper-V, is installed in the guest operating system (child partition) for full functionality.

Single Network Adapter

Windows Server 2008

When configuring a NetXtreme II network adapter on a Hyper-V system, be aware of the following:

- An adapter that is to be bound to a virtual network should not be configured for VLAN tagging through the driver's advanced properties. Instead, Hyper-V should manage VLAN tagging exclusively.
- Since Hyper-V does not support Jumbo Frames, it is recommended that this feature not be used or connectivity issues may occur with the child partition.
- The Locally Administered Address (LAA) set by Hyper-V takes precedence over the address set in the adapter's advanced properties.
- A TOE-enabled network adapter that is bound to a Hyper-V virtual network will report TOE as an offload capability in BACS; however, TOE will not work. This is a limitation of Hyper-V. Hyper-V does not support TOE.
- In an IPv6 network, a team that supports CO and/or LSO and is bound to a Hyper-V virtual network will report CO and LSO as an offload capability in BACS; however, CO and LSO will not work. This is a limitation of Hyper-V. Hyper-V does not support CO and LSO in an IPv6 network.

Windows Server 2008 R2 and 2012

When configuring a NetXtreme II network adapter on a Hyper-V system, be aware of the following:

- An adapter that is to be bound to a virtual network should not be configured for VLAN tagging through the driver's advanced properties. Instead, Hyper-V should manage VLAN tagging exclusively.
- The Locally Administered Address (LAA) set by Hyper-V takes precedence over the address set in the adapter's advanced properties.
- The LSO and CO features in the guest OS are independent of the network adapter properties.
- To allow jumbo frame functionality from the guest OS, both the network adapter and the virtual adapter must have jumbo frames enabled. The Jumbo MTU property for the network adapter must be set to allow traffic of large MTU from within the guest OS. The jumbo packet of the virtual adapter must be set in order to segment the sent and received packets.

Teamed Network Adapters

[Table 2](#) identifies Hyper-V supported features that are configurable for NetXtreme II teamed network adapters. This table is not an all-inclusive list of Hyper-V features.

Table 2: Configurable Teamed Network Adapter Hyper-V Features

Feature	Supported in Windows Server Version			Comments/Limitation
	2008	2008 R2	2012	
Smart Load Balancing and Failover (SLB) team type	Yes	Yes	Yes	Multi-member SLB team allowed with latest BASP6 version. Note: VM MAC is not presented to external switches.
Link Aggregation (IEEE 802.3ad LACP) team type	Yes	Yes	Yes	–
Generic Trunking (FEC/GEC) 802.3ad Draft Static team type	Yes	Yes	Yes	–
Failover	Yes	Yes	Yes	–
LiveLink	Yes	Yes	Yes	–
Large Send Offload (LSO)	Limited*	Yes	Yes	*Conforms to miniport limitations outlines in Table 1 .
Checksum Offload (CO)	Limited*	Yes	Yes	*Conforms to miniport limitations outlines in Table 1 .
TCP Offload Engine (TOE)	No	No	No	
Hyper-V VLAN over an adapter	Yes	Yes	Yes	–
Hyper-V VLAN over a teamed adapter	Yes	Yes	Yes	–
Hyper-V VLAN over a VLAN	Limited*	Limited*	Limited*	Only an untagged VLAN.
Hyper-V virtual switch over an adapter	Yes	Yes	Yes	–
Hyper-V virtual switch over a teamed adapter	Yes	Yes	Yes	–
Hyper-V virtual switch over a VLAN	Yes	Yes	Yes	–
iSCSI boot	No	No*	No*	*Remote boot to SAN is supported.
Virtual Machine Queue (VMQ)	No	Yes	Yes	See Configuring VMQ with SLB Teaming .
RSC	No	No	Yes	

Windows Server 2008

When configuring a team of NetXtreme II network adapters on a Hyper-V system, be aware of the following:

- Create the team prior to binding the team to the Hyper-V virtual network.
- Create a team only with an adapter that is not already assigned to a Hyper-V virtual network.

- A TOE-enabled team that is bound to a Hyper-V virtual network will report TOE as an offload capability in BACS; however, TOE will not work. This is a limitation of Hyper-V. Hyper-V does not support TOE.
- In an IPv6 network, a team that supports CO and/or LSO and is bound to a Hyper-V virtual network will report CO and LSO as an offload capability in BACS; however, CO and LSO will not work. This is a limitation of Hyper-V. Hyper-V does not support CO and LSO in an IPv6 network.
- To successfully perform VLAN tagging for both the host (parent partition) and the guest (child partition) with the BASP teaming software, you must configure the team for tagging. Unlike VLAN tagging with a single adapter, tagging cannot be managed by Hyper-V when using BASP software.
- When making changes to a team or removing a team, remove the team's binding from all guest OSs that use any of the VNICs in the team, change the configuration, and then rebind the team's VNICs to the guest OS. This can be done in the Hyper-V Manager.

Windows Server 2008 R2

When configuring a team of NetXtreme II network adapters on a Hyper-V system, be aware of the following:

- Create the team prior to binding the team to the Hyper-V virtual network.
- Create a team only with an adapter that is not already assigned to a Hyper-V virtual network.
- A BASP virtual adapter configured for VLAN tagging can be bound to a Hyper-V virtual network, and is a supported configuration. However, the VLAN tagging capability of BASP cannot be combined with the VLAN capability of Hyper-V. In order to use the VLAN capability of Hyper-V, the BASP team must be untagged.
- When making changes to a team or removing a team, remove the team's binding from all guest OSs that use any of the VNICs in the team, change the configuration, and then rebind the team's VNICs to the guest OS. This can be done in the Hyper-V Manager.

Configuring VMQ with SLB Teaming

When Hyper-V server is installed on a system configured to use Smart Load Balance and Failover (SLB) type teaming, you can enable Virtual Machine Queueing (VMQ) to improve overall network performance. VMQ enables delivering packets from an external virtual network directly to virtual machines defined in the SLB team, eliminating the need to route these packets and, thereby, reducing overhead.

To create a VMQ-capable SLB team:

1. Create an SLB team. If using the Teaming Wizard, when you select the SLB team type, also select **Enable HyperV Mode**. If using Expert mode, enable the property in the Create Team or Edit Team tabs. See [Configuring Teaming](#) for additional instructions on creating a team.
2. Follow these instructions to add the required registry entries in Windows:

<http://technet.microsoft.com/en-us/library/gg162696%28v=ws.10%29.aspx>

3. For each team member on which you want to enable VMQ, modify the following registry entry and configure a unique instance number (in the following example, it is set to 0026):

```
[HKEY_LOCAL_MACHINE\SYSTEM\CurrentControlSet\Control\Class\
  {4D36E972-E325-11CE-BFC1-08002BE10318}\0026]
```

```
"*RssOrVmqPreference"="1"
```

Removing the Broadcom NetXtreme II Device Drivers

Uninstall the Broadcom NetXtreme II device drivers from your system only through the InstallShield wizard. Uninstalling the device drivers with Device Manager or any other means may not provide a clean uninstall and may cause the system to become unstable. For information on uninstalling Broadcom NetXtreme II device drivers, see [Removing the Device Drivers](#). When removing the device drivers, Broadcom Advanced Control Suite is also removed as well as all other management applications.

If you manually uninstalled the device drivers with Device Manager and attempted to reinstall the device drivers but could not, run the Repair option from the InstallShield wizard. For information on repairing Broadcom NetXtreme II device drivers, see [Repairing or Reinstalling the Driver Software](#).

Upgrading Windows Operating Systems

This section covers Windows upgrades for the following:

- From Windows Server 2003 to Windows Server 2008
- From Windows Server 2008 to Windows Server 2008 R2
- From Windows Server 2008 R2 to Windows Server 2012

Prior to performing an OS upgrade when a Broadcom NetXtreme II adapter is installed on your system, Broadcom recommends the procedure below.

1. Save all team and adapter IP information.
2. Uninstall all Broadcom drivers using the installer.
3. Perform the Windows upgrade.
4. Reinstall the latest Broadcom adapter drivers and the BACS application.

Broadcom Boot Agent

Problem: Unable to obtain network settings through DHCP using PXE.

Solution: For proper operation make sure that the Spanning Tree Protocol (STP) is disabled or that portfast mode (for Cisco) is enabled on the port to which the PXE client is connected. For instance, set spantree portfast 4/12 enable.

Broadcom Advanced Server Program (BASP)

Problem: After physically removing a NIC that was part of a team and then rebooting, the team did not perform as expected.

Solution: To physically remove a teamed NIC from a system, you must first delete the NIC from the team. Not doing this before shutting down could result in breaking the team on a subsequent reboot, which may result in unexpected team behavior.

Problem: After deleting a team that uses IPv6 addresses and then re-creating the team, the IPv6 addresses from the old team are used for the re-created team.

Solution: This is a third-party issue. To remove the old team's IPv6 addresses, locate the General tab for the team's TCP/IP properties from your system's Network Connections. Either delete the old addresses and type in new IPv6 addresses or select the option to automatically obtain IP addresses.

Problem: Adding an NLB-enabled NetXtreme II adapter to a team may cause unpredictable results.

Solution: Prior to creating the team, unbind NLB from the NetXtreme II adapter, create the team, and then bind NLB to the team.

Problem: A system containing an 802.3ad team causes a Netlogon service failure in the system event log and prevents it from communicating with the domain controller during boot up.

Solution: Microsoft Knowledge Base Article 326152 (<http://support.microsoft.com/kb/326152/en-us>) indicates that Gigabit Ethernet adapters may experience problems with connectivity to a domain controller due to link fluctuation while the driver initializes and negotiates link with the network infrastructure. The link negotiation is further affected when the Gigabit adapters are participating in an 802.3ad team due to the additional negotiation with a switch required for this team type. As suggested in the Knowledge Base Article above, disabling media sense as described in a separate Knowledge Base Article 938449 (<http://support.microsoft.com/kb/938449>) has shown to be a valid workaround when this problem occurs.

Problem: The 802.3ad team member links disconnect and reconnect continuously (applies to all operating systems).

Solution: This is a third-party issue. It is seen only when configuring an 802.3ad team with greater than two members on the server and connecting an HP2524 switch, with LACP enabled as passive or active. The HP switch shows an LACP channel being brought up successfully with only two team members. All other team member links disconnect and reconnect. This does not occur with a Cisco Catalyst 6500.

Problem: A Generic Trunking (GEC/FEC) 802.3ad-Draft Static type of team may lose some network connectivity if the driver to a team member is disabled.

Solution: If a team member supports underlying management software (ASF/UMP) or Wake-On-LAN, the link may be maintained on the switch for the adapter despite its driver being disabled. This may result in the switch continuing to pass traffic to the attached port rather than route the traffic to an active team member port. Disconnecting the disabled adapter from the switch will allow traffic to resume to the other active team members.

Problem: Large Send Offload (LSO) and Checksum Offload are not working on my team.

Solution: If one of the adapters on a team does not support LSO, LSO does not function for the team. Remove the adapter that does not support LSO from the team, or replace it with one that does. The same applies to Checksum Offload.

Problem: The advanced properties of a team do not change after changing the advanced properties of an adapter that is a member of the team.

Solution: If an adapter is included as a member of a team and you change any advanced property, then you must rebuild the team to ensure that the team's advanced properties are properly set.

Problem: The TOE offload capabilities of a team do not change after removing the TOE key from an adapter that is a member of the team.

Solution: If an adapter with a TOE key is included as a member of a team and you remove the TOE key, then you must rebuild the team to ensure that the team does not appear to be TOE-enabled.

Linux

Problem: BCM5771x devices with SFP+ Flow Control default to Off rather than Rx/Tx Enable.

Solution: The Flow Control default setting for revision 1.6.x and newer has been changed to Rx Off and Tx Off because SFP+ devices do not support Autonegotiation for Flow Control.

Problem: On kernels older than 2.6.16 when 16 partitions are created on a server containing two BCM57711 network adapters, not all partitions would come up and an error indicating a shortage of space would display.

Solution: On architectures where the default vmalloc size is relatively small and not sufficient to load many interfaces, use `vmalloc=<size>` during boot to increase the size.

Problem: Routing does not work for NetXtreme II 10 GbE network adapters installed in Linux systems.

Solution: For NetXtreme II 10 GbE network adapters installed in systems with Linux kernels older than 2.6.26, disable TPA with either `ethtool` (if available) or with the driver parameter (see [disable_tpa](#)). Use `ethtool` to disable TPA (LRO) for a specific NetXtreme II 10 GbE network adapter.

Problem: On a NetXtreme II 1 GbE network adapter in a CNIC environment, flow control does not work.

Solution: Flow control is working, but in a CNIC environment, it has the appearance that it is not. The network adapter is capable of sending pause frames when the on-chip buffers are depleted, but the adapter also prevents the head-of-line blocking of other receive queues. Since the head-of-line blocking causes the on-chip firmware to discard packets inside the on-chip receive buffers, in the case a particular host queue is depleted, the on-chip receive buffers will rarely be depleted, therefore, it may appear that flow control is not functioning.

Problem: A `bnx2id` error appears when installing SLES 10 SP3 SBUU build 36.

Solution: `bnx2id` is a user space component that needs to be compiled at the time the package is installed. See your OS documentation for properly installing a compiler.

Problem: How do I disable `bnx2id` service on a system that does not have iSCSI enabled?

Solution: Type `service bnx2id stop`. Change the `bnx2id` runlevels to **off** using `chkconfig` or via the GUI.

Problem: How do I rebuild the `bnx2id` daemon after installing a compiler?

Solution: Change the directory to `/usr/src/netxtreme2-version/current/driver` and type `make install_usr`.

Problem: Errors appear when compiling driver source code.

Solution: Some installations of Linux distributions do not install the development tools by default. Ensure the development tools for the Linux distribution you are using are installed before compiling driver source code.

NPAR

Problem: The following error message displays if the storage configurations are not consistent for all four ports of the device in NPAR mode:

PXE-M1234: NPAR block contains invalid configuration during boot.

A software defect can cause the system to be unable to BFS boot to an iSCSI or FCoE target if an iSCSI personality is enabled on the first partition of one port, whereas an FCoE personality is enabled on the first partition of another port. The MBA driver performs a check for this configuration and prompts the user when it is found.

Solution: If using the 7.6.x firmware and driver, to workaround this error, configure the NPAR block such that if iSCSI or FCoE is enabled on the first partition, the same must be enabled on all partitions of all four ports of that device.

Kernel Debugging over Ethernet

Problem: When attempting to perform kernel debugging over an Ethernet network on a Windows 8.0 or Windows Server 2012 system, the system will not boot. This problem may occur with some adapters on systems where the Windows 8.0 or Windows Server 2012 OS is configured for UEFI mode. You may see a firmware error on screen, indicating that a Non Maskable Interrupt exception was encountered during the UEFI pre-boot environment.

Solution: Refer to the Microsoft knowledge base topic number 2920163, "[Non Maskable Interrupt error during boot on a system which has been configured for kernel debugging over Ethernet](#)".

Miscellaneous

Problem: The BCM57810 10 GbE NIC does not support 10 Gbps or 1 Gbps WOL link speed.

Solution: The BCM57810 10 GbE NIC can only support 100 Mbps WOL link speed due to power consumption limitations.

Problem: When setting the **Jumbo MTU** property to 5000 bytes or greater and forcing **Flow Control** on network adapters that support a link speed of 10 Gbps, the system performance performs at less than optimal levels.

Solution: If **Jumbo MTU** is set to 5000 bytes or greater, ensure that **Flow Control** is set to **Auto**.

Problem: iSCSI Crash Dump is not working in Windows.

Solution: After upgrading the device drivers using the installer, the iSCSI crash dump driver is also upgraded, and **iSCSI Crash Dump** must be re-enabled from the **Advanced** section of the **BACS Configuration** tab.

Problem: In Windows Server 2008 R2, if the OS is running as an iSCSI boot OS, the VolMgr error, "The system could not successfully load the crash dump driver," appears in the event log.

Solution: Enable **iSCSI Crash Dump** from the Advanced section of the **BACS Configuration** tab.

Problem: The Broadcom NetXtreme II adapter may not perform at optimal level on some systems if it is added after the system has booted.

Solution: The system BIOS in some systems does not set the cache line size and the latency timer if the adapter is added after the system has booted. Reboot the system after the adapter has been added.

Problem: Cannot configure Resource Reservations in BACS after SNP is uninstalled.

Solution: Reinstall SNP. Prior to uninstalling SNP from the system, ensure that NDIS is enabled via the checkbox on the Resource Configuration screen, available from the Resource Reservations section of the Configurations tab (see [Viewing and Configuring Resource Reservations](#)). If NDIS is disabled and SNP is removed, there is no access to re-enable the device.

Problem: The TOE status in the Vital Sign area of the BACS Information tab is inconsistent with the TOE status in the Resource Reservations tab when the TOE key is physically removed.

Solution: Reinstall the TOE key and navigate to the Resource Configuration screen from the Resource Reservations tab. Disable TOE from the Resource Configuration screen prior to removing the TOE key. The TOE status should be consistent in both the Vital Sign tab and the Resource Reservations tab.

Problem: TOE performance is more susceptible to packet loss when flow control is disabled.

Solution: Enable flow control to reduce the number of packets lost.

Problem: A DCOM error message (event ID 10016) appears in the System Event Log during the installation of the Broadcom adapter drivers.

Solution: This is a Microsoft issue. For more information, see Microsoft knowledge base KB913119 at <http://support.microsoft.com/kb/913119>.

Problem: Performance is degraded when multiple BCM57710 network adapters are used in a system.

Solution: Ensure that the system has at least 2 GB of main memory when using up to four network adapters and 4 GB of main memory when using four or more network adapters.

Problem: Remote installation of Windows Server 2008 to an iSCSI target via iSCSI offload fails to complete, and the computer restarts, repeatedly.

Solution: This is a Microsoft issue. For more information on applying the Microsoft hotfix, see Microsoft knowledge base article KB952942 at <http://support.microsoft.com/kb/952942>.

Problem: Performance drops when a BCM5709C network adapter is connected back-to-back to a switch, MTU = 9000, and Tx and Rx Flow Control are enabled.

Solution: When enable_cu_rate_limiter is enabled, the device performs flow control in the catchup path to prevent catchup frames from dropping. The catchup path is used in processing iSCSI out-of-order PDUs. When enable_cu_rate_limiter is disabled, there is a potential for some drops of iSCSI out-of-order PDUs, which reduces performance. This feature does not work well when jumbo frame is enabled on any of the client devices. Enable_cu_rate_limiter should be set to disabled when jumbo frame is enabled.

Problem: The network adapter has shut down and an error message appears indicating that the fan on the network adapter has failed.

Solution: The network adapter was shut down to prevent permanent damage. Contact Dell Support for assistance.

Problem: When using a BCM57840 4-port adapter in a blade server, ports 3 and 4 show no link.

Solution: The I/O (switch) module must support 32 internal ports. If it does not, ports 3 and 4 cannot establish a link.

Problem: When using a BCM57840 4-port adapter in a blade server, ports 3 and 4 show no link.

Solution: The I/O (switch) module must support 32 internal ports. If it does not, ports 3 and 4 cannot establish a link.

Please read all [Restrictions and Disclaimers](#).

[Back to Contents Page](#)